

DORMER PRAMET

ΚΑΤΑΛΟΓ
КАТАЛОГ
ΚΑΤΑΛΌΓ

2019



A	A976	102	C837	479	E282	319	EP10	275	H858	21	P707	508	S262	426
A002	A977	102	C907	456	E286	305	EP10TIN	275	H860	24	P709	510	S264	421
A002S	A978	102	C908	466	E287	295	EP11	275	H861	24	P711	512	S501	436
A022	B		C920	457	E288	285	EP20	290	J		P713	514	S511	439
A080	B100	158	C922	463	E289	263	EP21	290	J200	205	P715	516	S521	423
A087	B101	176	C948	467	E290	269	EP30	300	J205	205	P721	520	S523	424
A088	B121	178	D		E291	263	EP31	300	J210	206	P801	501	S524	422
A089	B122	166	D200	485	E292	263	EP40	321	J215	206	P801C	501	S525	417
A094	B157	173	D400	492	E293	264	EP41	321	J220	207	P803	503	S526	418
A095	B161	174	D402	493	E294	263	EX006G	252	J225	207	P803C	503	S527	419
A099	B170	170	D420	492	E295	265	EX006H	252	J235	208	P805	505	S529	433
A100	B180	168	D422	493	E296	265	EX00TIN	252	J245	209	P805C	505	S531	434
A101	B301	163	D745	486	E297	243	EX016H	252	J260	211	P807	507	S533	435
A108	B334	160	D747	488	E298	254	EX10	280	J280	210	P807C	507	S534	437
A110	B335	161	D750	491	E299	277	EX10TIN	280	K		P809	509	S535	438
A117	B400	152	D751	491	E300	282	EX11	280	K100	536	P811	511	S536	429
A119	B411	156	D752	490	E303	239	EX20	292	K101	536	P811C	511	S610	404
A120	B441	155	D753	490	E382	324	EX21	292	K102	536	P813	513	S611	405
A122	B442	157	D763	485	E383	283	EX30	302	K103	537	P813C	513	S612	410
A123	B481	153	E		E384	278	EX31	302	K104	537	P815	515	S629	440
A124	B901	162	E000	247	E390	234	EX40	323	K200	538	P815C	515	S637	402
A125	B903	164	E000TIN	247	E412	255	EX41	323	K201	538	P817	517	S638	403
A130	B952	165	E001	247	E414	258	F		K202	538	P819	518	S710	396
A147	B953	167	E002	260	E422	249	F100	355	K203	538	P819	518	S710	396
A160	B954	179	E002TIN	260	E423	249	F108	355	K204	538	P821	519	S713	398
A166	B955	180	E003	260	E471	246	F110	356	K300	533	P821C	519	S714	400
A170	B956	181	E011	279	E472	246	F120	357	K301	533	P823	521	S715	401
A188	B957	182	E013	284	E473	259	F130	358	K302	533	P825	522	S716	409
A190	C		E021	291	E474	259	F140	359	K303	533	P831	502	S717	413
A191	C110	443	E023	293	E500	235	F150	360	K304	533	P833	504	S718	414
A199	C122	454	E031	301	E501	235	F170	361	K305	533	P835	506	S739	441
A200	C123	445	E033	303	E504	235	F180	362	K310	534	P837	508	S740	441
A201	C126	443	E041	322	E513	271	F190	363	K311	534	P841	512	S761	415
A205	C135	447	E043	325	E515	288	F201	355	K312	534	P842	520	S763	425
A206	C139	445	E100	230	E524	298	F202	369	K313	534	P843	523	S765	420
A210	C159	451	E101	230	E531	308	F272	372	K314	534	P844	524	S766	416
A225	C167	453	E102	230	E533	311	F300	364	K330	535	P880	525	S767	428
A237	C246	458	E105	266	E534	310	F302	370	K520	539	P890	526	S802HA	390
A238	C247	458	E108	286	E536	312	F310	365	K521	540	R		S802HB	390
A242	C273	460	E111	296	E538	314	F312	371	K522	541	R100	30	S803HA	393
A243	C295	460	E115	307	E539	313	F320	366	L		R120	28	S803HB	393
A244	C299	456	E119	318	E542	315	F330	367	L000	342	R122	26	S804HA	406
A266	C305	450	E200	232	E544	317	F370	368	L001	343	R123	26	S804HB	406
A295	C306	448	E201	234	E545	316	G		L002	344	R200	25	S812HA	391
A296	C333	462	E207	250	E547	320	G106	189	L110	348	R453	40	S812HB	391
A345	C336	452	E212	250	E550	328	G107	192	L112	349	R454	40	S813HA	394
A350	C346	455	E216	249	E570	306	G125	198	L113	339	R457	36	S813HB	394
A400	C352	450	E225	287	E600	240	G129	187	L114	340	R458	36	S814HA	408
A402	C353	448	E229	297	E605	262	G132	194	L115	341	R459	44	S814HB	408
A405	C367	449	E237	232	E606	248	G135	184	L119	337	R463	50	S822	392
A412	C400	468	E238	257	E610	240	G136	189	L120	345	R467	47	S823	395
A413	C403	469	E239	257	E620	326	G137	185	L126	338	R510	34	S902	397
A510	C407	466	E240	245	E621	327	G138	195	M		R520	32	S903	399
A520	C413	468	E241	245	E650	261	G142	191	M150	542	R6011	26	S904	412
A530	C428	464	E242	269	E651	294	G149	188	M151	543	R7131	27	S922	397
A553	C492	465	E243	336	E653	332	G154	186	M152	544	R950	18	S933	399
A620	C500	470	E250	232	E654	304	G171	196	M200	545	R960	18	S944	412
A720	C505	471	E251	232	E708	335	G236	199	P		R970	18	S991	442
A723	C700	484	E252	234	E709	334	G314	197	P601	502	S		T	
A730	C710	483	E255	244	E710	330	G335	184	P605	506	S216	411	T200	226
A777	C800	472	E256	244	E711	331	G338	195	P607	508	S217	413	T201	226
A900	C801	475	E258	250	E712	333	G400	183	P609	510	S218	414	T205	228
A901	C810	473	E260	256	E714	329	G506	189	P611	512	S219	407	T206	228
A920	C820	477	E261	256	E720	334	G560	189	P613	514	S225	417	T210	226
A921	C822	476	E263	250	E721	330	G570	191	P615	516	S226	418	T215	229
A940	C825	474	E266	249	EP006G	241	G600	193	P621	520	S227	419		
A941	C830	481	E268	269	EP006H	241	H		P701	502	S229	430		
A951	C831	482	E275	287	EP00TIN	241	H853	21	P703	504	S231	431		
A952	C835	480	E278	297	EP016H	241	H855	21	P705	506	S233	432		
											S260	415		

003 - 142



143 - 200



201 - 212

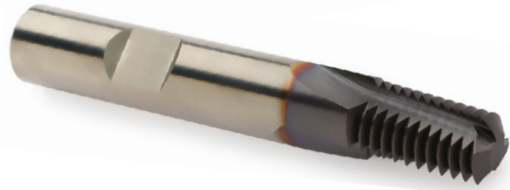

213 - 350



351 - 372



373 - 494



495 - 526



527 - 546

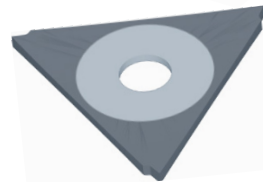

547 - 640



003 - 142



A002	69	A166	111	A405	120	H855	21
A002S	69	A170	80	A412	121	H858	21
A022	57	A188	140	A413	122	H860	24
A080	137	A190	138	A510	83	H861	24
A087	132	A191	139	A520	61	R100	30
A088	130	A199	136	A530	105	R120	28
A089	134	A200	123	A553	86	R122	26
A094	133	A201	125	A620	57	R123	26
A095	131	A205	123	A720	65	R200	25
A099	135	A206	123	A723	53	R453	40
A100	69	A210	124	A730	105	R454	40
A101	69	A225	126	A777	76	R457	36
A108	76	A237	127	A900	88	R458	36
A110	92	A238	128	A901	88	R459	44
A117	57	A242	129	A920	66	R463	50
A119	55	A243	91	A921	66	R467	47
A120	57	A244	91	A940	95	R510	34
A122	54	A266	123	A941	95	R520	32
A123	56	A295	141	A951	116	R6011	26
A124	64	A296	142	A952	116	R7131	27
A125	98	A345	114	A976	102	R950	18
A130	105	A350	112	A977	102	R960	18
A147	76	A400	118	A978	102	R970	18
A160	82	A402	119	H853	21		

Materiál	Материал	Materiał	Materiál
Standard	Стандарт	Standard	Štandard
Hĺoubka	Глубина	Głębokość	Hĺbka
Vrcholový úhel	Угол при вершине сверла	Kąt Ostrza	Vrcholový uhol
Povlak	Покрытие	Pokrycie	Povlak
Stopka	Хвостовик	Chwył	Stopka
Směr otáčení	Направление	Kierunek	Smer otáčania
Chlazení	СОЖ	Chłodziwo	Chladienie
<ul style="list-style-type: none"> ■ vynikající ● dobrý Příklad 10 = řezná rychlost (m/min) +/- 10%	Основное применение Возможное применение Пример: 10 = Скорость резания в м/мин +/- 10%	Najlepsze zastosowanie Dobre zastosowanie Na Przykład 10 = prędkość skrawania w m/min +/- 10%	Vynikajúce Dobré Příklad 10 = rezná rýchlosť (m/min) +/- 10%
Kód	Код	Kod	Kód
Rozměrová řada	Ассортимент	Zakres	Rozsah rozmerov

AMG	Česky	Русский	Polski	Slovensky
1.1	magneticky měkká	Автоматная сталь	magnetyczna miękka	Magneticky mäkká oceľ
1.2	konstrukční uhlíkatá	Низкоуглеродистая сталь	konstrukcyjna do nawęglania	Konstruktčná oceľ, uhlíková
1.3	uhlíkatá	Углеродистая нелегированная сталь	węglowa	Uhlíková oceľ
1.4	legovaná	Легированная сталь	stopowa	Legovaná oceľ
1.5	legovaná, tvrzená a temperovaná	Легированная сталь после отжига	stopowa-hartowana i odpuszczana	Legovaná oceľ, tvrdená a temperovaná
1.6	legovaná, tvrzená a temperovaná	Высоколегированная сталь после отжига	stopowa-hartowana i odpuszczana	Legovaná oceľ, tvrdená a temperovaná
1.7	legovaná, tvrzená	Легированная закаленная сталь	stopowa-hartowana	Legovaná oceľ tvrdená
1.8	legovaná, tvrzená	Легированная закаленная сталь	stopowa-hartowana	Legovaná oceľ tvrdená, oceľ odolná oproti opotrebovaniu
2.1	automatová	Ферритная нержавеющая сталь	automatowa	Automatová nehrdzavejúca oceľ
2.2	austenitická	Аустенитная нержавеющая сталь	austenitczna	Austenická
2.3	feritická+austenitická	Ферритно-аустенитная нержавеющая сталь	ferrytyczna+austenitczna	Feriticko austenitická nehr. oceľ (Duplex)
2.4	precipitačně tvrzená	Сталь дисперсионного твердения	Utwardzane wydzieleniowo	Tvrdená nehr. oceľ
3.1	lamelární	Серый чугун	szare	Sivá liatina
3.2	lamelární	Ковкий чугун	szare	Sivá liatina
3.3	nodulární	Высокопрочный чугун	sferoidalne ciagliwe	Tvárna liatina
3.4	nodulární	Высокопрочный чугун	sferoidalne ciagliwe	Tvárna liatina
4.1	čistý	Технически чистый титан	niestopowy	Čistý titán
4.2	slitiny	Титановые сплавы	stopy tytanu	Zliatiny titánu
4.3	slitiny	Титановые сплавы	stopy tytanu	Zliatiny titánu
5.1	čistý	Технически чистый никель	niestopowy	Čistý nikel
5.2	slitiny	Никелевые сплавы	stopy niklu	Zliatiny niklu
5.3	slitiny	Никелевые сплавы	stopy niklu	Zliatiny niklu
6.1	bronz	Технически чистая медь	niestopowa	Bronz
6.2	β - mosaz, bronz	Бронза	Mosiądz-β, brąz	β - mosadz, bronz
6.3	bronz mosaz	Латунь	Mosiądz CuZn	Mosadz, bronz
6.4	bronz vysokopevnostní	Высокопрочная бронза	Brąz o wysokiej wytrzymałości	Vysokopevnostný bronz
7.1	Al, Mg, tvářené	Технически чистый алюминий/магний	Al.,Mg, niestopowe	Al, Mg, tvárnený (čistý)
7.2	Al slitiny, Si<0.5%	Сплавы Al с содержанием Si<0.5%	Al. Stopowe, Si<0,5%	Al zliatiny, Si<0,5%
7.3	Al slitiny, Si>0.5%<10%	Сплавы Al с содержанием 0.5%<Si<10%	Al. Stopowe, Si>0,5%<10%	Al zliatiny, Si>0,5%<10%
7.4	Al slitiny, Si>10%	Сплавы Al с содержанием Si>10%	Al. Stopowe, Si>10%	Al zliatiny, Si>10%
8.1	termosty	Термопластики	Tworzywa termoplastyczne	Termoplasty
8.2	termosety	Термоактивные полимеры	Tworzywa termoutwardzalne	Termosety
8.3	zpevněné plasty	Армированные полимеры	Zbrojone tworzywa sztuczne	Spevnené plasty
9.1	cermet (keramika)	Металлокерамика	Cermetale	Cermet (kov-keramika)
10.1	standardni grafit	Технический графит	Grafit standartowy	Grafit

	HM	HM	HM	HSS	HSS	HSS			
				3XD	5XD	8XD			

Materiál	Материал	Materiał	Materiál
Standard	Стандарт	Standard	Štandard
Hĺoubka	Глубина	Głębokość	Hĺbka
Vrcholový úhel	Угол при вершине сверла	Kąt Ostrza	Vrcholový uhol
Povlak	Покрытие	Pokrycie	Povlak
Stopka	Хвостовик	Chwył	Stopka
Typ	Форма	Forma	Typ
Směr otáčení	Направление	Kierunek	Smer otáčania
Chlazení	СОЖ	Chłodziwo	Chladienie
Záhlubník, úhel	Угол зенковки	Kąt wierzchołkowy.	Záhlbník, uhol
<ul style="list-style-type: none"> ■ vynikající ● dobrý Příklad 10 = řezná rychlost (m/min) +/- 10%	Основное применение Возможное применение Пример: 10 = Скорость резания в м/мин +/- 10%	Najlepsze zastosowanie Dobre zastosowanie Na Przykład 10 = prędkość skrawania w m/min +/- 10%	Vynikajúce Dobré Příklad 10 = rezná rýchlosť (m/min) +/- 10%
Kód	Код	Kod	Kód
Rozměrová řada	Ассортимент	Zakres	Rozsah rozmerov

AMG	Česky	Русский	Polski	Slovensky
1.1	magneticky měkká	Автоматная сталь	magnetyczna miękka	Magneticky mäkká oceľ
1.2	konstrukční uhlíkatá	Низкоуглеродистая сталь	konstrukcyjna do nawęglania	Konstruktčná oceľ,uhlíková
1.3	uhlíkatá	Углеродистая нелегированная сталь	węglowa	Uhlíková oceľ
1.4	legovaná	Легированная сталь	stopowa	Legovaná oceľ
1.5	legovaná, tvrzená a temperovaná	Легированная сталь после отжига	stopowa-hartowana i odpuszczana	Legovaná oceľ, tvrdená a temperovaná
1.6	legovaná, tvrzená a temperovaná	Высоколегированная сталь после отжига	stopowa-hartowana i odpuszczana	Legovaná oceľ, tvrdená a temperovaná
1.7	legovaná, tvrzená	Легированная закаленная сталь	stopowa-hartowana	Legovaná oceľ tvrdená
1.8	legovaná, tvrzená	Легированная закаленная сталь	stopowa-hartowana	Legovaná oceľ tvrdená, oceľ odolná oproti opotrebovaniu
2.1	automatová	Ферритная нержавеющая сталь	automatowa	Automatová nehrdzavejúca oceľ
2.2	austenitická	Аустенитная нержавеющая сталь	austenityczna	Austenická
2.3	feritická+austenitická	Ферритно-аустенитная нержавеющая сталь	ferrytyczna+austenityczna	Feriticko austenitická nehr. oceľ (Duplex)
2.4	precipitačně tvrzená	Сталь дисперсионного твердения	Utwardzane wydzieleniowo	Tvrdená nehr. oceľ
3.1	lamelární	Серый чугун	szare	Sivá liatina
3.2	lamelární	Ковкий чугун	szare	Sivá liatina
3.3	nodulární	Высокопрочный чугун	sferoidalne ciągliwe	Tvárna liatina
3.4	nodulární	Высокопрочный чугун	sferoidalne ciągliwe	Tvárna liatina
4.1	čistý	Технически чистый титан	niestopowy	Čistý titán
4.2	slitiny	Титановые сплавы	stopy tytanu	Zliatiny titánu
4.3	slitiny	Титановые сплавы	stopy tytanu	Zliatiny titánu
5.1	čistý	Технически чистый никель	niestopowy	Čistý nikel
5.2	slitiny	Никелевые сплавы	stopy niklu	Zliatiny niklu
5.3	slitiny	Никелевые сплавы	stopy niklu	Zliatiny niklu
6.1	bronz	Технически чистая медь	niestopowa	Bronz
6.2	β - mosaz, bronz	Бронза	Mosiądz-β,brąz	β - mosadz, bronz
6.3	bronz mosaz	Латунь	Mosiądz CuZn	Mosadz, bronz
6.4	bronz vysokopevnostní	Высокопрочная бронза	Brąz o wysokiej wytrzymałości	Vysokopevnostný bronz
7.1	Al, Mg, tvářené	Технически чистый алюминий/магний	Al.,Mg, niestopowe	Al, Mg, tvárnený (čistý)
7.2	Al slitiny, Si<0.5%	Сплавы Al с содержанием Si<0.5%	Al. Stopowe,Si<0,5%	Al zliatiny, Si<0,5%
7.3	Al slitiny, Si>0.5%<10%	Сплавы Al с содержанием 0.5%<Si<10%	Al. Stopowe,Si>0,5%<10%	Al zliatiny, Si>0,5%<10%
7.4	Al slitiny, Si>10%	Сплавы Al с содержанием Si>10%	Al. Stopowe,Si>10%	Al zliatiny, Si>10%
8.1	termoplasty	Термопластики	Tworzywa termoplastyczne	Termoplasty
8.2	termosety	Терморезактивные полимеры	Tworzywa termoutwardzalne	Termosety
8.3	zpevněné plasty	Армированные полимеры	Zbrojone tworzywa sztuczne	Spevnené plasty
9.1	cermet (keramika)	Металлокерамика	Cermetale	Cermet (kov-keramika)
10.1	standardni grafit	Технический графит	Grafit standartowy	Grafit

	HM	HM	HM	HM	HM	HM	HM	HM	HM	HM	HM	HM	HM	HM	
	DIN 333A	DORMER	DORMER	DORMER	DORMER	DIN 6539	DIN 338	DIN 6539	DIN 338	DIN 6537 K	DIN 6537 K	DIN 6537 L	DIN 6537 L	DORMER	
	1XD	1XD	1XD	1XD	3XD	2.5XD	4XD	2.5XD	4XD	3XD	3XD	5XD	5XD	8XD	
	118°	120°	90°	90°	140°	120°	120°	130°	130°	140°	140°	140°	140°	140°	
		N	N	N	N	N	N	N	N						
	R200	R122	R123	R6011	R7131	R120	R100	CDX R520	CDX R510	FORCE X R458	FORCE X R457	FORCE X R454	FORCE X R453	FORCE X R459	
	1.00 - 5.00	5.00 - 20.00	5.00 - 20.00	6.00 - 16.00	3.30 - 10.40	1.00 - 12.00	1.00 - 14.00	3.00 - 16.50	3.00 - 14.25	3.00 - 20.00	3.00 - 20.00	3.00 - 20.00	3.00 - 20.00	3.00 - 16.00	
AMG	25	26	26	26	27	28	30	32	34	36	36	40	40	44	ISO
1.1	■50H	■85S	■85S	■110S	■120W	●85S	●85S	■100X	■100W	■155W	■155W	■155V	■155V	■135V	P 1
1.2	■48H	■75S	■75S	■90S	■110W	●75S	●75S	■90X	■90W	■135W	■140W	■135V	■140V	■120V	P 1
1.3	■45F	■75S	■75S	■90S	■105W	●75S	●75S	■90X	■90W	■110W	■135V	■110V	■135V	■110U	P 2
1.4	■40E	■70S	■70S	■75S	■85V	●70S	●70S	■80X	■80W	■100V	■115V	■100V	■115V	■100U	P 3
1.5	■30D	■45S	■45S	■55S	■65V	●45S	●45S	■55X	■55V	■75V	■90V	■75V	■90V	■80U	P 4
1.6	■10C	■45S	■45S	■50S		●45S	●45S	■45W	■45V	■50U	■65U	■50U	■65U	■55T	H 1
1.7		■30S	■30S	■30S		●30S	●30S	●35U	●35T	■30U	■30U	■30U	■30U		H 3
1.8		■30S	■30S	■30S		●30S	●30S	●30T	●30S	■25U	■25U	■25U	■25U		H 4
2.1		■53S	■53S	■60S	■45V			●50W	●50V	■45U	■55V	■45U	■55V	■75V	M 1
2.2		■45S	■45S	■50S	■40V					■40T	■35V	■40T	■35V	■35V	M 3
2.3					■35U					■35T	■30U	■35T	●30U	●30U	M 2
2.4										●35T		●35T	●30U		S 2
3.1	■40H	■75T	■75T	■80T	■90W	●75U	●75T	■90Y	■90X	■90W	■110W	■90W	■110W	■120W	K 1
3.2	■35E	■75T	■75T	■80T	■90W	●75U	●75T	■90Y	■90X	■90W	■110W	■90W	■110W	■120W	K 2
3.3	■30D	■55T	■55T	■70T	■75V	●55U	●55T	■65X	■65W	■70V	■80V	■70V	■80V	■80V	K 3
3.4	■30D	■55T	■55T	■70T	■65V	●55U	●55T	■65X	■65W	■70V	■80V	■70V	■80V	■80V	K 4
4.1		■45T	■45T	■55T		●45T		●60W	●45V	●50U	■55V	●50U	■55V		S 1
4.2		■35T	■35T	■45T		●35T		●45V		●40U	■45V	●40U	■45V		S 2
4.3		■25S	■25S	■35S		●25T		●35U		●35T	■40U	●35T	■40U		S 3
5.1		■45T	■45T	■55T		■40U		■50W	●50V						S 1
5.2		■30S	■30S	■40S		●30T									S 2
5.3		■20S	■20S	■30S		●20T									S 3
6.1	■110F	■275V	■275V	■275V	■125W	■275W				■100V	■125W	■100V	■125W	●125V	N 3
6.2	■100H	■250V	■250V	■250V	■220W	●275W	■250V			■200V	■220W	■200V	■220W	●220V	N 4
6.3	■90G	■250V	■250V	■250V	■220W	●275W	■250V			■200V	■220W	■200V	■220W	●220V	N 3
6.4	■75F	■70T	■70T	■70T	■100V	●70U				●80U	■100V	●80U	■100V	●100U	N 4
7.1	■120I	■200V	■200V	■200V	■250W	■200W	●200V	■225Z	■225Y	■225W	■250W	■225W	■250W	●285W	N 1
7.2	■110H	■200V	■200V	■200V	■250W	■200W	●200V	■225Z	■225Y	■225W	■250W	■225W	■250W	■285W	N 1
7.3	■100G	■112V	■112V	■112V	■200V	●112W	●112V	■150Y	■150X	■180V	■200V	■180V	■200V	■190V	N 1
7.4	■90G	■60V	■60V	■60V	■150V	●60W	●60V	■65Y	■65X	■120V	■150V	■120V	■150V	■95V	N 2
8.1		■60X	■60X	■60X		■60U	■60X	■75Z	■75X						O
8.2		■100V	■100V	■100V		■100U	■100V	■115V	■115V						O
8.3															O
9.1															H
10.1															O

	HM	HM	HSS-E	HSS	HSS	HSS	HSS	HSS	HSS-E	HSS-E	HSS	HSS HM	HSS-E	HSS-E	HSS-E	
	DIN 6537 K	DIN 6537 L	DORMER	DIN 1897	DIN 1897	DIN 1897	DIN 1897	DIN 1897	DIN ANSI	DIN 1897	DIN 1897	DIN 1897	DIN 1899	DIN 1899	DIN ANSI	DIN ANSI
	3XD	5XD	1XD	1XD	1.25XD	1.5XD	2.5XD	2.5XD	2.5XD	2.5XD	2.5XD	2.5XD	2.5XD	3XD	3XD	
	140°	140°		90° 120°	120°	120°	135°	135°	130°	135°	130°	118°	118°	130°	130°	
	TiAlN	TiAlN	Bronze		ST	ST	ST	TiN	Bronze	Bronze	TiN	ST			Alocrona Top	
	DIN 6535HA	DIN 6535HA														
	CTW™	CTW™	N	N	N	N	N	N	N	N		H	N	W	W	
	FORCE M	FORCE M									ADX				PFX	
	R467	R463	A723	A122	A119	A123	A120	A022	A620	A117	A520	A124	A720	A920	A921	
	3.00 - 16.00	3.00 - 16.00	6.00 - 8.00	6.00 - 20.00	3.30 - 5.10	3/32 - 1/4	0.50 - 25.00	0.50 - 16.00	2.50 - 13.00	1.00 - 13.00	3.00 - 13.00	3.00 - 16.00	0.15 - 1.40	1.00 - 20.00	2.50 - 16.00	
AMG	47	50	53	54	55	56	57	57	57	57	61	64	65	66	66	ISO
1.1			■35D	■35E	■35C	■35E	■35J	■35K	●38K	●38K	■57M		■35A	■40J	■60M	P 1
1.2			■30D	■30E	■27C	■30E	■30J	■32K	●33H	●33H	■47M		■30A	■34J	■52M	P 1
1.3			●25C	■27C	●23C	■27C	■27G	■25I	●30G	●30G	■40K		■27A	■32I	■53J	P 2
1.4			●20C	●21C	●20C	●21C	■21G	■23H	●27G	●27G	■32I		■23A	■32I	■53J	P 3
1.5				●14C	●8C	●14C	●14F	■16G	●18F	■18F	■21G	●40C	●17A	■23E	■38G	P 4
1.6				●10B	●7A	●10B	●10E	●10E	●11E	■11E	●11E	●37A	●10A	■19E	■30G	H 1
1.7																H 3
1.8																H 4
2.1	■85G	■85G		●16C	●15A	●16C	■16F	■15G	■22F	■22F	■30I		●22A	■15F	■17F	M 1
2.2	■75G	■75G		●9D	●7C	●9D	●9H	●8I	■11H	■11H	■16I	●35C	●10A	■7F	■9F	M 3
2.3	■60F	■60F		●10B	●10A	●10B	●10D	●9E	■15D	■15D	■20G	●35C	●15A	■9D	■11D	M 2
2.4	■60E	■60E														S 2
3.1				●32E			■32J	■32K	●34K	●34K	■48M	■55C	■30A	●34L	■53L	K 1
3.2				●27C			■27G	■25I	●30F	●30F	■37K	■43C	■24A	●26L	■42L	K 2
3.3				●20C			■20F	■20G	●22F	●22F	■30J	■40C	●20A	●26L	■42L	K 3
3.4				●16B			●16F	●16G	●17F	●17F	■26F	■32A	●14A	●19J	■36J	K 4
4.1	■55V	■55V		●27C	●27A	●27C	■27G	■25I	●30G	■30G	■34I	●40A	●23A	■30G	●48I	S 1
4.2	■45V	■45V		■12B	■12A	■12B	■16E	■14F	●18F	■18F	■20G	■35A	●17A	■18G	●29I	S 2
4.3	■40U	■40U		●7A	●7A	●7A	●8C	●8C	●10C	■10C	●4B	●25A	●8A	■10C	●16E	S 3
5.1	●55U	●55U		●13D	●9A	●13D	●13H	●13H	●15H	■15H	●17I	●30A	●10A	■15I	●24L	S 1
5.2	●45U	●45U		●8C	●4C	●8C	●8F	●8F	●9F	■9F	●11G	●25A	●7A	■9G	●14I	S 2
5.3	●40U	●40U		●4A	●3C	●4A	●4B	●4B	●6C	■6C	●7E	●20A	●4A	■6E	●10G	S 3
6.1				■27D	●27A	■27D	●36H	●36H	●38I	●38I	●40E		●35A	●65H		N 3
6.2				■33E	■33C	■33E	●38J	●38K	●40K	●40K	■50I	●70G	●40A	●66J		N 4
6.3				■27D	●27C	■27D	●27I	●27I	●27J	●27J	■45K	●60E	●35A	●40J	●71J	N 3
6.4				■16D	●16C	■16D	●16H	●16I	●16I	●16I	■20F	●50C	●27A	●31G	●50I	N 4
7.1				■33E	■33C	■33E	●33K	■40F	●40K	●35K	●55I		●35A	●75L		N 1
7.2				■30E	■30C	■30E	●30J	■32K	●35J	●33J	■50M		●30A	■45N		N 1
7.3				●30D	■30C	●30D	■30I	■32J	●32I	●31I	■37K		●27A	●40N		N 1
7.4				●25D	●25C	●25D	●25I	●25J	●30G	●30G	■35I		●27A	●36J	■48J	N 2
8.1				●30F	●30I	●30F	●30K	●30K	●40L	●35M	●65G		●48A	●55J		O
8.2				●35E	●35C	●35E	●35I	●35I	●32K	●28K	■50G	●60E	●25A	●40H		O
8.3				●17D		●17D	●17G	●17G	●18I	●17I	■35F					O
9.1				●12A		●12A	●4C	●4C			■6C		●9C			H
10.1																O

	HSS	HSS	HSS	HSS	HSS	HSS-E	HSS-E	HSS	HSS HM	HSS	HSS-E	HSS-E	HSS-E	HSS	HSS	HSS	
	DIN 338	DIN 338	DIN 338	DIN 338	DIN 338	DIN 338	DIN 338	DORMER	DIN 338	DIN 338	DORMER	DIN ANSI	DIN ANSI	NAS 907	NAS 907	DIN 340	
	4XD	4XD	4XD	4XD	4XD	6XD	4XD	4XD	4XD	4XD	5XD	6XD	6XD	4XD	4XD	6XD	
	118°	118°	118°	118°	135°	130°	135°	118°	118°	130°	130°	130°	130°	135°	118°	118°	
	TIN	TIN	ST	ST	ST		Bronze	ST	ST	TIN	TiAlN Top		Alcrona Top			ST	
											DIN 6535HA						
	N	N	N	N	W	VA	N	N	N			W	W	N	N	N	
								NAS 907J									
	002	002								ADX	ADX	PFX	PFX				
	A002	A002S	A100	A101	A108	A147	A777	A170	A160	A510	A553	A900	A901	A243	A244	A110	
	1.00 - 16.00	2.00 - 13.00	0.20 - 20.00	1.00 - 12.00	1.00 - 16.00	0.30 - 15.00	0.30 - 16.00	13.00 - 1.1/2	4.00 - 16.00	3.00 - 14.00	5.00 - 20.00	1.00 - 20.00	1.50 - 16.00	3/32 - 1/4	1/8 - 1/4	0.50 - 1"	
AMG	69	69	69	69	76	76	76	80	82	83	86	88	88	91	91	92	ISO
1.1	■47J	■47J	■35H	■35H	●35I	●35I	●35J	●35H	●60E	■57M	■85L	■38H	■60J			●27G	P 1
1.2	■40J	■40J	■30H	■30H	●30I	●30I	●30H	●30H	●60E	■47M	■70L	■33H	■50J			●25G	P 1
1.3	■35F	■35F	■25F	■25F	●25G	●25G	●27G	●25F	●55D	■40K	■60L	■26H	■44I	●25F	●25F	●20E	P 2
1.4	■30F	■30F	■20F	■20F	●20F	●20F	●24F	●20E	●50D	■30H	■45H	■26H	■44I	●20F	●20F	●16E	P 3
1.5	●18F	●18F	●13E	●13E	●13E	●13E	■17E	●13D	●40C	■21F	■28F	■21E	■33G	■13E	■13E	●9D	P 4
1.6	●10E	●10E	●9D	●9D	●9D	●9D	■10D	●9C	●37A	●11D	■15D	■16E	■26G	■9D	■9D	●6B	H 1
1.7																	H 3
1.8																	H 4
2.1	●20F	●20F	●15E	●15E	●15E	■15E	●22E	●15D	●40B	■28G	■40G	■15E	■17E	●15E	●15E	●10D	M 1
2.2	●12G	●12G	●8G	●8G	■9G	■9G	●11G	●7F	●35C	■14I	■19I	■7E	■9E	■8G	■8G	●6F	M 3
2.3	●16C	●16C	●9C	●9C	■10D	■10D	●15C	●7B	●35A	●19G	●27G	●9C	■11C	■9C	■9C	●4B	M 2
2.4						●7B											S 2
3.1	■40J	■40J	■30H	■30H	●30H	●30H	●35H	●27H	■50C	■42K	■70K	●24J	■58I	●30I	●30I	●28H	K 1
3.2	■30E	■30E	■24F	■24F	●24F	●24F	●28D	●22E	■40A	■32J	■50J	●19J	■47I	●24F	●24F	●21E	K 2
3.3	●28E	●28E	●20E	●20E	●20E	●20E	●22E	●19D	■35A	■28J	■45J	●19J	■34J	●20E	●20E	●15D	K 3
3.4	●26E	●26E	●14E	●14E	●14E	●14E	■17E	●12D	■30A	■25F	■42F	●14I	■28I	■14E	■14E	●13D	K 4
4.1	●23F	●23F	●23E	●23E	■25G	■25G	■28F	●17E	●35A	●32G	■45G	■22E	●35G	■23F	■23F	●17E	S 1
4.2	●13D	●13D	●12D	●12D	■16E	■16E	■20D	●9C	●35A	●20H	●30E	■15E	●24G	■12D	■12D	●9C	S 2
4.3	●7B	●7B	●6B	●6B	●7B	●7B	■11C	●5A	●25A	●4B	●8C	■6C	●10E	■6B	■6B	●4A	S 3
5.1	●13G	●13G	●10G	●10G	●12G	■12G	●15G	●8F	●30A	●17I	●25I	■14G	●22I	■10G	■10G	●8F	S 1
5.2	●7E	●7E	●6E	●6E	●7G	●7G	■7E	●4D	●25A	●9E	●15E	■7G	●11I	●6E	●6E	●4D	S 2
5.3	●3A	●3A	●3A	●3A	●6E	●6E	●6B	●3A	●20A	●6E	●10G	■6C	●10E	●3A	●3A	●3A	S 3
6.1	●50G	●50G	●33G	●33G	●33G	●33G	●38H	●35F	●55D	●40D	●70G	●65G				●30E	N 3
6.2	●33I	●33I	●35I	●35I	●35I	●35I	●40F	●33H	●70G	■50I	■85I	●53I				●32H	N 4
6.3	●39H	●39H	●27H	●27H	●31H	●31H	●27H	●27G	●60C	■45I	■80I	●34H	●56I	●27H	●27H	●27G	N 3
6.4	●30G	●30G	●16G	●16G	●16G	●16G	●21F	●16F	●50C	●20F	●35G	●30G	●48I	■16G	■16G	●16E	N 4
7.1	■41K	■41K	■33J	■33J	■33J	■33J	■33J	■33I	●50I	●50G	●70H	●60J				●32I	N 1
7.2	■38J	■38J	●30I	●30I	●30I	●30I	●30I	●30H	●45H	■50M	■100M	■45N				●27H	N 1
7.3	●33I	●33I	●27H	●27H	●27H	●27H	●27H	●27G	●40G	■31I	■55I	●40N				●27G	N 1
7.4	●33I	●33I	●24F	●24F	●24F	●24F	●27F	●22G	●35F	■33I	■55J	●28I	■48I	■24F	■24F	●25E	N 2
8.1	■30I	■30I	●30J	●30J	●30J	●30J		●30I		■65G	■90G	●55I				●35I	O
8.2	■50H	■50H	●28H	●28H	●28H	●28H		●28G	●60E	■50G		●40G				●26G	O
8.3	●35F	●35F	●14F	●14F	●14F	●14F		●14E		■35F						●12E	O
9.1	●3B	●3B	●3B	●3B	●3B	●3B	●6C	●3A	●9C					●3B	●3B	●3A	H
10.1																	O

	HSS-E	HSS-E	HSS	HSS-E	HSS-E	HSS-E	HSS	HSS	HSS-E	HSS HM	HSS	HSS	HSS	HSS	HSS
	DIN ANSI	DIN ANSI	BS 328	DIN 1869/1	DIN 1869/2	DIN 1869/3	DIN 345	DIN 345	DIN 345	DIN 345	DIN 341	DIN 1870/1	DIN 1870/1	DIN 1870/2	DIN 8374
	10XD	10XD	10XD	15XD	20XD	25XD	4XD	4XD	4XD	4XD	6XD	10XD	15XD	20XD	4XD
	130°	130°	118°	130°	130°	130°	118°	118°	118°	118°	118°	118°	130°	130°	118°
		Alcrona Top	ST				ST	TIN	Bronze	ST	ST	ST	ST	ST	ST
		W	N	W	W	W	N	N	N	N	N	N	W	W	N

	HSS	HSS	HSS	HSS	HSS	HSS	HSS-E	HSS-E	HSS	HSS	HSS	HSS-E	HSS-E	HSS-E	
	DIN 8376	DIN 8377	DORMER	DORMER	DIN 333A	DIN 333A	DIN 333A	DIN 333A	DIN 333R	DORMER	BS 328	DIN 333A	DIN 333R	DORMER	
	4XD	4XD	2.5XD	2.5XD	1XD	1XD	1XD	1XD	1XD	1XD	1XD	1XD	1XD	1XD	
	118°	118°	118°	118°	118°	118°	118°	118°	118°	122°	120°	118°	118°	118°	
	ST	ST	ST	ST		TIN		TiAlN							
	N	N													
	A402	A405	A412	A413	A200	A205	A206	A266	A210	A201	A225	A237	A238	A242	
	M3 - M10	M6 - M18	M3 - M10	M3 - M10	0.50 - 12.50	1.00 - 5.00	1.00 - 5.00	1.00 - 5.00	0.50 - 10.00	0.63 - 6.00	3/64 - 5/16	1.60 - 10.00	1.60 - 8.00	1.00 - 5.00	
AMG	119	120	121	122	123	123	123	123	124	125	126	127	128	129	ISO
1.1	■32G	■32G	■32I	■32I	■35I	■42I	■42I	■42I	■35I	■35I	■35I	■35I	■35I	■35I	P 1
1.2	■27G	■27G	■27I	■27I	■30I	■36I	■36I	■36I	■30I	■30I	■30I	■30I	■30I	■30I	P 1
1.3	■22E	■22E	■22G	■22G	■25G	■30G	■30G	■30G	■25G	■25G	■25G	■25G	■25G	■25G	P 2
1.4	■20E	■20E	■20G	■20G	■20F	■24F	■24F	■24F	■20F	■20F	■20F	■20F	■20F	■20F	P 3
1.5	●10C	●10C	●10E	●10E	●13E	●16E	●16E	●16E	●10E	●13E	●13E	●13E	●13E	●13E	P 4
1.6	●6C	●6C	●6C	●6C	●9D	●11D	●11D	●11D	●9D	●9D	●9D	●9D	●9D	●9D	H 1
1.7															H 3
1.8															H 4
2.1	●16E	●16E	■16G	■16G	●15E	●18E	●18E	●18E	●15E	●15E	●15E	●15E	●15E	●15E	M 1
2.2	●9G	●9G	●9I	●9I	●8G	●10G	●10G	●10G	●8G	●8G	●8G	●8G	●8G	●8G	M 3
2.3	●12C	●12C	●12E	●12E	●10C	●12C	●12C	●12C	●10C	●10C	●10C	●10C	●10C	●10C	M 2
2.4															S 2
3.1	■30G	■30G	■30G	■30G	■30I	■36I	■36I	■36I	■30I	■30I	■30I	■30I	■30I	■30I	K 1
3.2	■25E	■25E	■25E	■25E	■24F	■29F	■29F	■29F	■24F	■24F	■24F	■24F	■24F	■24F	K 2
3.3	●19E	●19E	●19E	●19E	●20E	●24E	●24E	●24E	●20E	●20E	●20E	●20E	●20E	●20E	K 3
3.4	●18C	●18C	●18E	●18E	●14E	●17E	●17E	●17E	●14E	●14E	●14E	●14E	●14E	●14E	K 4
4.1	●23E	●23E	●27G	●27G	●24F	●29F	●29F	●29F	●24F	●24F	●24F	●24F	●24F	●24F	S 1
4.2	●14C	●14C	●16E	●16E	●13D	●16D	●16D	●16D	●13D	●13D	●13D	●13D	●13D	●13D	S 2
4.3	●8A	●8A	●8C	●8C	●7B	●8B	●8B	●8B	●7B	●7B	●7B	●7B	●7B	●7B	S 3
5.1	●10G	●10G	●13I	●13I	●10G	●12G	●12G	●12G	●10G	●10G	●10G	●10G	●10G	●10G	S 1
5.2	●6C	●6C	●8G	●8G	●5E	●6E	●6E	●6E	●5E	●5E	●5E	●5E	●5E	●5E	S 2
5.3	●4A	●4A	●4C	●4C	●4A	●5A	●5A	●5A	●4A	●4A	●4A	●4A	●4A	●4A	S 3
6.1	●35E	●35E	●35G	●35G	●35G	●42G	●42G	●42G	●35G	●35G	●35G	●35G	●35G	●35G	N 3
6.2	●40E	●40E	●40G	●40G	●33I	●40I	●40I	●40I	●33I	●33I	●33I	●33I	●33I	●33I	N 4
6.3	●32E	●32E	●32G	●32G	●27H	●32H	●32H	●32H	●27H	●27H	●27H	●27H	●27H	●27H	N 3
6.4	●20E	●20E	●20G	●20G	●16G	●19G	●19G	●19G	●16G	●16G	●16G	●16G	●16G	●16G	N 4
7.1	●45E	●45E	●45G	●45G	●33J	●40J	●40J	●40J	●33J	●33J	●33J	●33J	●33J	●33J	N 1
7.2	●32E	●32E	●32G	●32G	●30I	●36I	●36I	●36I	●30I	●30I	●30I	●30I	●30I	●30I	N 1
7.3	●32E	●32E	●27G	●27G	●27H	●32H	●32H	●32H	●27H	●27H	●27H	●27H	●27H	●27H	N 1
7.4	●25E	●25E	●25G	●25G	●22H	●26H	●26H	●26H	●22H	●22H	●22H	●22H	●22H	●22H	N 2
8.1	●30I	●30I	●30I	●30I	●30J	●36J	●36J	●36J	●30J	●30J	●30J	●30J	●30J	●30J	O
8.2					●28H	●34H	●34H	●34H	●28H	●28H	●28H	●28H	●28H	●28H	O
8.3					●14F	●17F	●17F	●17F	●14F	●14F	●14F	●14F	●14F	●14F	O
9.1					●3B	●4B	●4B	●4B	●3B	●3B	●3B	●3B	●3B	●3B	H
10.1															O



A088
Set

A095
Set

A087
Set

A094
Set

A089
Set

A099
Set

A099
DRILLBOY

AMG	130	131	132	 133	134	135	135	ISO
1.1								P 1
1.2								P 1
1.3								P 2
1.4								P 3
1.5								P 4
1.6								H 1
1.7								H 3
1.8								H 4
2.1								M 1
2.2								M 3
2.3								M 2
2.4								S 2
3.1								K 1
3.2								K 2
3.3								K 3
3.4								K 4
4.1								S 1
4.2								S 2
4.3								S 3
5.1								S 1
5.2								S 2
5.3								S 3
6.1								N 3
6.2								N 4
6.3								N 3
6.4								N 4
7.1								N 1
7.2								N 1
7.3								N 1
7.4								N 2
8.1								O
8.2								O
8.3								O
9.1								H
10.1								O



A199
Set

A080
Set

A190
Set

A191
Set

A188
Set

A295
Set

A296
Set

AMG	136	137	 138	139	140	141	142	ISO
1.1								P 1
1.2								P 1
1.3								P 2
1.4								P 3
1.5								P 4
1.6								H 1
1.7								H 3
1.8								H 4
2.1								M 1
2.2								M 3
2.3								M 2
2.4								S 2
3.1								K 1
3.2								K 2
3.3								K 3
3.4								K 4
4.1								S 1
4.2								S 2
4.3								S 3
5.1								S 1
5.2								S 2
5.3								S 3
6.1								N 3
6.2								N 4
6.3								N 3
6.4								N 4
7.1								N 1
7.2								N 1
7.3								N 1
7.4								N 2
8.1								O
8.2								O
8.3								O
9.1								H
10.1								O

Fn	Material															
	HM	HSS HM	HSS	HSS-E												
Ø(D)	1mm	2mm	3mm	4mm	5mm	6mm	8mm	10mm	12mm	15mm	16mm	20mm	25mm	30mm	40mm	50mm
A	0.012	0.023	0.029	0.032	0.036	0.042	0.054	0.062	0.069	0.082	0.086	0.110	0.125	0.135	0.155	0.175
B	0.014	0.028	0.037	0.041	0.046	0.053	0.067	0.080	0.090	0.103	0.108	0.135	0.153	0.165	0.188	0.208
C	0.015	0.032	0.044	0.050	0.056	0.064	0.080	0.098	0.110	0.125	0.130	0.160	0.180	0.195	0.220	0.240
D	0.016	0.038	0.053	0.060	0.068	0.078	0.098	0.119	0.130	0.149	0.155	0.188	0.210	0.228	0.253	0.275
E	0.017	0.043	0.062	0.071	0.080	0.092	0.115	0.140	0.150	0.173	0.180	0.215	0.240	0.260	0.285	0.310
F	0.018	0.050	0.073	0.084	0.095	0.109	0.138	0.165	0.178	0.202	0.210	0.248	0.275	0.295	0.320	0.343
G	0.019	0.056	0.084	0.096	0.109	0.126	0.160	0.190	0.205	0.231	0.240	0.280	0.310	0.330	0.355	0.375
H	0.020	0.066	0.102	0.116	0.130	0.150	0.190	0.228	0.243	0.271	0.280	0.320	0.355	0.375	0.398	0.418
I	0.021	0.076	0.119	0.134	0.150	0.173	0.220	0.265	0.280	0.310	0.320	0.360	0.400	0.420	0.440	0.460
J	0.024	0.084	0.135	0.152	0.170	0.197	0.250	0.298	0.315	0.349	0.360	0.405	0.445	0.465	0.485	0.503
K	0.026	0.092	0.150	0.170	0.190	0.220	0.280	0.330	0.350	0.388	0.400	0.450	0.490	0.510	0.530	0.545
L	0.028	0.101	0.165	0.186	0.208	0.240	0.305	0.360	0.385	0.419	0.430	0.485	0.525	0.545	0.568	0.588
M	0.030	0.110	0.180	0.202	0.225	0.260	0.330	0.390	0.420	0.450	0.460	0.520	0.560	0.580	0.605	0.630
N	0.032	0.119	0.195	0.218	0.242	0.280	0.355	0.420	0.455	0.481	0.490	0.555	0.595	0.615	0.642	0.672
S	0.008	0.014	0.020	0.025	0.030	0.037	0.050	0.080	0.100	0.123	0.130	0.150				
T	0.015	0.028	0.040	0.050	0.060	0.070	0.090	0.110	0.130	0.160	0.170	0.190				
U	0.026	0.048	0.070	0.080	0.090	0.107	0.140	0.170	0.200	0.223	0.230	0.240				
V	0.038	0.069	0.100	0.115	0.130	0.153	0.200	0.250	0.280	0.310	0.320	0.340				
W	0.049	0.089	0.130	0.150	0.170	0.200	0.260	0.330	0.380	0.418	0.430	0.450				
X	0.056	0.103	0.150	0.180	0.210	0.250	0.330	0.420	0.480	0.533	0.550	0.580				
Y	0.068	0.124	0.180	0.220	0.260	0.317	0.430	0.550	0.700	0.700	0.700	0.740				
Z	0.094	0.172	0.250	0.325	0.400	0.533	0.800	1.000	1.100	1.175	1.200	1.200				

mm/N ± 25 %

$$n = \frac{V_c \times 1000}{\pi \times D}$$

$$V_f = n \times f \times n$$

Fn	Material						
	HM	HSS-E					
Ø(D)	12mm	15mm	16mm	20mm	25mm	30mm	40mm
S	0.100	0.123	0.130	0.150	0.170	0.190	0.220
T	0.130	0.160	0.170	0.190	0.210	0.230	0.260
U	0.200	0.223	0.230	0.240	0.270	0.300	0.360
V	0.280	0.310	0.320	0.340	0.400	0.440	0.510
W	0.380	0.418	0.430	0.450	0.470	0.490	0.520

mm/N ± 25 %

R950 R960 R970		18
H853 H855 H858		21
H860 H861		24



H861	H860	R950 R960 R970	H853 H855 H858
------	------	----------------------	----------------------

R950	R960	R970	H853	H855	H858	H860	H861
15/32 - 42.00	15/32 - 30.50	15/32 - 42.00	15/32 - 42.00	15/32 - 30.50	15/32 - 42.00	N1 - N7	N1 - N6

R950	R960	R970	H853	H855	H858	H860	H861
R95015/32	R96015/32	R97015/32					
R95012.0	R96012.0	R97012.0					
R95012.1	R96012.1	R97012.1	H85312.0	H85512.0	H85812.0		
R95012.2	R96012.2	R97012.2	H85331/64	H85531/64			
R95031/64	R96031/64	R97031/64					
R95012.5	R96012.5	R97012.5					
R95012.6	R96012.6	R97012.6	H85312.5	H85512.5	H85812.5	H860N1	H860N1
R9501/2	R9601/2	R9701/2	H8531/2	H8551/2			
R95012.8	R96012.8	R97012.8					
R95012.9	R96012.9	R97012.9					
R95013.0	R96013.0	R97013.0					
R95033/64	R96033/64	R97033/64	H85313.0	H85513.0	H85813.0		
R95013.2	R96013.2	R97013.2	H85317/32	H85517/32			
R95017/32	R96017/32	R97017/32					
R95013.5	R96013.5	R97013.5					
R95013.6	R96013.6	R97013.6					
R95013.7	R96013.7	R97013.7					
R95013.8	R96013.8	R97013.8					
R95035/64	R96035/64	R97035/64	H85314.0	H85514.0	H85814.0		
R95014.0	R96014.0	R97014.0	H8539/16	H8559/16			
R95014.1	R96014.1	R97014.1					
R95014.2	R96014.2	R97014.2					
R9509/16	R9609/16	R9709/16					
R95014.5	R96014.5	R97014.5					
R95014.6	R96014.6	R97014.6				H860N1	H861N1
R95037/64	R96037/64	R97037/64					
R95014.7	R96014.7	R97014.7					
R95014.8	R96014.8	R97014.8					
R95015.0	R96015.0	R97015.0	H85315.0	H85515.0	H85815.0		
R95019/32	R96019/32	R97019/32	H85339/64	H85539/64			
R95015.1	R96015.1	R97015.1					
R95015.2	R96015.2	R97015.2					
R95039/64	R96039/64	R97039/64					
R95015.5	R96015.5	R97015.5					

R950	R960	R970	H853	H855	H858	H860	H861
R95015.6	R96015.6	R97015.6					
R95015.7	R96015.7	R97015.7					
R9505/8	R9605/8	R9705/8					
R95016.0	R96016.0	R97016.0					
R95016.1	R96016.1	R97016.1	H85316.0	H85516.0	H85816.0		
R95016.2	R96016.2	R97016.2	H85341/64	H85541/64			
R95041/64	R96041/64	R97041/64					
R95016.5	R96016.5	R97016.5					
R95016.6	R96016.6	R97016.6					
R95021/32	R96021/32	R97021/32					
R95016.7	R96016.7	R97016.7					
R95017.0	R96017.0	R97017.0					
R95043/64	R96043/64	R97043/64	H85317.0	H85517.0	H85817.0	H860N2	H861N2
R95017.1	R96017.1	R97017.1	H85311/16	H85511/16			
R95017.2	R96017.2	R97017.2					
R95011/16	R96011/16	R97011/16					
R95017.5	R96017.5	R97017.5					
R95017.6	R96017.6	R97017.6					
R95017.7	R96017.7	R97017.7					
R95045/64	R96045/64	R97045/64					
R95018.0	R96018.0	R97018.0	H85318.0	H85518.0	H85818.0		
R95018.1	R96018.1	R97018.1	H85323/32	H85523/32			
R95018.2	R96018.2	R97018.2					
R95023/32	R96023/32	R97023/32					
R95018.5	R96018.5	R97018.5					
R95018.6	R96018.6	R97018.6					
R95047/64	R96047/64	R97047/64					
R95018.7	R96018.7	R97018.7					
R95018.9	R96018.9	R97018.9					
R95019.0	R96019.0	R97019.0					
R9503/4	R9603/4	R9703/4	H85319.0	H85519.0	H85819.0		
R95019.1	R96019.1	R97019.1	H85349/64	H85549/64			
R95019.2	R96019.2	R97019.2					
R95019.25	R96019.25	R97019.25					
R95049/64	R96049/64	R97049/64					
R95019.5	R96019.5	R97019.5				H860N3	H861N3
R95019.6	R96019.6	R97019.6					
R95019.7	R96019.7	R97019.7					
R95025/32	R96025/32	R97025/32	H85320.0	H85520.0	H85820.0		
R95020.0	R96020.0	R97020.0	H85351/64	H85551/64			
R95051/64	R96051/64	R97051/64					
R95020.5	R96020.5	R97020.5					
R95013/16	R96013/16	R97013/16					
R95021.0	R96021.0	R97021.0					
R95053/64	R96053/64	R97053/64	H85321.0	H85521.0	H85821.0		
R95027/32	R96027/32	R97027/32	H85327/32	H85527/32			
R95021.5	R96021.5	R97021.5					
R95055/64	R96055/64	R97055/64					
R95022.0	R96022.0	R97022.0					
R9507/8	R9607/8	R9707/8	H85322.0	H85522.0	H85822.0		
R95022.5	R96022.5	R97022.5	H85357/64	H85557/64			
R95057/64	R96057/64	R97057/64					
R95022.7	R96022.7	R97022.7					
R95023.0	R96023.0	R97023.0					
R95029/32	R96029/32	R97029/32	H85323.0	H85523.0	H85823.0	H860N4	H861N3
R95059/64	R96059/64	R97059/64	H85359/64	H85559/64			
R95023.5	R96023.5	R97023.5					
R95015/16	R96015/16	R97015/16					
R95024.0	R96024.0	R97024.0					
R95061/64	R96061/64	R97061/64	H85324.0	H85524.0	H85824.0		
R95024.5	R96024.5	R97024.5	H85331/32	H85531/32			
R95031/32	R96031/32	R97031/32					

R950	R960	R970	H853	H855	H858	H860	H861
R95025.0	R96025.0	R97025.0					
R95063/64	R96063/64	R97063/64					
R9501	R9601	R9701	H85325.0	H85525.0	H85825.0		
R95025.5	R96025.5	R97025.5	H8531.1/64	H8551.1/64			
R95025.65	R96025.65	R97025.65					
R9501.1/64	R9601.1/64	R9701.1/64					
R95026.0	R96026.0	R97026.0					
R9501.1/32	R9601.1/32	R9701.1/32	H85326.0	H85526.0	H85826.0	H860N5	H861N4
R95026.5	R96026.5	R97026.5	H8531.3/64	H8551.3/64			
R9501.3/64	R9601.3/64	R9701.3/64					
R9501.1/16	R9601.1/16	R9701.1/16					
R95027.0	R96027.0	R97027.0					
R9501.5/64	R9601.5/64	R9701.5/64	H85327.0	H85527.0	H85827.0		
R95027.5	R96027.5	R97027.5	H8531.3/32	H8551.3/32			
R9501.3/32	R9601.3/32	R9701.3/32					
R95028.0	R96028.0	R97028.0					
R9501.7/64	R9601.7/64	R9701.7/64	H85328.0	H85528.0	H85828.0		
R95028.5	R96028.5	R97028.5	H8531.1/8	H8551.1/8			
R9501.1/8	R9601.1/8	R9701.1/8					
R9501.9/64	R9601.9/64	R9701.9/64					
R95029.0	R96029.0	R97029.0					
R9501.5/32	R9601.5/32	R9701.5/32	H85329.0	H85529.0	H85829.0		
R95029.5	R96029.5	R97029.5	H8531.11/64	H8551.11/64			
R9501.11/64	R9601.11/64	R9701.11/64					
R95030.0	R96030.0	R97030.0					
R9501.3/16	R9601.3/16	R9701.3/16	H85330.0	H85530.0	H85830.0	H860N6	H861N5
R95030.5	R96030.5	R97030.5	H8531.3/16	H8551.3/16			
R9501.7/32		R9701.7/32					
R95031.0		R97031.0					
R9501.1/4		R9701.1/4	H85332.0	H85532.0	H85832.0		
R95032.0		R97032.0					
R95032.5		R97032.5					
R9501.19/64		R9701.19/64					
R95033.0		R97033.0	H85333.5	H85533.5	H85833.5		
R95033.5		R97033.5					
R95034.0		R97034.0					
R9501.11/32		R9701.11/32					
R95034.5		R97034.5	H85335.0	H85535.0	H85835.0		
R9501.3/8		R9701.3/8					
R95035.0		R97035.0					
R95036.0		R97036.0					
R9501.27/64		R9701.27/64	H85336.5	H85536.5	H85836.5		
R95036.5		R97036.5					
R95037.0		R97037.0					
R9501.15/32		R9701.15/32					
R95037.5		R97037.5	H85338.0	H85538.0	H85838.0		
R95038.0		R97038.0				H860N7	H861N6
R9501.1/2		R9701.1/2					
R95038.5		R97038.5					
R9501.17/32		R9701.17/32	H85339.5	H85539.5	H85839.5		
R95039.0		R97039.0					
R95039.5		R97039.5					
R9501.9/16		R9701.9/16					
R95040.0		R97040.0	H85341.0	H85541.0	H85841.0		
R95041.0		R97041.0					
R9501.5/8		R9701.5/8					
R95042.0		R97042.0	H85342.5	H85542.5	H85842.5		

R950

- Hydra, hlava na ocel
- Головки Hydra для стали
- Hydra głowiczka do stali
- Hydra hlava na oceľ

Tělo vrtáku obsahuje čtyři (4) šroubky H860 a jeden (1) šroubovák H861
 Четыре (4) винта H860 и одна (1) отвертка H861 входит в комплект вместе с корпусом сверла
 Cztery(4) wkręty H860 i jeden(1) wkrętak H861 są dołączone do wiertła
 Telo vrtáka obsahuje štyri skrutky H860 a jeden skrutkovač H861

R960

- Hydra, hlava na nerezavějící ocel
- Головки Hydra для нержавеющей стали
- Hydra głowiczka do stali nierdzewnej
- Hydra hlava na nehrdzavejúcu oceľ

Tělo vrtáku obsahuje čtyři (4) šroubky H860 a jeden (1) šroubovák H861
 Четыре (4) винта H860 и одна (1) отвертка H861 входит в комплект вместе с корпусом сверла
 Cztery(4) wkręty H860 i jeden(1) wkrętak H861 są dołączone do wiertła
 Telo vrtáka obsahuje štyri skrutky H860 a jeden skrutkovač H861

R970

- Hydra, hlava na litinu
- Головки Hydra для чугуна
- Hydra głowiczka do żeliwa
- Hydra hlava na liatinu

Tělo vrtáku obsahuje čtyři (4) šroubky H860 a jeden (1) šroubovák H861
 Четыре (4) винта H860 и одна (1) отвертка H861 входит в комплект вместе с корпусом сверла
 Cztery(4) wkręty H860 i jeden(1) wkrętak H861 są dołączone do wiertła
 Telo vrtáka obsahuje štyri skrutky H860 a jeden skrutkovač H861



R950	▪	1.3	1.4	1.5	1.6	3.3	3.4	
	•	1.1	1.2	2.4				
R960	▪	1.1	1.2	2.1	2.2	2.3	3.1	3.2
	•	2.4	3.3	3.4	4.1			
R970	▪	3.1	3.2	3.3	3.4			

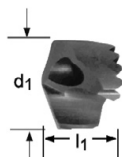

R950	R960	R970
15/32 - 42.00	15/32 - 30.50	15/32 - 42.00

d_1 $\varnothing h_7$ Inch	d_1 $\varnothing h_7$ mm	d_1 decimal Inch	l_1 mm	R950	R960	R970
15/32	11.91	0.4688	9.1	R95015/32	R96015/32	R97015/32
	12.00	0.4724	9.1	R95012.0	R96012.0	R97012.0
	12.10	0.4764	9.1	R95012.1	R96012.1	R97012.1
31/64	12.20	0.4803	9.1	R95012.2	R96012.2	R97012.2
	12.30	0.4844	9.1	R95031/64	R96031/64	R97031/64
	12.50	0.4921	9.4	R95012.5	R96012.5	R97012.5
1/2	12.60	0.4961	9.4	R95012.6	R96012.6	R97012.6
	12.70	0.5000	9.4	R9501/2	R9601/2	R9701/2
	12.80	0.5039	9.4	R95012.8	R96012.8	R97012.8
33/64	12.90	0.5079	9.4	R95012.9	R96012.9	R97012.9
	13.00	0.5118	9.7	R95013.0	R96013.0	R97013.0
	13.10	0.5156	9.7	R95033/64	R96033/64	R97033/64
17/32	13.20	0.5197	9.7	R95013.2	R96013.2	R97013.2
	13.49	0.5313	9.7	R95017/32	R96017/32	R97017/32
	13.50	0.5315	10.3	R95013.5	R96013.5	R97013.5
	13.60	0.5354	10.3	R95013.6	R96013.6	R97013.6
	13.70	0.5394	10.3	R95013.7	R96013.7	R97013.7
	13.80	0.5433	10.3	R95013.8	R96013.8	R97013.8

d ₁ Øh ₇ Inch	d ₁ Øh ₇ mm	d ₁ decimal Inch	l ₁ mm	R950	R960	R970
35/64	13.89	0.5469	10.3	R95035/64	R96035/64	R97035/64
	14.00	0.5512	10.3	R95014.0	R96014.0	R97014.0
	14.10	0.5551	10.3	R95014.1	R96014.1	R97014.1
	14.20	0.5591	10.3	R95014.2	R96014.2	R97014.2
9/16	14.29	0.5625	10.3	R9509/16	R9609/16	R9709/16
	14.50	0.5709	10.3	R95014.5	R96014.5	R97014.5
	14.60	0.5748	11.0	R95014.6	R96014.6	R97014.6
37/64	14.68	0.5781	11.0	R95037/64	R96037/64	R97037/64
	14.70	0.5787	11.0	R95014.7	R96014.7	R97014.7
	14.80	0.5827	11.0	R95014.8	R96014.8	R97014.8
	15.00	0.5906	11.0	R95015.0	R96015.0	R97015.0
19/32	15.08	0.5938	11.0	R95019/32	R96019/32	R97019/32
	15.10	0.5945	11.0	R95015.1	R96015.1	R97015.1
	15.20	0.5984	11.0	R95015.2	R96015.2	R97015.2
39/64	15.48	0.6094	11.0	R95039/64	R96039/64	R97039/64
	15.50	0.6102	11.0	R95015.5	R96015.5	R97015.5
	15.60	0.6142	11.6	R95015.6	R96015.6	R97015.6
	15.70	0.6181	11.6	R95015.7	R96015.7	R97015.7
5/8	15.88	0.6250	11.6	R9505/8	R9605/8	R9705/8
	16.00	0.6299	11.6	R95016.0	R96016.0	R97016.0
	16.10	0.6339	11.6	R95016.1	R96016.1	R97016.1
	16.20	0.6378	11.6	R95016.2	R96016.2	R97016.2
41/64	16.27	0.6406	11.6	R95041/64	R96041/64	R97041/64
	16.50	0.6496	11.6	R95016.5	R96016.5	R97016.5
	16.60	0.6535	12.2	R95016.6	R96016.6	R97016.6
21/32	16.67	0.6563	12.2	R95021/32	R96021/32	R97021/32
	16.70	0.6575	12.2	R95016.7	R96016.7	R97016.7
	17.00	0.6693	12.2	R95017.0	R96017.0	R97017.0
43/64	17.07	0.6719	12.2	R95043/64	R96043/64	R97043/64
	17.10	0.6732	12.2	R95017.1	R96017.1	R97017.1
	17.20	0.6772	12.2	R95017.2	R96017.2	R97017.2
11/16	17.46	0.6875	12.2	R95011/16	R96011/16	R97011/16
	17.50	0.6890	12.2	R95017.5	R96017.5	R97017.5
	17.60	0.6929	12.9	R95017.6	R96017.6	R97017.6
	17.70	0.6969	12.9	R95017.7	R96017.7	R97017.7
45/64	17.86	0.7031	12.9	R95045/64	R96045/64	R97045/64
	18.00	0.7087	12.9	R95018.0	R96018.0	R97018.0
	18.10	0.7126	12.9	R95018.1	R96018.1	R97018.1
	18.20	0.7165	12.9	R95018.2	R96018.2	R97018.2
23/32	18.26	0.7188	12.9	R95023/32	R96023/32	R97023/32
	18.50	0.7283	12.9	R95018.5	R96018.5	R97018.5
	18.60	0.7323	13.5	R95018.6	R96018.6	R97018.6
47/64	18.65	0.7344	13.5	R95047/64	R96047/64	R97047/64
	18.70	0.7362	13.5	R95018.7	R96018.7	R97018.7
	18.90	0.7441	13.5	R95018.9	R96018.9	R97018.9
	19.00	0.7480	13.5	R95019.0	R96019.0	R97019.0
3/4	19.05	0.7500	13.5	R9503/4	R9603/4	R9703/4
	19.10	0.7520	13.5	R95019.1	R96019.1	R97019.1
	19.20	0.7559	13.5	R95019.2	R96019.2	R97019.2
	19.25	0.7579	13.5	R95019.25	R96019.25	R97019.25
49/64	19.45	0.7656	13.5	R95049/64	R96049/64	R97049/64
	19.50	0.7677	13.5	R95019.5	R96019.5	R97019.5
	19.60	0.7717	14.1	R95019.6	R96019.6	R97019.6
	19.70	0.7756	14.1	R95019.7	R96019.7	R97019.7
25/32	19.84	0.7813	14.1	R95025/32	R96025/32	R97025/32
	20.00	0.7874	14.1	R95020.0	R96020.0	R97020.0
51/64	20.24	0.7969	14.1	R95051/64	R96051/64	R97051/64
	20.50	0.8071	14.1	R95020.5	R96020.5	R97020.5
13/16	20.64	0.8125	14.8	R95013/16	R96013/16	R97013/16
	21.00	0.8268	14.8	R95021.0	R96021.0	R97021.0
53/64	21.03	0.8281	14.8	R95053/64	R96053/64	R97053/64
	21.43	0.8438	14.8	R95027/32	R96027/32	R97027/32
27/32	21.50	0.8465	14.8	R95021.5	R96021.5	R97021.5
	21.83	0.8594	15.0	R95055/64	R96055/64	R97055/64
55/64	22.00	0.8661	15.0	R95022.0	R96022.0	R97022.0
	22.22	0.8750	15.0	R9507/8	R9607/8	R9707/8
7/8	22.50	0.8858	15.0	R95022.5	R96022.5	R97022.5
	22.62	0.8906	15.0	R95057/64	R96057/64	R97057/64
57/64	22.70	0.8937	15.0	R95022.7	R96022.7	R97022.7
	23.00	0.9055	15.1	R95023.0	R96023.0	R97023.0

d_1 $\varnothing h_7$ Inch	d_1 $\varnothing h_7$ mm	d_1 decimal Inch	l_1 mm	R950	R960	R970
29/32	23.02	0.9063	15.1	R95029/32	R96029/32	R97029/32
59/64	23.42	0.9219	15.1	R95059/64	R96059/64	R97059/64
	23.50	0.9252	15.1	R95023.5	R96023.5	R97023.5
15/16	23.81	0.9375	15.4	R95015/16	R96015/16	R97015/16
	24.00	0.9449	15.4	R95024.0	R96024.0	R97024.0
61/64	24.21	0.9531	15.4	R95061/64	R96061/64	R97061/64
	24.50	0.9646	15.4	R95024.5	R96024.5	R97024.5
31/32	24.61	0.9688	15.4	R95031/32	R96031/32	R97031/32
	25.00	0.9844	15.8	R95025.0	R96025.0	R97025.0
63/64	25.00	0.9844	15.8	R95063/64	R96063/64	R97063/64
1"	25.40	1.0000	15.8	R9501	R9601	R9701
	25.50	1.0039	15.8	R95025.5	R96025.5	R97025.5
	25.65	1.0098	15.8	R95025.65	R96025.65	R97025.65
1.1/64	25.80	1.0156	15.8	R9501.1/64	R9601.1/64	R9701.1/64
	26.00	1.0236	16.4	R95026.0	R96026.0	R97026.0
1.1/32	26.19	1.0313	16.4	R9501.1/32	R9601.1/32	R9701.1/32
	26.50	1.0433	16.4	R95026.5	R96026.5	R97026.5
1.3/64	26.59	1.0469	16.4	R9501.3/64	R9601.3/64	R9701.3/64
1.1/16	26.99	1.0625	17.1	R9501.1/16	R9601.1/16	R9701.1/16
	27.00	1.0630	17.1	R95027.0	R96027.0	R97027.0
1.5/64	27.38	1.0781	17.1	R9501.5/64	R9601.5/64	R9701.5/64
	27.50	1.0827	17.1	R95027.5	R96027.5	R97027.5
1.3/32	27.78	1.0938	17.1	R9501.3/32	R9601.3/32	R9701.3/32
	28.00	1.1024	17.7	R95028.0	R96028.0	R97028.0
1.7/64	28.18	1.1094	17.7	R9501.7/64	R9601.7/64	R9701.7/64
	28.50	1.1220	17.7	R95028.5	R96028.5	R97028.5
1.1/8	28.58	1.1250	17.7	R9501.1/8	R9601.1/8	R9701.1/8
1.9/64	28.97	1.1406	18.3	R9501.9/64	R9601.9/64	R9701.9/64
	29.00	1.1417	18.3	R95029.0	R96029.0	R97029.0
1.5/32	29.37	1.1563	18.3	R9501.5/32	R9601.5/32	R9701.5/32
	29.50	1.1614	18.3	R95029.5	R96029.5	R97029.5
1.11/64	29.77	1.1719	18.3	R9501.11/64	R9601.11/64	R9701.11/64
	30.00	1.1811	19.0	R95030.0	R96030.0	R97030.0
1.3/16	30.16	1.1875	19.0	R9501.3/16	R9601.3/16	R9701.3/16
	30.50	1.2008	19.0	R95030.5	R96030.5	R97030.5
1.7/32	30.96	1.2188	21.0	R9501.7/32		R9701.7/32
	31.00	1.2205	21.0	R95031.0		R97031.0
1.1/4	31.75	1.2500	21.0	R9501.1/4		R9701.1/4
	32.00	1.2598	21.0	R95032.0		R97032.0
	32.50	1.2795	21.0	R95032.5		R97032.5
	32.94	1.2969	21.0	R9501.19/64		R9701.19/64
1.19/64	33.00	1.2992	21.0	R95033.0		R97033.0
	33.50	1.3189	21.0	R95033.5		R97033.5
	34.00	1.3386	23.0	R95034.0		R97034.0
	34.13	1.3438	23.0	R9501.11/32		R9701.11/32
1.11/32	34.50	1.3583	23.0	R95034.5		R97034.5
	34.93	1.3750	23.0	R9501.3/8		R9701.3/8
1.3/8	35.00	1.3780	23.0	R95035.0		R97035.0
	36.00	1.4173	23.0	R95036.0		R97036.0
	36.12	1.4219	23.0	R9501.27/64		R9701.27/64
	36.50	1.4370	23.0	R95036.5		R97036.5
1.15/32	37.00	1.4567	25.0	R95037.0		R97037.0
	37.31	1.4688	25.0	R9501.15/32		R9701.15/32
	37.50	1.4764	25.0	R95037.5		R97037.5
	38.00	1.4961	25.0	R95038.0		R97038.0
1.1/2	38.10	1.5000	25.0	R9501.1/2		R9701.1/2
	38.50	1.5157	25.0	R95038.5		R97038.5
1.17/32	38.89	1.5313	25.0	R9501.17/32		R9701.17/32
	39.00	1.5354	25.0	R95039.0		R97039.0
	39.50	1.5551	25.0	R95039.5		R97039.5
1.9/16	39.69	1.5625	27.0	R9501.9/16		R9701.9/16
	40.00	1.5748	27.0	R95040.0		R97040.0
	41.00	1.6142	27.0	R95041.0		R97041.0
	41.28	1.6250	27.0	R9501.5/8		R9701.5/8
1.5/8	42.00	1.6535	27.0	R95042.0		R97042.0

H853

- Vrták Hydra tělo 3 x D
- Корпус Hydra для 3 x D
- Hydra Korpus 3 x D
- Vrták Hydra telo 3 x D

Tělo vrtáku obsahuje čtyři (4) šroubky H860 a jeden (1) šroubovák H861
 Четыре (4) винта H860 и одна (1) отвертка H861 входит в комплект вместе с корпусом сверла
 Cztery(4) wkręty H860 i jeden(1) wkrętak H861 są dołączone do wiertła
 Telo vrtáka obsahuje štyri skrutky H860 a jeden skrutkovač H861

H855

- Vrták Hydra tělo 5 x D
- Корпус Hydra для 5 x D
- Hydra Korpus 5 x D
- Vrták Hydra telo 5 x D

Tělo vrtáku obsahuje čtyři (4) šroubky H860 a jeden (1) šroubovák H861
 Четыре (4) винта H860 и одна (1) отвертка H861 входит в комплект вместе с корпусом сверла
 Cztery(4) wkręty H860 i jeden(1) wkrętak H861 są dołączone do wiertła
 Telo vrtáka obsahuje štyri skrutky H860 a jeden skrutkovač H861

H858

- Vrták Hydra tělo 8 x D
- Корпус Hydra для 8 x D
- Hydra Korpus 8 x D
- Vrták Hydra telo 8 x D

Tělo vrtáku obsahuje čtyři (4) šroubky H860 a jeden (1) šroubovák H861
 Четыре (4) винта H860 и одна (1) отвертка H861 входит в комплект вместе с корпусом сверла
 Cztery(4) wkręty H860 i jeden(1) wkrętak H861 są dołączone do wiertła
 Telo vrtáka obsahuje štyri skrutky H860 a jeden skrutkovač H861

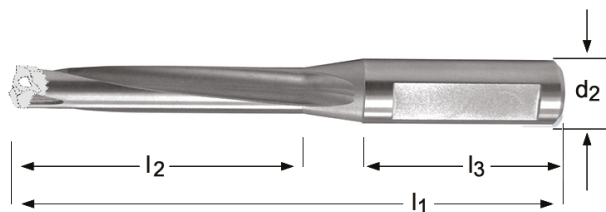
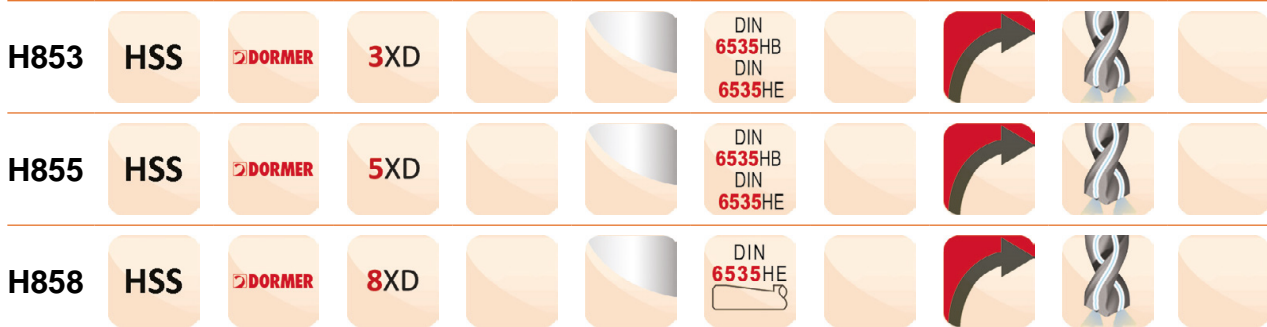

d_2 $\varnothing h_6$ Inch	d_2 $\varnothing h_6$ mm	l_2 mm	l_1 mm	l_3 mm	DIN 6535HB DIN 6535HE	H853	H855	H858
	16.00	44.0	105.0	48.0	DIN6535HE	H85312.0		
	16.00	69.0	130.0	48.0	DIN6535HE		H85512.0	
5/8	15.88	44.0	105.0	48.0	DIN6535HE	H85331/64		
5/8	15.88	69.0	130.0	48.0	DIN6535HE		H85531/64	
	16.00	44.0	105.0	48.0	DIN6535HE	H85312.5		
	16.00	69.0	130.0	48.0	DIN6535HE		H85512.5	
5/8	15.88	44.0	105.0	48.0	DIN6535HE	H8531/2		
5/8	15.88	69.0	130.0	48.0	DIN6535HE		H8551/2	
	16.00	47.0	110.0	48.0	DIN6535HE	H85313.0		
	16.00	74.0	140.0	48.0	DIN6535HE		H85513.0	
5/8	15.88	47.0	110.0	48.0	DIN6535HE	H85317/32		
5/8	15.88	74.0	140.0	48.0	DIN6535HE		H85517/32	
	16.00	124.5	191.5	48.0	DIN6535HE			H85814.0
	16.00	52.5	116.5	48.0	DIN6535HE	H85314.0		
	16.00	81.5	146.5	48.0	DIN6535HE		H85514.0	
3/4	19.05	52.5	116.5	48.0	DIN6535HE	H8539/16		
3/4	19.05	81.5	146.5	48.0	DIN6535HE		H8559/16	
	20.00	133.5	201.5	50.0	DIN6535HE			H85815.0
	20.00	55.5	126.5	50.0	DIN6535HE	H85315.0		
	20.00	86.5	156.5	50.0	DIN6535HE		H85515.0	
3/4	19.05	55.5	126.5	50.0	DIN6535HE	H85339/64		
3/4	19.05	86.5	156.5	50.0	DIN6535HE		H85539/64	

d_2 $\varnothing h_6$ Inch	d_2 $\varnothing h_6$ mm	l_2 mm	l_1 mm	l_3 mm	DIN 6535HB DIN 6535HE	H853	H855	H858
	20.00	141.5	211.5	50.0	DIN6535HE			H85816.0
	20.00	59.5	131.5	50.0	DIN6535HE	H85316.0		
	20.00	92.5	166.5	50.0	DIN6535HE		H85516.0	
3/4	19.05	59.5	131.5	50.0	DIN6535HE	H85341/64		
3/4	19.05	92.5	166.5	50.0	DIN6535HE		H85541/64	
	20.00	150.5	221.5	50.0	DIN6535HE			H85817.0
	20.00	62.5	136.5	50.0	DIN6535HE	H85317.0		
	20.00	97.5	171.5	50.0	DIN6535HE		H85517.0	
3/4	19.05	62.5	136.5	50.0	DIN6535HE	H85311/16		
3/4	19.05	97.5	171.5	50.0	DIN6535HE		H85511/16	
	20.00	158.5	226.5	50.0	DIN6535HE			H85818.0
	20.00	103.5	176.5	50.0	DIN6535HE		H85518.0	
	20.00	66.5	141.5	50.0	DIN6535HE	H85318.0		
3/4	19.05	103.5	176.5	50.0	DIN6535HE		H85523/32	
3/4	19.05	66.5	141.5	50.0	DIN6535HE	H85323/32		
	25.00	167.5	251.5	56.0	DIN6535HE			H85819.0
	25.00	108.5	191.5	56.0	DIN6535HE		H85519.0	
	25.00	69.5	156.5	56.0	DIN6535HE	H85319.0		
1"	25.40	108.5	191.5	56.0	DIN6535HE		H85549/64	
1"	25.40	69.5	156.5	56.0	DIN6535HE	H85349/64		
	25.00	175.5	264.5	56.0	DIN6535HE			H85820.0
	25.00	114.5	196.5	56.0	DIN6535HE		H85520.0	
	25.00	73.5	156.5	56.0	DIN6535HE	H85320.0		
1"	25.40	114.5	196.5	56.0	DIN6535HE		H85551/64	
1"	25.40	73.5	156.5	56.0	DIN6535HE	H85351/64		
	25.00	184.5	266.5	56.0	DIN6535HE			H85821.0
	25.00	119.5	196.5	56.0	DIN6535HE		H85521.0	
	25.00	76.5	156.5	56.0	DIN6535HE	H85321.0		
1"	25.40	119.5	196.5	56.0	DIN6535HE		H85527/32	
1"	25.40	76.5	156.5	56.0	DIN6535HE	H85327/32		
	25.00	192.1	271.1	56.0	DIN6535HE			H85822.0
	25.00	125.1	201.1	56.0	DIN6535HE		H85522.0	
	25.00	80.1	161.5	56.0	DIN6535HE	H85322.0		
1"	25.40	125.1	201.1	56.0	DIN6535HE		H85557/64	
1"	25.40	80.1	161.5	56.0	DIN6535HE	H85357/64		
	25.00	200.5	280.5	56.0	DIN6535HE			H85823.0
	25.00	129.5	210.5	56.0	DIN6535HE		H85523.0	
	25.00	82.5	160.5	56.0	DIN6535HE	H85323.0		
1"	25.40	129.5	210.5	56.0	DIN6535HE		H85559/64	
1"	25.40	82.5	160.5	56.0	DIN6535HE	H85359/64		
	32.00	208.2	295.2	60.0	DIN6535HE			H85824.0
	32.00	135.2	220.2	60.0	DIN6535HE		H85524.0	
	32.00	86.2	170.2	60.0	DIN6535HE	H85324.0		
1"	25.40	135.2	220.2	60.0	DIN6535HE		H85531/32	
1"	25.40	86.2	170.2	60.0	DIN6535HE	H85331/32		
	32.00	217.0	300.0	60.0	DIN6535HE			H85825.0
	32.00	140.0	225.0	60.0	DIN6535HE		H85525.0	
	32.00	88.0	170.0	60.0	DIN6535HE	H85325.0		
1.1/4	31.75	140.0	225.0	60.0	DIN6535HE		H8551.1/64	
1.1/4	31.75	88.0	170.0	60.0	DIN6535HE	H8531.1/64		
	32.00	225.0	310.0	60.0	DIN6535HE			H85826.0
	32.00	146.0	230.0	60.0	DIN6535HE		H85526.0	
	32.00	92.0	175.0	60.0	DIN6535HE	H85326.0		
1.1/4	31.75	146.0	230.0	60.0	DIN6535HE		H8551.3/64	
1.1/4	31.75	92.0	175.0	60.0	DIN6535HE	H8531.3/64		
	32.00	234.0	320.0	60.0	DIN6535HE			H85827.0
	32.00	151.0	235.0	60.0	DIN6535HE		H85527.0	
	32.00	94.0	175.0	60.0	DIN6535HE	H85327.0		
1.1/4	31.75	151.0	235.0	60.0	DIN6535HE		H8551.3/32	
1.1/4	31.75	94.0	175.0	60.0	DIN6535HE	H8531.3/32		
	32.00	242.0	325.0	60.0	DIN6535HE			H85828.0
	32.00	157.0	240.0	60.0	DIN6535HE		H85528.0	
	32.00	97.0	180.0	60.0	DIN6535HE	H85328.0		
1.1/4	31.75	157.0	240.0	60.0	DIN6535HE		H8551.1/8	
1.1/4	31.75	97.0	180.0	60.0	DIN6535HE	H8531.1/8		
	32.00	251.0	335.0	60.0	DIN6535HE			H85829.0
	32.00	100.0	185.0	60.0	DIN6535HE	H85329.0		
	32.00	162.0	245.0	60.0	DIN6535HE		H85529.0	
1.1/4	31.75	100.0	185.0	60.0	DIN6535HE	H8531.11/64		
1.1/4	31.75	162.0	245.0	60.0	DIN6535HE		H8551.11/64	
	32.00	259.0	345.0	60.0	DIN6535HE			H85830.0
	32.00	104.0	185.0	60.0	DIN6535HE	H85330.0		
	32.00	167.0	255.0	60.0	DIN6535HE		H85530.0	
1.1/4	31.75	104.0	185.0	60.0	DIN6535HE	H8531.3/16		
1.1/4	31.75	167.0	255.0	60.0	DIN6535HE		H8551.3/16	
	32.00	176.5	261.5	60.0	DIN6535HE		H85532.0	

d_2 $\varnothing h_6$ Inch	d_2 $\varnothing h_6$ mm	l_2 mm	l_1 mm	l_3 mm	DIN 6535HB DIN 6535HE	H853	H855	H858
	32.00	271.5	356.5	60.0	DIN6535HE			H85832.0
	32.00	111.5	196.5	60.0	DIN6535HE	H85332.0		
	40.00	186.5	271.5	60.0	DIN6535HB		H85533.5	
	40.00	286.5	371.5	60.0	DIN6535HB			H85833.5
	40.00	116.5	201.5	60.0	DIN6535HB	H85333.5		
	40.00	196.5	291.5	70.0	DIN6535HB		H85535.0	
	40.00	301.5	396.5	70.0	DIN6535HB			H85835.0
	40.00	121.5	216.5	70.0	DIN6535HB	H85335.0		
	40.00	201.5	296.5	70.0	DIN6535HB		H85536.5	
	40.00	311.5	406.5	70.0	DIN6535HB			H85836.5
	40.00	125.5	221.5	70.0	DIN6535HB	H85336.5		
	40.00	211.5	306.5	70.0	DIN6535HB		H85538.0	
	40.00	326.5	421.5	70.0	DIN6535HB			H85838.0
	40.00	131.5	226.5	70.0	DIN6535HB	H85338.0		
	40.00	221.5	316.5	70.0	DIN6535HB		H85539.5	
	40.00	336.5	431.5	70.0	DIN6535HB			H85839.5
	40.00	136.5	231.5	70.0	DIN6535HB	H85339.5		
	40.00	226.5	325.6	70.0	DIN6535HB		H85541.0	
	40.00	351.5	451.5	70.0	DIN6535HB			H85841.0
	40.00	146.5	246.5	70.0	DIN6535HB	H85341.0		
	40.00	236.5	336.5	70.0	DIN6535HB		H85542.5	
	40.00	361.5	461.5	70.0	DIN6535HB			H85842.5
	40.00	151.6	251.6	70.0	DIN6535HB	H85342.5		

- H860**
- Hydra šroubky Tělo vrtáku obsahuje čtyři (4) šroubky H860 a jeden (1) šroubovák H861
 - Hydra винты Четыре (4) винта H860 и одна (1) отвертка H861 входит в комплект вместе с корпусом сверла
 - Hydra śruby Cztery(4) wkręty H860 i jeden(1) wkrętak H861 są dołączone do wiertła
 - Hydra skrutky Telo vrtáka obsahuje štyri skrutky H860 a jeden skrutkovač H861

- H861**
- Hydra šroubovák Tělo vrtáku obsahuje čtyři (4) šroubky H860 a jeden (1) šroubovák H861
 - Hydra отвертка Четыре (4) винта H860 и одна (1) отвертка H861 входит в комплект вместе с корпусом сверла
 - Hydra wkrętak Cztery(4) wkręty H860 i jeden(1) wkrętak H861 są dołączone do wiertła
 - Hydra skrutkovač Telo vrtáka obsahuje štyri skrutky H860 a jeden skrutkovač H861



H860	H861
H860N7	H861N6
H860N6	H861N5
H860N5	H861N4
H860N4	H861N3
H860N3	H861N3
H860N2	H861N2
H860N1	H861N1

R200

- Středicí navrtávák - 60°
- Центровочное сверло - 60°
- Wiertło do nakiełków - 60°
- Strediací navrtávák - 60°

R200 ■ 1.1 1.2 1.3 1.4 1.5 1.6 3.1 3.2 3.3 3.4 6.1 6.2 6.3 6.4 7.1 7.2 7.3 7.4

R200 **HM** **DIN 333A** **1XD** **118°** **60°**

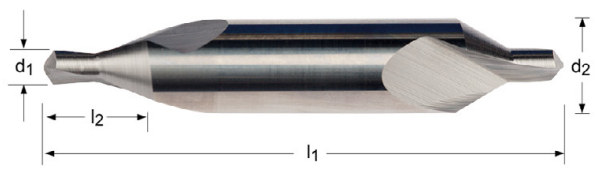

d_1 Ø mm	d_1 decimal Inch	l_2 max/min mm	l_1 mm	d_2 Ø mm	R200
1.00	0.0394	1.7 - 1.3	31	3.15	R2001.0X3.15
1.25	0.0492	2.0 - 1.6	31	3.15	R2001.25X3.15
1.60	0.0630	2.6 - 2.0	35	4.00	R2001.6X4.0
2.00	0.0787	3.1 - 2.5	40	5.00	R2002.0X5.0
2.50	0.0984	3.8 - 3.1	45	6.30	R2002.5X6.3
3.15	0.1240	4.6 - 3.9	50	8.00	R2003.15X8.0
4.00	0.1575	5.9 - 5.0	55	10.00	R2004.0X10.0
5.00	0.1969	7.2 - 6.3	63	12.50	R2005.0X12.5

R122

- Navrtávák - 120°
- Центровочное сверло для станков с ЧПУ - 120°
- Wiertło do nawiercania krótkie - 120°
- Navrtávák - 120°

4-fazetková špička až do 10,0mm
Стандартная заточка до 10,0 мм
Cztero płaszczyznowe ostrze do 10,0mm
4-fazetková špička až do 10,0 mm

R123

- Navrtávák - 90°
- Центровочное сверло для станков с ЧПУ - 90°
- Wiertło do nawiercania krótkie- 90°
- Navrtávák- 90°

4-fazetková špička až do 10,0mm
Стандартная заточка до 10,0 мм
Cztero płaszczyznowe ostrze do 10,0mm
4-fazetková špička až do 10,0 mm

R6011

- Navrtávák - 90°
- Центровочное сверло для станков с ЧПУ - 90°
- Wiertło do nawiercania - 90°
- Navrtávák - 90°

S TiAIN povlakem
С покрытием алюминитрид титана (TiAIN)
Powłoka TiAIN
TiAIN povlak

R122; R123; R6011	1.1	1.2	1.3	1.4	1.5	1.6	1.7	1.8	2.1	2.2	3.1	3.2	3.3	3.4	4.1	4.2
	4.3	5.1	5.2	5.3	6.1	6.2	6.3	6.4	7.1	7.2	7.3	7.4	8.1	8.2		

R122	HM	DORMER	1XD	120°			N			
R123	HM	DORMER	1XD	90°			N			
R6011	HM	DORMER	1XD	90°	TiAIN	DIN 6535HA	N			

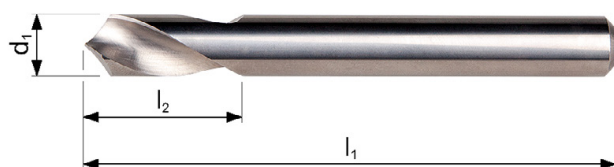

R122	R123	R6011
5.00 - 20.00	5.00 - 20.00	6.00 - 16.00

d ₁ Øh ₆ mm	d ₁ decimal Inch	l ₂ mm	l ₁ mm	R122	R123	R6011
5.00	0.1969	16	62	R1225.0	R1235.0	
6.00	0.2362	16	50			R60116.0
6.00	0.2362	17	66	R1226.0	R1236.0	
8.00	0.3150	22	79	R1228.0	R1238.0	
10.00	0.3937	25	70			R601110.0
10.00	0.3937	26	89	R12210.0	R12310.0	
12.00	0.4724	30	102	R12212.0	R12312.0	
16.00	0.6299	26	90			R601116.0
16.00	0.6299	34	115	R12216.0	R12316.0	
20.00	0.7874	40	131	R12220.0	R12320.0	

R7131

- Srážecí vrták pro otvory pod závit
- Сверло с зенковкой для предварительного нарезания резьбы в отверстиях
- Wiertło fazujące do otworów pod gwint
- Zrážací vrták pre otvory pod závit

R7131	▪	1.1	1.2	1.3	1.4	1.5	2.1	2.2	2.3	3.1	3.2	3.3	3.4	6.1	6.2	6.3	6.4	7.1	7.2
		7.3	7.4																

R7131 **HM** **3XD** **140°** **TiAIN** **DIN 6535HA** **N**

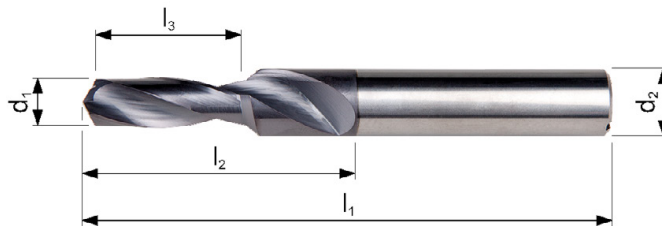

d_1 $\varnothing m_7$ mm	d_1 decimal Inch	l_3 mm	l_2 mm	l_1 mm	d_2 $\varnothing h_6$ mm	M	R7131
3.30	0.1299	11.4	20	66	6	M4	R71313.3
4.20	0.1654	13.6	24	66	6	M5	R71314.2
5.00	0.1969	16.5	28	79	8	M6	R71315.0
6.80	0.2677	21.0	34	89	10	M8	R71316.8
8.50	0.3346	25.5	47	102	12	M10	R71318.5
10.20	0.4016	30.0	55	107	14	M12	R713110.2
10.40	0.4094	30.0	55	107	14	M12	R713110.4

R120

- Navrtávák
- Спиральное сверло, укороченное исполнение
- Wiertło krótkie
- Navrtávák

R120	▪	4.1	5.1	6.1	7.1	8.1	8.2														
	•	1.1	1.2	1.3	1.4	1.5	1.6	1.7	1.8	3.1	3.2	3.3	3.4	4.2	4.3	5.2	5.3	6.2	6.3	6.4	7.2
		7.3	7.4																		

R120 **HM** **DIN 6539** **2.5XD** **120°**   **N**   

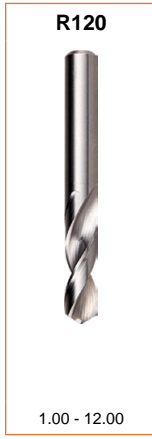
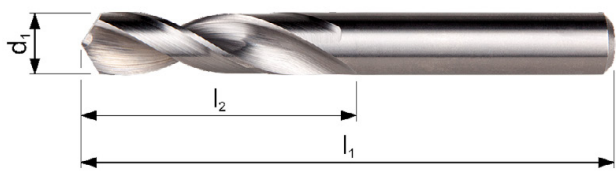

d_1 \varnothing_{h_7} mm	d_1 decimal Inch	l_2 mm	l_1 mm	R120
1.00	0.0394	6	26	R1201.0
1.10	0.0433	7	28	R1201.1
1.20	0.0472	8	30	R1201.2
1.30	0.0512	8	30	R1201.3
1.40	0.0551	9	32	R1201.4
1.50	0.0591	9	32	R1201.5
1.60	0.0630	10	34	R1201.6
1.70	0.0669	10	34	R1201.7
1.80	0.0709	11	36	R1201.8
1.90	0.0748	11	36	R1201.9
2.00	0.0787	12	38	R1202.0
2.10	0.0827	12	38	R1202.1
2.20	0.0866	13	40	R1202.2
2.30	0.0906	13	40	R1202.3
2.40	0.0945	14	43	R1202.4
2.50	0.0984	14	43	R1202.5
2.60	0.1024	14	43	R1202.6
2.70	0.1063	16	46	R1202.7
2.80	0.1102	16	46	R1202.8
2.90	0.1142	16	46	R1202.9
3.00	0.1181	16	46	R1203.0
3.10	0.1220	18	49	R1203.1
3.20	0.1260	18	49	R1203.2
3.30	0.1299	18	49	R1203.3
3.40	0.1339	20	52	R1203.4
3.50	0.1378	20	52	R1203.5
3.60	0.1417	20	52	R1203.6
3.70	0.1457	20	52	R1203.7
3.80	0.1496	22	55	R1203.8
3.90	0.1535	22	55	R1203.9
4.00	0.1575	22	55	R1204.0
4.10	0.1614	22	55	R1204.1
4.20	0.1654	22	55	R1204.2
4.30	0.1693	24	58	R1204.3
4.40	0.1732	24	58	R1204.4
4.50	0.1772	24	58	R1204.5
4.60	0.1811	24	58	R1204.6
4.70	0.1850	24	58	R1204.7

d₁ Øh₇ mm	d₁ decimal Inch	l₂ mm	l₁ mm	R120
4.80	0.1890	26	62	R1204.8
4.90	0.1929	26	62	R1204.9
5.00	0.1969	26	62	R1205.0
5.10	0.2008	26	62	R1205.1
5.20	0.2047	26	62	R1205.2
5.30	0.2087	26	62	R1205.3
5.40	0.2126	28	66	R1205.4
5.50	0.2165	28	66	R1205.5
5.60	0.2205	28	66	R1205.6
5.70	0.2244	28	66	R1205.7
5.80	0.2283	28	66	R1205.8
5.90	0.2323	28	66	R1205.9
6.00	0.2362	28	66	R1206.0
6.10	0.2402	31	70	R1206.1
6.20	0.2441	31	70	R1206.2
6.30	0.2480	31	70	R1206.3
6.40	0.2520	31	70	R1206.4
6.50	0.2559	31	70	R1206.5
6.60	0.2598	31	70	R1206.6
6.70	0.2638	31	70	R1206.7
6.80	0.2677	34	74	R1206.8
6.90	0.2717	34	74	R1206.9
7.00	0.2756	34	74	R1207.0
7.10	0.2795	34	74	R1207.1
7.20	0.2835	34	74	R1207.2
7.30	0.2874	34	74	R1207.3
7.40	0.2913	34	74	R1207.4
7.50	0.2953	34	74	R1207.5
7.60	0.2992	37	79	R1207.6
7.70	0.3031	37	79	R1207.7
7.80	0.3071	37	79	R1207.8
7.90	0.3110	37	79	R1207.9
8.00	0.3150	37	79	R1208.0
8.10	0.3189	37	79	R1208.1
8.20	0.3228	37	79	R1208.2
8.30	0.3268	37	79	R1208.3
8.40	0.3307	37	79	R1208.4
8.50	0.3346	37	79	R1208.5
8.60	0.3386	40	84	R1208.6
8.70	0.3425	40	84	R1208.7
8.80	0.3465	40	84	R1208.8
8.90	0.3504	40	84	R1208.9
9.00	0.3543	40	84	R1209.0
9.10	0.3583	40	84	R1209.1
9.20	0.3622	40	84	R1209.2
9.30	0.3661	40	84	R1209.3
9.40	0.3701	40	84	R1209.4
9.50	0.3740	40	84	R1209.5
9.60	0.3780	43	89	R1209.6
9.70	0.3819	43	89	R1209.7
9.80	0.3858	43	89	R1209.8
9.90	0.3898	43	89	R1209.9
10.00	0.3937	43	89	R12010.0
10.20	0.4016	43	89	R12010.2
10.50	0.4134	43	89	R12010.5
11.00	0.4331	47	95	R12011.0
11.50	0.4528	47	95	R12011.5
12.00	0.4724	51	102	R12012.0

- R100**
- Vrták zákl. délka
 - Спиральное сверло, короткое исполнение
 - Wiertło ogólnego stosowania
 - Vrták základná dĺžka

R100 ■ 6.2 6.3 8.1 8.2
 • 1.1 1.2 1.3 1.4 1.5 1.6 1.7 1.8 3.1 3.2 3.3 3.4 7.1 7.2 7.3 7.4

R100 HM DIN 338 4XD 120° N

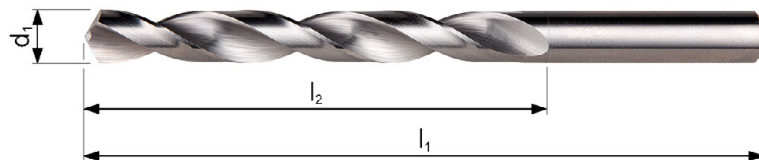

R100



1.00 - 14.00

d_1 \varnothing_{h_7} mm	d_1 decimal inch	l_2 mm	l_1 mm	R100
1.00	0.0394	12	34	R1001.0
1.10	0.0433	14	36	R1001.1
1.20	0.0472	16	38	R1001.2
1.30	0.0512	16	38	R1001.3
1.40	0.0551	18	40	R1001.4
1.50	0.0591	18	40	R1001.5
1.60	0.0630	20	43	R1001.6
1.70	0.0669	20	43	R1001.7
1.80	0.0709	22	46	R1001.8
1.90	0.0748	22	46	R1001.9
2.00	0.0787	24	49	R1002.0
2.10	0.0827	24	49	R1002.1
2.20	0.0866	27	53	R1002.2
2.30	0.0906	27	53	R1002.3
2.40	0.0945	30	57	R1002.4
2.50	0.0984	30	57	R1002.5
2.60	0.1024	30	57	R1002.6
2.70	0.1063	33	61	R1002.7
2.80	0.1102	33	61	R1002.8
2.90	0.1142	33	61	R1002.9
3.00	0.1181	33	61	R1003.0
3.10	0.1220	36	65	R1003.1
3.20	0.1260	36	65	R1003.2
3.30	0.1299	36	65	R1003.3
3.40	0.1339	39	70	R1003.4
3.50	0.1378	39	70	R1003.5
3.60	0.1417	39	70	R1003.6
3.70	0.1457	39	70	R1003.7
3.80	0.1496	43	75	R1003.8
3.90	0.1535	43	75	R1003.9
4.00	0.1575	43	75	R1004.0
4.10	0.1614	43	75	R1004.1
4.20	0.1654	43	75	R1004.2
4.30	0.1693	47	80	R1004.3
4.40	0.1732	47	80	R1004.4
4.50	0.1772	47	80	R1004.5
4.60	0.1811	47	80	R1004.6
4.70	0.1850	47	80	R1004.7

d₁ Øh₇ mm	d₁ decimal Inch	l₂ mm	l₁ mm	R100
4.80	0.1890	52	86	R1004.8
4.90	0.1929	52	86	R1004.9
5.00	0.1969	52	86	R1005.0
5.10	0.2008	52	86	R1005.1
5.20	0.2047	52	86	R1005.2
5.30	0.2087	52	86	R1005.3
5.40	0.2126	57	93	R1005.4
5.50	0.2165	57	93	R1005.5
5.60	0.2205	57	93	R1005.6
5.70	0.2244	57	93	R1005.7
5.80	0.2283	57	93	R1005.8
5.90	0.2323	57	93	R1005.9
6.00	0.2362	57	93	R1006.0
6.10	0.2402	63	101	R1006.1
6.20	0.2441	63	101	R1006.2
6.30	0.2480	63	101	R1006.3
6.40	0.2520	63	101	R1006.4
6.50	0.2559	63	101	R1006.5
6.60	0.2598	63	101	R1006.6
6.70	0.2638	63	101	R1006.7
6.80	0.2677	69	109	R1006.8
6.90	0.2717	69	109	R1006.9
7.00	0.2756	69	109	R1007.0
7.10	0.2795	69	109	R1007.1
7.20	0.2835	69	109	R1007.2
7.30	0.2874	69	109	R1007.3
7.40	0.2913	69	109	R1007.4
7.50	0.2953	69	109	R1007.5
7.60	0.2992	75	117	R1007.6
7.70	0.3031	75	117	R1007.7
7.80	0.3071	75	117	R1007.8
7.90	0.3110	75	117	R1007.9
8.00	0.3150	75	117	R1008.0
8.10	0.3189	75	117	R1008.1
8.20	0.3228	75	117	R1008.2
8.30	0.3268	75	117	R1008.3
8.40	0.3307	75	117	R1008.4
8.50	0.3346	75	117	R1008.5
8.60	0.3386	81	125	R1008.6
8.70	0.3425	81	125	R1008.7
8.80	0.3465	81	125	R1008.8
8.90	0.3504	81	125	R1008.9
9.00	0.3543	81	125	R1009.0
9.10	0.3583	81	125	R1009.1
9.20	0.3622	81	125	R1009.2
9.30	0.3661	81	125	R1009.3
9.40	0.3701	81	125	R1009.4
9.50	0.3740	81	125	R1009.5
9.60	0.3780	87	133	R1009.6
9.70	0.3819	87	133	R1009.7
9.80	0.3858	87	133	R1009.8
9.90	0.3898	87	133	R1009.9
10.00	0.3937	87	133	R10010.0
10.20	0.4016	87	133	R10010.2
10.50	0.4134	87	133	R10010.5
11.00	0.4331	94	142	R10011.0
11.50	0.4528	94	142	R10011.5
12.00	0.4724	101	151	R10012.0
13.00	0.5118	101	151	R10013.0
14.00	0.5512	108	160	R10014.0

R520

- CDX vrták
- Сверло CDX, укороченное исполнение
- Wiertło typu CDX krótkie
- CDX vrták krátky

R520	▪	1.1	1.2	1.3	1.4	1.5	1.6	3.1	3.2	3.3	3.4	5.1	7.1	7.2	7.3	7.4	8.1	8.2
	•	1.7	1.8	2.1	4.1	4.2	4.3											

R520	HM	DIN 6539	2.5XD	130°	TiN		N			
------	----	----------	-------	------	-----	--	---	--	--	--

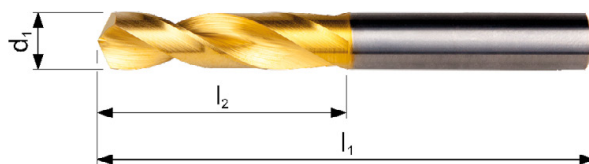

d_1 \varnothing_{h_7} Inch	d_1 \varnothing_{h_7} mm	d_1 decimal Inch	l_2 mm	l_1 mm	R520
1/8	3.00	0.1181	16	46	R5203.0
	3.10	0.1220	18	49	R5203.1
	3.18	0.1252	18	49	R5201/8
	3.20	0.1260	18	49	R5203.2
	3.30	0.1299	18	49	R5203.3
	3.40	0.1339	20	52	R5203.4
	3.50	0.1378	20	52	R5203.5
	3.60	0.1417	20	52	R5203.6
	3.70	0.1457	20	52	R5203.7
	3.80	0.1496	22	55	R5203.8
	3.90	0.1535	22	55	R5203.9
	4.00	0.1575	22	55	R5204.0
	4.10	0.1614	22	55	R5204.1
	4.20	0.1654	22	55	R5204.2
	4.30	0.1693	24	58	R5204.3
	4.40	0.1732	24	58	R5204.4
	4.50	0.1772	24	58	R5204.5
	4.60	0.1811	24	58	R5204.6
4.70	0.1850	24	58	R5204.7	
4.80	0.1890	26	62	R5204.8	
4.90	0.1929	26	62	R5204.9	
5.00	0.1969	26	62	R5205.0	
5.10	0.2008	26	62	R5205.1	
5.20	0.2047	26	62	R5205.2	
5.30	0.2087	26	62	R5205.3	
5.40	0.2126	28	66	R5205.4	
5.50	0.2165	28	66	R5205.5	
5.60	0.2205	28	66	R5205.6	
5.70	0.2244	28	66	R5205.7	
5.80	0.2283	28	66	R5205.8	
5.90	0.2323	28	66	R5205.9	
6.00	0.2362	28	66	R5206.0	
6.10	0.2402	31	70	R5206.1	
6.20	0.2441	31	70	R5206.2	
6.30	0.2480	31	70	R5206.3	
1/4	6.35	0.2500	31	70	R5201/4
	6.40	0.2520	31	70	R5206.4
	6.50	0.2559	31	70	R5206.5

d₁ Øh₇ Inch	d₁ Øh₇ mm	d₁ decimal Inch	l₂ mm	l₁ mm	R520
	6.60	0.2598	31	70	R5206.6
	6.70	0.2638	31	70	R5206.7
	6.80	0.2677	34	74	R5206.8
	6.90	0.2717	34	74	R5206.9
	7.00	0.2756	34	74	R5207.0
	7.10	0.2795	34	74	R5207.1
	7.20	0.2835	34	74	R5207.2
	7.30	0.2874	34	74	R5207.3
	7.40	0.2913	34	74	R5207.4
	7.50	0.2953	34	74	R5207.5
	7.60	0.2992	37	79	R5207.6
	7.70	0.3031	37	79	R5207.7
	7.80	0.3071	37	79	R5207.8
	7.90	0.3110	37	79	R5207.9
5/16	7.94	0.3126	37	79	R5205/16
	8.00	0.3150	37	79	R5208.0
	8.10	0.3189	37	79	R5208.1
	8.20	0.3228	37	79	R5208.2
	8.30	0.3268	37	79	R5208.3
	8.40	0.3307	37	79	R5208.4
	8.50	0.3346	37	79	R5208.5
	8.60	0.3386	40	84	R5208.6
	8.70	0.3425	40	84	R5208.7
	8.80	0.3465	40	84	R5208.8
	8.90	0.3504	40	84	R5208.9
	9.00	0.3543	40	84	R5209.0
	9.10	0.3583	40	84	R5209.1
	9.20	0.3622	40	84	R5209.2
	9.30	0.3661	40	84	R5209.3
	9.40	0.3701	40	84	R5209.4
	9.50	0.3740	40	84	R5209.5
3/8	9.52	0.3748	43	89	R5203/8
	9.60	0.3780	43	89	R5209.6
	9.70	0.3819	43	89	R5209.7
	9.80	0.3858	43	89	R5209.8
	9.90	0.3898	43	89	R5209.9
	10.00	0.3937	43	89	R52010.0
	10.10	0.3976	43	89	R52010.1
	10.20	0.4016	43	89	R52010.2
	10.30	0.4055	43	89	R52010.3
	10.40	0.4094	43	89	R52010.4
	10.50	0.4134	43	89	R52010.5
	11.00	0.4331	47	95	R52011.0
7/16	11.11	0.4374	47	95	R5207/16
	11.20	0.4409	47	95	R52011.2
	11.50	0.4528	47	95	R52011.5
	12.00	0.4724	51	102	R52012.0
	12.50	0.4921	51	102	R52012.5
1/2	12.70	0.5000	51	102	R5201/2
	13.00	0.5118	51	102	R52013.0
	13.50	0.5315	54	107	R52013.5
	14.00	0.5512	54	107	R52014.0
	14.20	0.5591	56	111	R52014.2
	14.25	0.5610	56	111	R52014.25
	14.50	0.5709	56	111	R52014.5
	15.00	0.5906	56	111	R52015.0
	15.10	0.5945	58	115	R52015.1
5/8	15.88	0.6252	58	115	R5205/8
	16.00	0.6299	58	115	R52016.0
	16.50	0.6496	60	119	R52016.5

- R510**
- CDX vrták zákl. délka
 - Сверло CDX, короткое исполнение
 - Wiertło typu CDX o standardowej długości
 - CDX vrták základná dĺžka

R510	▪	1.1	1.2	1.3	1.4	1.5	1.6	3.1	3.2	3.3	3.4	7.1	7.2	7.3	7.4	8.1	8.2
	•	1.7	1.8	2.1	4.1	5.1											

R510 **HM** **DIN 338** **4XD** **130°** TiN  **N** 

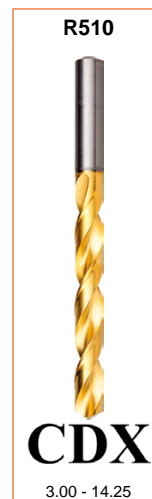
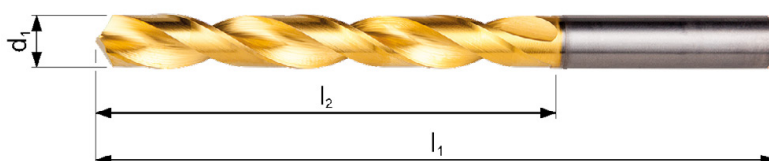

d_1 \varnothing_{h_7} Inch	d_1 \varnothing_{h_7} mm	d_1 decimal Inch	l_2 mm	l_1 mm	R510
1/8	3.00	0.1181	33	61	R5103.0
	3.18	0.1252	36	65	R5101/8
	3.20	0.1260	36	65	R5103.2
	3.30	0.1299	36	65	R5103.3
	3.40	0.1339	39	70	R5103.4
	3.50	0.1378	39	70	R5103.5
	3.70	0.1457	39	70	R5103.7
	3.90	0.1535	43	75	R5103.9
	4.00	0.1575	43	75	R5104.0
	4.10	0.1614	43	75	R5104.1
	4.20	0.1654	43	75	R5104.2
	4.30	0.1693	47	80	R5104.3
	4.50	0.1772	47	80	R5104.5
	4.60	0.1811	47	80	R5104.6
3/16	4.70	0.1850	47	80	R5104.7
	4.76	0.1874	52	86	R5103/16
	4.90	0.1929	52	86	R5104.9
	5.00	0.1969	52	86	R5105.0
	5.10	0.2008	52	86	R5105.1
	5.50	0.2165	57	93	R5105.5
	5.60	0.2205	57	93	R5105.6
	5.70	0.2244	57	93	R5105.7
	6.00	0.2362	57	93	R5106.0
	1/4	6.35	0.2500	63	101
6.50		0.2559	63	101	R5106.5
6.60		0.2598	63	101	R5106.6
6.80		0.2677	69	109	R5106.8
6.90		0.2717	69	109	R5106.9
7.00		0.2756	69	109	R5107.0
7.30		0.2874	69	109	R5107.3
7.40		0.2913	69	109	R5107.4
7.50		0.2953	69	109	R5107.5
7.80		0.3071	75	117	R5107.8
7.90		0.3110	75	117	R5107.9
5/16		7.94	0.3126	75	117
	8.00	0.3150	75	117	R5108.0

d_1 $\varnothing h_7$ Inch	d_1 $\varnothing h_7$ mm	d_1 decimal Inch	l_2 mm	l_1 mm	R510
	8.50	0.3346	75	117	R5108.5
	8.70	0.3425	81	125	R5108.7
	8.80	0.3465	81	125	R5108.8
	9.00	0.3543	81	125	R5109.0
	9.20	0.3622	81	125	R5109.2
	9.30	0.3661	81	125	R5109.3
	9.40	0.3701	81	125	R5109.4
	9.50	0.3740	81	125	R5109.5
3/8	9.52	0.3748	87	133	R5103/8
	9.90	0.3898	87	133	R5109.9
	10.00	0.3937	87	133	R51010.0
	10.20	0.4016	87	133	R51010.2
	10.30	0.4055	87	133	R51010.3
	10.40	0.4094	87	133	R51010.4
	10.50	0.4134	87	133	R51010.5
	10.80	0.4252	94	142	R51010.8
	11.00	0.4331	94	142	R51011.0
7/16	11.11	0.4374	94	142	R5107/16
	11.20	0.4409	94	142	R51011.2
	11.50	0.4528	94	142	R51011.5
	12.00	0.4724	101	151	R51012.0
1/2	12.70	0.5000	101	151	R5101/2
	13.00	0.5118	101	151	R51013.0
	14.00	0.5512	108	160	R51014.0
	14.25	0.5610	114	169	R51014.25

R458

- Force-X vrták, délka 3XD
- Force-X Короткое сверло 3XD
- Wiertło typu Force-X krótkie 3XD
- Force-X vrták krátky 3XD

R457

- Force-X vrták s vnitřním chlazením, délka 3XD
- Force-X Короткое сверло с подводом СОЖ 3XD
- Wiertło typu Force-X z chlazením wew. 3XD
- Force-X vrták s vnútorným chladením, 3XD

R458	▪	1.1	1.2	1.3	1.4	1.5	1.6	1.7	1.8	2.1	2.2	2.3	3.1	3.2	3.3	3.4	6.1	6.2	6.3	7.1	7.2
		7.3	7.4																		
	•	2.4	4.1	4.2	4.3	6.4															
R457	▪	1.1	1.2	1.3	1.4	1.5	1.6	1.7	1.8	2.1	2.2	2.3	3.1	3.2	3.3	3.4	4.1	4.2	4.3	6.1	6.2
		6.3	6.4	7.1	7.2	7.3	7.4														

R458	HM	DIN 6537 K	3XD	140°	TiAlN	DIN 6535HA	CTW			
R457	HM	DIN 6537 K	3XD	140°	TiAlN	DIN 6535HA	CTW			

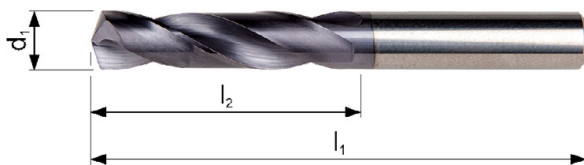

d_1 Ø "/Nr.	d_1 Ø _{m7} mm	d_1 decimal Inch	l_2 mm	l_1 mm	l_3 mm	d_2 Ø _{h6} mm	R458	R457
	3.00	0.1181	20	62	36	6	R4583.0	R4573.0
	3.10	0.1220	20	62	36	6	R4583.1	R4573.1
1/8	3.18	0.1252	20	62	36	6	R4581/8	R4571/8
	3.20	0.1260	20	62	36	6	R4583.2	R4573.2
30	3.26	0.1283	20	62	36	6	R458N30	R457N30
	3.30	0.1299	20	62	36	6	R4583.3	R4573.3
	3.40	0.1339	20	62	36	6	R4583.4	R4573.4
29	3.45	0.1358	20	62	36	6	R458N29	R457N29
	3.50	0.1378	20	62	36	6	R4583.5	R4573.5
28	3.57	0.1406	20	62	36	6	R458N28	R457N28
9/64	3.57	0.1406	20	62	36	6	R4589/64	R4579/64
	3.60	0.1417	20	62	36	6	R4583.6	R4573.6
27	3.66	0.1441	20	62	36	6	R458N27	R457N27
	3.70	0.1457	20	62	36	6	R4583.7	R4573.7
	3.73	0.1469	24	66	36	6	R4583.73	
26	3.73	0.1469	24	66	36	6	R458N26	R457N26
	3.80	0.1496	24	66	36	6	R4583.8	R4573.8
25	3.80	0.1496	24	66	36	6	R458N25	R457N25
24	3.86	0.1520	24	66	36	6	R458N24	R457N24
	3.90	0.1535	24	66	36	6	R4583.9	R4573.9
23	3.91	0.1539	24	66	36	6	R458N23	R457N23
5/32	3.97	0.1563	24	66	36	6	R4585/32	R4575/32
22	3.99	0.1571	24	66	36	6	R458N22	R457N22
	4.00	0.1575	24	66	36	6	R4584.0	R4574.0

d ₁ Ø "/Nr.	d ₁ Øm ₇ mm	d ₁ decimal Inch	l ₂ mm	l ₁ mm	l ₃ mm	d ₂ Øh ₆ mm	R458	R457
21	4.04	0.1591	24	66	36	6	R458N21	R457N21
	4.05	0.1594	24	66	36	6		R4574.05
20	4.09	0.1610	24	66	36	6	R458N20	R457N20
	4.10	0.1614	24	66	36	6	R4584.1	R4574.1
	4.20	0.1654	24	66	36	6	R4584.2	R4574.2
19	4.22	0.1661	24	66	36	6	R458N19	R457N19
	4.30	0.1693	24	66	36	6	R4584.3	R4574.3
18	4.31	0.1697	24	66	36	6	R458N18	R457N18
11/64	4.37	0.1720	24	66	36	6	R45811/64	R45711/64
17	4.39	0.1728	24	66	36	6	R458N17	R457N17
	4.40	0.1732	24	66	36	6	R4584.4	R4574.4
16	4.50	0.1772	24	66	36	6	R458N16	R457N16
	4.50	0.1772	24	66	36	6	R4584.5	R4574.5
15	4.57	0.1799	24	66	36	6	R458N15	R457N15
	4.60	0.1811	24	66	36	6	R4584.6	R4574.6
14	4.62	0.1819	24	66	36	6	R458N14	R457N14
	4.70	0.1850	24	66	36	6	R4584.7	R4574.7
13	4.70	0.1850	24	66	36	6	R458N13	R457N13
3/16	4.76	0.1874	28	66	36	6	R4583/16	R4573/16
	4.80	0.1890	28	66	36	6	R4584.8	R4574.8
12	4.80	0.1890	28	66	36	6	R458N12	R457N12
11	4.85	0.1909	28	66	36	6	R458N11	R457N11
	4.90	0.1929	28	66	36	6	R4584.9	R4574.9
10	4.92	0.1937	28	66	36	6	R458N10	R457N10
9	4.98	0.1961	28	66	36	6	R458N9	R457N9
	5.00	0.1969	28	66	36	6	R4585.0	R4575.0
	5.05	0.1988	28	66	36	6		R4575.05
8	5.06	0.1992	28	66	36	6	R458N8	R457N8
	5.10	0.2008	28	66	36	6	R4585.1	R4575.1
7	5.11	0.2012	28	66	36	6	R458N7	R457N7
13/64	5.16	0.2031	28	66	36	6	R45813/64	R45713/64
6	5.18	0.2039	28	66	36	6	R458N6	R457N6
	5.20	0.2047	28	66	36	6	R4585.2	R4575.2
5	5.22	0.2055	28	66	36	6	R458N5	R457N5
	5.30	0.2087	28	66	36	6	R4585.3	R4575.3
4	5.31	0.2091	28	66	36	6	R458N4	R457N4
	5.40	0.2126	28	66	36	6	R4585.4	R4575.4
3	5.41	0.2130	28	66	36	6	R458N3	R457N3
	5.50	0.2165	28	66	36	6	R4585.5	R4575.5
7/32	5.56	0.2189	28	66	36	6	R4587/32	R4577/32
	5.60	0.2205	28	66	36	6	R4585.6	R4575.6
2	5.61	0.2209	28	66	36	6	R458N2	R457N2
	5.70	0.2244	28	66	36	6	R4585.7	R4575.7
1	5.79	0.2280	28	66	36	6	R458N1	R457N1
	5.80	0.2283	28	66	36	6	R4585.8	R4575.8
	5.90	0.2323	28	66	36	6	R4585.9	R4575.9
A	5.94	0.2339	28	66	36	6	R458A	R457A
15/64	5.95	0.2343	28	66	36	6	R45815/64	R45715/64
	6.00	0.2362	28	66	36	6	R4586.0	R4576.0
B	6.03	0.2374	34	79	36	8	R458B	R457B
	6.05	0.2382	34	79	36	8		R4576.05
	6.10	0.2402	34	79	36	8	R4586.1	R4576.1
C	6.15	0.2421	34	79	36	8	R458C	R457C
	6.20	0.2441	34	79	36	8	R4586.2	R4576.2
D	6.25	0.2461	34	79	36	8	R458D	R457D
	6.30	0.2480	34	79	36	8	R4586.3	R4576.3
1/4	6.35	0.2500	34	79	36	8	R4581/4	R4571/4
E	6.35	0.2500	34	79	36	8	R458E	R457E
	6.40	0.2520	34	79	36	8	R4586.4	R4576.4
	6.50	0.2559	34	79	36	8	R4586.5	R4576.5
F	6.53	0.2571	34	79	36	8	R458F	R457F
	6.60	0.2598	34	79	36	8	R4586.6	R4576.6
G	6.63	0.2610	34	79	36	8	R458G	R457G
	6.70	0.2638	34	79	36	8	R4586.7	R4576.7
17/64	6.75	0.2657	34	79	36	8	R45817/64	R45717/64
H	6.76	0.2661	34	79	36	8	R458H	R457H
	6.80	0.2677	34	79	36	8	R4586.8	R4576.8
	6.90	0.2717	34	79	36	8	R4586.9	R4576.9
I	6.91	0.2720	34	79	36	8	R458I	R457I
	7.00	0.2756	34	79	36	8	R4587.0	R4577.0

d ₁ Ø "/Nr.	d ₁ Øm ₇ mm	d ₁ decimal Inch	l ₂ mm	l ₁ mm	l ₃ mm	d ₂ Øh ₅ mm	R458	R457
J	7.04	0.2772	41	79	36	8	R458J	R457J
	7.10	0.2795	41	79	36	8	R4587.1	R4577.1
K	7.14	0.2811	41	79	36	8	R458K	R457K
9/32	7.14	0.2811	41	79	36	8	R4589/32	R4579/32
	7.20	0.2835	41	79	36	8	R4587.2	R4577.2
	7.30	0.2874	41	79	36	8	R4587.3	R4577.3
L	7.37	0.2902	41	79	36	8	R458L	R457L
	7.40	0.2913	41	79	36	8	R4587.4	R4577.4
M	7.49	0.2949	41	79	36	8	R458M	R457M
	7.50	0.2953	41	79	36	8	R4587.5	R4577.5
19/64	7.54	0.2969	41	79	36	8	R45819/64	R45719/64
	7.60	0.2992	41	79	36	8	R4587.6	R4577.6
N	7.67	0.3020	41	79	36	8	R458N	R457N
	7.70	0.3031	41	79	36	8	R4587.7	R4577.7
	7.80	0.3071	41	79	36	8	R4587.8	R4577.8
	7.90	0.3110	41	79	36	8	R4587.9	R4577.9
5/16	7.94	0.3126	41	79	36	8	R4585/16	R4575/16
	8.00	0.3150	41	79	36	8	R4588.0	R4578.0
O	8.03	0.3161	47	89	40	10	R458O	R457O
	8.05	0.3169	47	89	40	10		R4578.05
	8.10	0.3189	47	89	40	10	R4588.1	R4578.1
	8.20	0.3228	47	89	40	10	R4588.2	R4578.2
P	8.20	0.3228	47	89	40	10	R458P	R457P
	8.30	0.3268	47	89	40	10	R4588.3	R4578.3
21/64	8.33	0.3280	47	89	40	10	R45821/64	R45721/64
	8.40	0.3307	47	89	40	10	R4588.4	R4578.4
Q	8.43	0.3319	47	89	40	10	R458Q	R457Q
	8.50	0.3346	47	89	40	10	R4588.5	R4578.5
	8.60	0.3386	47	89	40	10	R4588.6	R4578.6
R	8.61	0.3390	47	89	40	10	R458R	R457R
	8.70	0.3425	47	89	40	10	R4588.7	R4578.7
11/32	8.73	0.3437	47	89	40	10	R45811/32	R45711/32
	8.80	0.3465	47	89	40	10	R4588.8	R4578.8
S	8.84	0.3480	47	89	40	10	R458S	R457S
	8.90	0.3504	47	89	40	10	R4588.9	R4578.9
	9.00	0.3543	47	89	40	10	R4589.0	R4579.0
T	9.09	0.3579	47	89	40	10	R458T	R457T
	9.10	0.3583	47	89	40	10	R4589.1	R4579.1
23/64	9.13	0.3594	47	89	40	10	R45823/64	R45723/64
	9.20	0.3622	47	89	40	10	R4589.2	R4579.2
	9.30	0.3661	47	89	40	10	R4589.3	R4579.3
U	9.35	0.3681	47	89	40	10	R458U	R457U
	9.40	0.3701	47	89	40	10	R4589.4	R4579.4
	9.50	0.3740	47	89	40	10	R4589.5	R4579.5
3/8	9.52	0.3748	47	89	40	10	R4583/8	R4573/8
V	9.58	0.3772	47	89	40	10	R458V	R457V
	9.60	0.3780	47	89	40	10	R4589.6	R4579.6
	9.70	0.3819	47	89	40	10	R4589.7	R4579.7
	9.80	0.3858	47	89	40	10	R4589.8	R4579.8
W	9.80	0.3858	47	89	40	10	R458W	R457W
	9.90	0.3898	47	89	40	10	R4589.9	R4579.9
25/64	9.92	0.3906	47	89	40	10	R45825/64	R45725/64
	10.00	0.3937	47	89	40	10	R45810.0	R45710.0
	10.05	0.3957	55	102	45	12		R45710.05
X	10.08	0.3969	55	102	45	12	R458X	R457X
	10.10	0.3976	55	102	45	12	R45810.1	R45710.1
	10.20	0.4016	55	102	45	12	R45810.2	R45710.2
Y	10.26	0.4039	55	102	45	12	R458Y	R457Y
	10.30	0.4055	55	102	45	12	R45810.3	R45710.3
13/32	10.32	0.4063	55	102	45	12	R45813/32	R45713/32
	10.40	0.4094	55	102	45	12	R45810.4	R45710.4
Z	10.49	0.4130	55	102	45	12	R458Z	R457Z
	10.50	0.4134	55	102	45	12	R45810.5	R45710.5
	10.60	0.4173	55	102	45	12	R45810.6	R45710.6
	10.70	0.4213	55	102	45	12	R45810.7	
27/64	10.72	0.4220	55	102	45	12	R45827/64	R45727/64
	10.80	0.4252	55	102	45	12	R45810.8	R45710.8
	10.90	0.4291	55	102	45	12	R45810.9	
	11.00	0.4331	55	102	45	12	R45811.0	R45711.0
	11.10	0.4370	55	102	45	12	R45811.1	

d_1 Ø "/Nr.	d_1 Ø _{m7} mm	d_1 decimal Inch	l_2 mm	l_1 mm	l_3 mm	d_2 Ø _{h6} mm	R458	R457
7/16	11.11	0.4374	55	102	45	12	R4587/16	R4577/16
	11.20	0.4409	55	102	45	12	R45811.2	R45711.2
	11.30	0.4449	55	102	45	12	R45811.3	R45711.3
	11.40	0.4488	55	102	45	12	R45811.4	R45711.4
29/64	11.50	0.4528	55	102	45	12	R45811.5	R45711.5
	11.51	0.4531	55	102	45	12	R45829/64	R45729/64
	11.60	0.4567	55	102	45	12	R45811.6	R45711.6
	11.70	0.4606	55	102	45	12	R45811.7	
	11.80	0.4646	55	102	45	12	R45811.8	R45711.8
15/32	11.90	0.4685	55	102	45	12	R45811.9	
	11.91	0.4689	55	102	45	12	R45815/32	R45715/32
	12.00	0.4724	55	102	45	12	R45812.0	R45712.0
	12.05	0.4744	60	107	45	14		R45712.05
31/64	12.10	0.4764	60	107	45	14	R45812.1	R45712.1
	12.20	0.4803	60	107	45	14	R45812.2	R45712.2
	12.30	0.4843	60	107	45	14	R45831/64	R45731/64
	12.50	0.4921	60	107	45	14	R45812.5	R45712.5
1/2	12.70	0.5000	60	107	45	14	R45812.7	R45712.7
	12.70	0.5000	60	107	45	14	R4581/2	R4571/2
	12.80	0.5039	60	107	45	14	R45812.8	R45712.8
33/64	13.00	0.5118	60	107	45	14	R45813.0	R45713.0
	13.10	0.5157	60	107	45	14	R45833/64	R45733/64
	13.30	0.5236	60	107	45	14	R45813.3	R45713.3
17/32	13.49	0.5311	60	107	45	14	R45817/32	R45717/32
	13.50	0.5315	60	107	45	14	R45813.5	R45713.5
35/64	13.80	0.5433	60	107	45	14	R45813.8	R45713.8
	13.89	0.5469	60	107	45	14	R45835/64	R45735/64
	14.00	0.5512	60	107	45	14	R45814.0	R45714.0
	14.25	0.5610	65	115	48	16	R45814.25	R45714.25
9/16	14.29	0.5626	65	115	48	16	R4589/16	R4579/16
	14.50	0.5709	65	115	48	16	R45814.5	R45714.5
37/64	14.68	0.5780	65	115	48	16	R45837/64	R45737/64
	14.80	0.5827	65	115	48	16	R45814.8	R45714.8
	15.00	0.5906	65	115	48	16	R45815.0	R45715.0
19/32	15.08	0.5937	65	115	48	16	R45819/32	R45719/32
	15.10	0.5945	65	115	48	16	R45815.1	R45715.1
	15.30	0.6024	65	115	48	16	R45815.3	R45715.3
39/64	15.48	0.6094	65	115	48	16	R45839/64	R45739/64
	15.50	0.6102	65	115	48	16	R45815.5	R45715.5
	15.80	0.6220	65	115	48	16	R45815.8	R45715.8
5/8	15.88	0.6252	65	115	48	16	R4585/8	R4575/8
	16.00	0.6299	65	115	48	16	R45816.0	R45716.0
41/64	16.27	0.6406	73	123	48	18	R45841/64	R45741/64
	16.50	0.6496	73	123	48	18	R45816.5	R45716.5
21/32	16.67	0.6563	73	123	48	18	R45821/32	R45721/32
	17.00	0.6693	73	123	48	18	R45817.0	R45717.0
43/64	17.07	0.6720	73	123	48	18	R45843/64	R45743/64
11/16	17.46	0.6874	73	123	48	18	R45811/16	R45711/16
	17.50	0.6890	73	123	48	18	R45817.5	R45717.5
	17.80	0.7008	73	123	48	18	R45817.8	
45/64	17.86	0.7031	73	123	48	18	R45845/64	R45745/64
	18.00	0.7087	73	123	48	18	R45818.0	R45718.0
	18.26	0.7189	79	131	50	20	R45823/32	R45723/32
23/32	18.50	0.7283	79	131	50	20	R45818.5	R45718.5
	18.65	0.7343	79	131	50	20	R45847/64	R45747/64
47/64	18.80	0.7402	79	131	50	20		R45718.8
	19.00	0.7480	79	131	50	20	R45819.0	R45719.0
	19.05	0.7500	79	131	50	20	R4583/4	R4573/4
	19.50	0.7677	79	131	50	20	R45819.5	R45719.5
3/4	19.80	0.7795	79	131	50	20	R45819.8	R45719.8
	20.00	0.7874	79	131	50	20	R45820.0	R45720.0

R454

- Force-X vrták, délka 5XD
- Force-X Длинное сверло 5XD
- Wiertło typu Force-X długie 5XD
- Force-X vrták dlhý 5XD

R453

- Force-X vrták s vnitřním chlazením, délka 5XD
- Force-X Длинное сверло с подводом СОЖ 5XD
- Wiertło typu Force-X z chłodzeniem wew. 5XD
- Force-X vrták s vnútorným chladením, 5XD

R454	▪	1.1	1.2	1.3	1.4	1.5	1.6	1.7	1.8	2.1	2.2	2.3	3.1	3.2	3.3	3.4	6.1	6.2	6.3	7.1	7.2
		7.3	7.4																		
	•	2.4	4.1	4.2	4.3	6.4															
R453	▪	1.1	1.2	1.3	1.4	1.5	1.6	1.7	1.8	2.1	2.2	3.1	3.2	3.3	3.4	4.1	4.2	4.3	6.1	6.2	6.3
		6.4	7.1	7.2	7.3	7.4															
	•	2.3	2.4																		

R454	HM	DIN 6537 L	5XD	140°	TiAIN	DIN 6535HA	GTW™			
R453	HM	DIN 6537 L	5XD	140°	TiAIN	DIN 6535HA	GTW™			

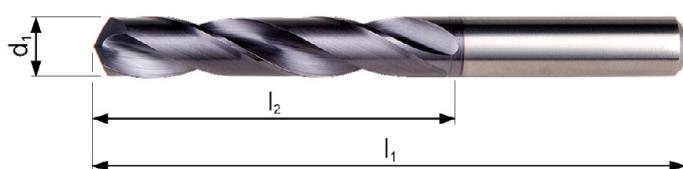

d_1 Ø Inch	d_1 Ø _{m7} mm	d_1 decimal Inch	l_2 mm	l_1 mm	l_3 mm	d_2 Ø _{h6} mm	R454	R453
	3.00	0.1181	28	66	36	6	R4543.0	R4533.0
	3.10	0.1220	28	66	36	6	R4543.1	R4533.1
1/8	3.18	0.1252	28	66	36	6	R4541/8	R4531/8
	3.20	0.1260	28	66	36	6	R4543.2	R4533.2
30	3.26	0.1283	28	66	36	6	R454N30	R453N30
	3.30	0.1299	28	66	36	6	R4543.3	R4533.3
	3.40	0.1339	28	66	36	6	R4543.4	R4533.4
29	3.45	0.1358	28	66	36	6	R454N29	R453N29
	3.50	0.1378	28	66	36	6	R4543.5	R4533.5
28	3.57	0.1406	28	66	36	6	R454N28	R453N28
9/64	3.57	0.1406	28	66	36	6	R4549/64	R4539/64
	3.60	0.1417	28	66	36	6	R4543.6	R4533.6
27	3.66	0.1441	28	66	36	6	R454N27	R453N27
	3.70	0.1457	28	66	36	6	R4543.7	R4533.7
26	3.73	0.1469	36	74	36	6	R454N26	R453N26
	3.80	0.1496	36	74	36	6	R4543.8	R4533.8
25	3.80	0.1496	36	74	36	6	R454N25	R453N25
24	3.86	0.1520	36	74	36	6	R454N24	R453N24
	3.90	0.1535	36	74	36	6	R4543.9	R4533.9
23	3.91	0.1539	36	74	36	6	R454N23	R453N23
5/32	3.97	0.1563	36	74	36	6	R4545/32	R4535/32
22	3.99	0.1571	36	74	36	6	R454N22	R453N22

d ₁ Ø Inch	d ₁ Øm ₇ mm	d ₁ decimal Inch	l ₂ mm	l ₁ mm	l ₃ mm	d ₂ Øh ₆ mm	R454	R453
	4.00	0.1575	36	74	36	6	R4544.0	R4534.0
21	4.04	0.1591	36	74	36	6	R454N21	R453N21
	4.05	0.1594	36	74	36	6		R4534.05
20	4.09	0.1610	36	74	36	6	R454N20	R453N20
	4.10	0.1614	36	74	36	6	R4544.1	R4534.1
	4.20	0.1654	36	74	36	6	R4544.2	R4534.2
19	4.22	0.1661	36	74	36	6	R454N19	R453N19
	4.30	0.1693	36	74	36	6	R4544.3	R4534.3
18	4.31	0.1697	36	74	36	6	R454N18	R453N18
11/64	4.37	0.1720	36	74	36	6	R45411/64	R45311/64
17	4.39	0.1728	36	74	36	6	R454N17	R453N17
	4.40	0.1732	36	74	36	6	R4544.4	R4534.4
	4.50	0.1772	36	74	36	6	R4544.5	R4534.5
16	4.50	0.1772	36	74	36	6	R454N16	R453N16
15	4.57	0.1799	36	74	36	6	R454N15	R453N15
	4.60	0.1811	36	74	36	6	R4544.6	R4534.6
14	4.62	0.1819	36	74	36	6	R454N14	R453N14
	4.70	0.1850	36	74	36	6	R4544.7	R4534.7
13	4.70	0.1850	36	74	36	6	R454N13	R453N13
3/16	4.76	0.1874	44	82	36	6	R4543/16	R4533/16
	4.80	0.1890	44	82	36	6	R4544.8	R4534.8
12	4.80	0.1890	44	82	36	6	R454N12	R453N12
11	4.85	0.1909	44	82	36	6	R454N11	R453N11
	4.90	0.1929	44	82	36	6	R4544.9	R4534.9
10	4.92	0.1937	44	82	36	6	R454N10	R453N10
9	4.98	0.1961	44	82	36	6	R454N9	R453N9
	5.00	0.1969	44	82	36	6	R4545.0	R4535.0
	5.05	0.1988	44	82	36	6		R4535.05
8	5.06	0.1992	44	82	36	6	R454N8	R453N8
	5.10	0.2008	44	82	36	6	R4545.1	R4535.1
7	5.11	0.2012	44	82	36	6	R454N7	R453N7
13/64	5.16	0.2031	44	82	36	6	R45413/64	R45313/64
6	5.18	0.2039	44	82	36	6	R454N6	R453N6
	5.20	0.2047	44	82	36	6	R4545.2	R4535.2
5	5.22	0.2055	44	82	36	6	R454N5	R453N5
	5.30	0.2087	44	82	36	6		R4535.3
4	5.31	0.2091	44	82	36	6	R454N4	R453N4
	5.40	0.2126	44	82	36	6		R4535.4
3	5.41	0.2130	44	82	36	6	R454N3	R453N3
	5.50	0.2165	44	82	36	6	R4545.5	R4535.5
7/32	5.56	0.2189	44	82	36	6	R4547/32	R4537/32
	5.60	0.2205	44	82	36	6	R4545.6	R4535.6
2	5.61	0.2209	44	82	36	6	R454N2	R453N2
	5.70	0.2244	44	82	36	6	R4545.7	R4535.7
1	5.79	0.2280	44	82	36	6	R454N1	R453N1
	5.80	0.2283	44	82	36	6	R4545.8	R4535.8
	5.90	0.2323	44	82	36	6	R4545.9	R4535.9
A	5.94	0.2339	44	82	36	6	R454A	R453A
15/64	5.95	0.2343	44	82	36	6	R45415/64	R45315/64
	6.00	0.2362	44	82	36	6	R4546.0	R4536.0
B	6.03	0.2374	53	91	36	8	R454B	R453B
	6.05	0.2382	53	91	36	8		R4536.05
	6.10	0.2402	53	91	36	8	R4546.1	R4536.1
C	6.15	0.2421	53	91	36	8	R454C	R453C
	6.20	0.2441	53	91	36	8	R4546.2	R4536.2
D	6.25	0.2461	53	91	36	8	R454D	R453D
	6.30	0.2480	53	91	36	8	R4546.3	R4536.3
1/4	6.35	0.2500	53	91	36	8	R4541/4	R4531/4
E	6.35	0.2500	53	91	36	8	R454E	R453E
	6.40	0.2520	53	91	36	8	R4546.4	R4536.4
	6.50	0.2559	53	91	36	8	R4546.5	R4536.5
F	6.53	0.2571	53	91	36	8	R454F	R453F
	6.60	0.2598	53	91	36	8	R4546.6	R4536.6
G	6.63	0.2610	53	91	36	8	R454G	R453G
	6.70	0.2638	53	91	36	8	R4546.7	R4536.7
17/64	6.75	0.2657	53	91	36	8	R45417/64	R45317/64
H	6.76	0.2661	53	91	36	8	R454H	R453H
	6.80	0.2677	53	91	36	8	R4546.8	R4536.8
	6.90	0.2717	53	91	36	8	R4546.9	R4536.9

d_1 Ø Inch	d_1 Ø m_7 mm	d_1 decimal Inch	l_2 mm	l_1 mm	l_3 mm	d_2 Ø h_5 mm	R454	R453
I	6.91	0.2720	53	91	36	8	R454I	R453I
	7.00	0.2756	53	91	36	8	R4547.0	R4537.0
J	7.04	0.2772	53	91	36	8	R454J	R453J
	7.10	0.2795	53	91	36	8	R4547.1	R4537.1
K	7.14	0.2811	53	91	36	8	R454K	R453K
9/32	7.14	0.2811	53	91	36	8	R4549/32	R4539/32
	7.20	0.2835	53	91	36	8		R4537.2
	7.30	0.2874	53	91	36	8	R4547.3	R4537.3
L	7.37	0.2902	53	91	36	8	R454L	R453L
	7.40	0.2913	53	91	36	8	R4547.4	R4537.4
M	7.49	0.2949	53	91	36	8	R454M	R453M
	7.50	0.2953	53	91	36	8	R4547.5	R4537.5
19/64	7.54	0.2969	53	91	36	8	R45419/64	R45319/64
	7.60	0.2992	53	91	36	8	R4547.6	R4537.6
N	7.67	0.3020	53	91	36	8	R454N	R453N
	7.70	0.3031	53	91	36	8	R4547.7	R4537.7
	7.80	0.3071	53	91	36	8	R4547.8	R4537.8
	7.90	0.3110	53	91	36	8	R4547.9	R4537.9
5/16	7.94	0.3126	53	91	36	8	R4545/16	R4535/16
	8.00	0.3150	53	91	36	8	R4548.0	R4538.0
O	8.03	0.3161	61	103	40	10	R454O	R453O
	8.05	0.3169	61	103	40	10		R4538.05
	8.10	0.3189	61	103	40	10	R4548.1	R4538.1
	8.20	0.3228	61	103	40	10	R4548.2	R4538.2
P	8.20	0.3228	61	103	40	10	R454P	R453P
	8.30	0.3268	61	103	40	10		R4538.3
21/64	8.33	0.3280	61	103	40	10	R45421/64	R45321/64
	8.40	0.3307	61	103	40	10	R4548.4	R4538.4
Q	8.43	0.3319	61	103	40	10	R454Q	R453Q
	8.50	0.3346	61	103	40	10	R4548.5	R4538.5
	8.60	0.3386	61	103	40	10	R4548.6	R4538.6
R	8.61	0.3390	61	103	40	10	R454R	R453R
	8.70	0.3425	61	103	40	10	R4548.7	R4538.7
11/32	8.73	0.3437	61	103	40	10	R45411/32	R45311/32
	8.80	0.3465	61	103	40	10	R4548.8	R4538.8
S	8.84	0.3480	61	103	40	10	R454S	R453S
	8.90	0.3504	61	103	40	10	R4548.9	R4538.9
	9.00	0.3543	61	103	40	10	R4549.0	R4539.0
T	9.09	0.3579	61	103	40	10	R454T	R453T
	9.10	0.3583	61	103	40	10	R4549.1	R4539.1
23/64	9.13	0.3594	61	103	40	10	R45423/64	R45323/64
	9.20	0.3622	61	103	40	10		R4539.2
	9.30	0.3661	61	103	40	10	R4549.3	R4539.3
U	9.35	0.3681	61	103	40	10	R454U	R453U
	9.40	0.3701	61	103	40	10	R4549.4	R4539.4
	9.50	0.3740	61	103	40	10	R4549.5	R4539.5
3/8	9.52	0.3748	61	103	40	10	R4543/8	R4533/8
V	9.58	0.3772	61	103	40	10	R454V	R453V
	9.60	0.3780	61	103	40	10	R4549.6	R4539.6
	9.70	0.3819	61	103	40	10	R4549.7	R4539.7
	9.80	0.3858	61	103	40	10	R4549.8	R4539.8
W	9.80	0.3858	61	103	40	10	R454W	R453W
	9.90	0.3898	61	103	40	10	R4549.9	R4539.9
25/64	9.92	0.3906	61	103	40	10	R45425/64	R45325/64
	10.00	0.3937	61	103	40	10	R45410.0	R45310.0
	10.05	0.3957	70	118	45	12		R45310.05
X	10.08	0.3969	70	118	45	12	R454X	R453X
	10.10	0.3976	70	118	45	12	R45410.1	R45310.1
	10.20	0.4016	70	118	45	12	R45410.2	R45310.2
Y	10.26	0.4039	70	118	45	12	R454Y	R453Y
	10.30	0.4055	70	118	45	12	R45410.3	R45310.3
13/32	10.32	0.4063	70	118	45	12	R45413/32	R45313/32
	10.40	0.4094	70	118	45	12	R45410.4	R45310.4
Z	10.49	0.4130	70	118	45	12	R454Z	R453Z
	10.50	0.4134	70	118	45	12	R45410.5	R45310.5
	10.60	0.4173	70	118	45	12	R45410.6	R45310.6
27/64	10.72	0.4220	70	118	45	12	R45427/64	R45327/64
	10.80	0.4252	70	118	45	12		R45310.8
	11.00	0.4331	70	118	45	12	R45411.0	R45311.0
7/16	11.11	0.4374	70	118	45	12	R4547/16	R4537/16

d ₁ Ø Inch	d ₁ Øm ₇ mm	d ₁ decimal Inch	l ₂ mm	l ₁ mm	l ₃ mm	d ₂ Øh ₆ mm	R454	R453
	11.20	0.4409	70	118	45	12	R45411.2	R45311.2
	11.30	0.4449	70	118	45	12		R45311.3
	11.40	0.4488	70	118	45	12	R45411.4	R45311.4
	11.50	0.4528	70	118	45	12	R45411.5	R45311.5
29/64	11.51	0.4531	70	118	45	12	R45429/64	R45329/64
	11.60	0.4567	70	118	45	12	R45411.6	R45311.6
	11.80	0.4646	70	118	45	12	R45411.8	R45311.8
15/32	11.91	0.4689	70	118	45	12	R45415/32	R45315/32
	12.00	0.4724	70	118	45	12	R45412.0	R45312.0
	12.05	0.4744	76	124	45	14		R45312.05
	12.10	0.4764	76	124	45	14	R45412.1	
	12.20	0.4803	76	124	45	14	R45412.2	R45312.2
31/64	12.30	0.4843	76	124	45	14	R45431/64	R45331/64
	12.50	0.4921	76	124	45	14	R45412.5	R45312.5
	12.70	0.5000	76	124	45	14	R45412.7	R45312.7
1/2	12.70	0.5000	76	124	45	14	R4541/2	R4531/2
	12.80	0.5039	76	124	45	14	R45412.8	R45312.8
	13.00	0.5118	76	124	45	14	R45413.0	R45313.0
33/64	13.10	0.5157	76	124	45	14	R45433/64	R45333/64
	13.30	0.5236	76	124	45	14		R45313.3
17/32	13.49	0.5311	76	124	45	14	R45417/32	R45317/32
	13.50	0.5315	76	124	45	14	R45413.5	R45313.5
	13.80	0.5433	76	124	45	14	R45413.8	R45313.8
35/64	13.89	0.5469	76	124	45	14	R45435/64	R45335/64
	14.00	0.5512	76	124	45	14	R45414.0	R45314.0
	14.25	0.5610	82	133	48	16	R45414.25	R45314.25
9/16	14.29	0.5626	82	133	48	16	R4549/16	R4539/16
	14.50	0.5709	82	133	48	16	R45414.5	R45314.5
37/64	14.68	0.5780	82	133	48	16	R45437/64	R45337/64
	14.80	0.5827	82	133	48	16	R45414.8	R45314.8
	15.00	0.5906	82	133	48	16	R45415.0	R45315.0
19/32	15.08	0.5937	82	133	48	16	R45419/32	R45319/32
	15.10	0.5945	82	133	48	16	R45415.1	R45315.1
	15.30	0.6024	82	133	48	16		R45315.3
39/64	15.48	0.6094	82	133	48	16	R45439/64	R45339/64
	15.50	0.6102	82	133	48	16	R45415.5	R45315.5
	15.80	0.6220	82	133	48	16	R45415.8	R45315.8
5/8	15.88	0.6252	82	133	48	16	R4545/8	R4535/8
	16.00	0.6299	82	133	48	16	R45416.0	R45316.0
41/64	16.27	0.6406	91	143	48	18	R45441/64	R45341/64
	16.50	0.6496	91	143	48	18	R45416.5	R45316.5
21/32	16.67	0.6563	91	143	48	18	R45421/32	R45321/32
	17.00	0.6693	91	143	48	18	R45417.0	R45317.0
43/64	17.07	0.6720	91	143	48	18	R45443/64	R45343/64
11/16	17.46	0.6874	91	143	48	18	R45411/16	R45311/16
	17.50	0.6890	91	143	48	18	R45417.5	R45317.5
	17.80	0.7008	91	143	48	18	R45417.8	R45317.8
45/64	17.86	0.7031	91	143	48	18	R45445/64	R45345/64
	18.00	0.7087	91	143	48	18	R45418.0	R45318.0
23/32	18.26	0.7189	99	153	50	20	R45423/32	R45323/32
	18.50	0.7283	99	153	50	20	R45418.5	R45318.5
47/64	18.65	0.7343	99	153	50	20	R45447/64	R45347/64
	19.00	0.7480	99	153	50	20	R45419.0	R45319.0
3/4	19.05	0.7500	99	153	50	20	R4543/4	R4533/4
	19.50	0.7677	99	153	50	20	R45419.5	R45319.5
	19.80	0.7795	99	153	50	20	R45419.8	R45319.8
	20.00	0.7874	99	153	50	20	R45420.0	R45320.0

R459

- Force-X vrták s vnitřním chlazením, délka 8XD
- Force-X Длинное сверло с подводом СОЖ 8XD
- Wiertło typu Force-X z chłodzeniem wew. 8XD
- Force-X vrták s vnútorným chladením, 8XD

R459	▪	1.1	1.2	1.3	1.4	1.5	1.6	2.1	2.2	3.1	3.2	3.3	3.4	7.2	7.3
	•	2.3	6.1	6.2	6.3	6.4	7.1								

R459

HM

DORMER

8XD

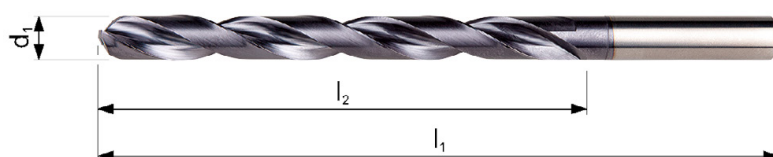

R459



FORCE X

3.00 - 16.00

d_1 \varnothing_{m_7} Inch	d_1 \varnothing_{m_7} mm	d_1 decimal Inch	l_2 mm	l_1 mm	l_3 mm	d_2 \varnothing_{h_6} mm	R459
	3.00	0.1181	37	79	36	6	R4593.0
	3.10	0.1220	37	79	36	6	R4593.1
1/8	3.18	0.1252	37	79	36	6	R4591/8
	3.20	0.1260	37	79	36	6	R4593.2
	3.30	0.1299	37	79	36	6	R4593.3
	3.40	0.1339	37	79	36	6	R4593.4
	3.50	0.1378	37	79	36	6	R4593.5
9/64	3.57	0.1406	37	79	36	6	R4599/64
	3.60	0.1417	37	79	36	6	R4593.6
	3.70	0.1457	37	79	36	6	R4593.7
	3.80	0.1496	48	90	36	6	R4593.8
	3.90	0.1535	48	90	36	6	R4593.9
5/32	3.97	0.1563	48	90	36	6	R4595/32
	4.00	0.1575	48	90	36	6	R4594.0
	4.10	0.1614	48	90	36	6	R4594.1
	4.20	0.1654	48	90	36	6	R4594.2
	4.30	0.1693	48	90	36	6	R4594.3
11/64	4.37	0.1720	48	90	36	6	R45911/64
	4.40	0.1732	48	90	36	6	R4594.4
	4.50	0.1772	48	90	36	6	R4594.5
	4.60	0.1811	48	90	36	6	R4594.6
	4.70	0.1850	62	104	36	6	R4594.7
3/16	4.76	0.1874	62	104	36	6	R4593/16
	4.80	0.1890	62	104	36	6	R4594.8
	4.90	0.1929	62	104	36	6	R4594.9
	5.00	0.1969	62	104	36	6	R4595.0
	5.10	0.2008	62	104	36	6	R4595.1
13/64	5.16	0.2031	62	104	36	6	R45913/64
	5.20	0.2047	62	104	36	6	R4595.2
	5.30	0.2087	62	104	36	6	R4595.3
	5.40	0.2126	62	104	36	6	R4595.4
	5.50	0.2165	62	104	36	6	R4595.5
7/32	5.56	0.2189	62	104	36	6	R4597/32
	5.60	0.2205	62	104	36	6	R4595.6
	5.70	0.2244	62	104	36	6	R4595.7
	5.80	0.2283	62	104	36	6	R4595.8

d_1 $\varnothing m_7$ Inch	d_1 $\varnothing m_7$ mm	d_1 decimal Inch	l_2 mm	l_1 mm	l_3 mm	d_2 $\varnothing h_6$ mm	R459
	5.90	0.2323	62	104	36	6	R4595.9
15/64	5.95	0.2343	62	104	36	6	R45915/64
	6.00	0.2362	62	104	36	6	R4596.0
	6.10	0.2402	84	126	36	8	R4596.1
	6.20	0.2441	84	126	36	8	R4596.2
	6.30	0.2480	84	126	36	8	R4596.3
1/4	6.35	0.2500	84	126	36	8	R4591/4
	6.40	0.2520	84	126	36	8	R4596.4
	6.50	0.2559	84	126	36	8	R4596.5
	6.60	0.2598	84	126	36	8	R4596.6
	6.70	0.2638	84	126	36	8	R4596.7
17/64	6.75	0.2657	84	126	36	8	R45917/64
	6.80	0.2677	84	126	36	8	R4596.8
	6.90	0.2717	84	126	36	8	R4596.9
	7.00	0.2756	84	126	36	8	R4597.0
	7.10	0.2795	84	126	36	8	R4597.1
9/32	7.14	0.2811	84	126	36	8	R4599/32
	7.20	0.2835	84	126	36	8	R4597.2
	7.30	0.2874	84	126	36	8	R4597.3
	7.40	0.2913	84	126	36	8	R4597.4
	7.50	0.2953	84	126	36	8	R4597.5
19/64	7.54	0.2969	84	126	36	8	R45919/64
	7.60	0.2992	84	126	36	8	R4597.6
	7.70	0.3031	84	126	36	8	R4597.7
	7.80	0.3071	84	126	36	8	R4597.8
	7.90	0.3110	84	126	36	8	R4597.9
5/16	7.94	0.3126	84	126	36	8	R4595/16
	8.00	0.3150	84	126	36	8	R4598.0
	8.10	0.3189	106	152	40	10	R4598.1
	8.20	0.3228	106	152	40	10	R4598.2
	8.30	0.3268	106	152	40	10	R4598.3
21/64	8.33	0.3280	106	152	40	10	R45921/64
	8.40	0.3307	106	152	40	10	R4598.4
	8.50	0.3346	106	152	40	10	R4598.5
	8.60	0.3386	106	152	40	10	R4598.6
	8.70	0.3425	106	152	40	10	R4598.7
11/32	8.73	0.3437	106	152	40	10	R45911/32
	8.80	0.3465	106	152	40	10	R4598.8
	8.90	0.3504	106	152	40	10	R4598.9
	9.00	0.3543	106	152	40	10	R4599.0
	9.10	0.3583	106	152	40	10	R4599.1
23/64	9.13	0.3594	106	152	40	10	R45923/64
	9.20	0.3622	106	152	40	10	R4599.2
	9.30	0.3661	106	152	40	10	R4599.3
	9.40	0.3701	106	152	40	10	R4599.4
	9.50	0.3740	106	152	40	10	R4599.5
3/8	9.53	0.3748	106	152	40	10	R4593/8
	9.60	0.3780	106	152	40	10	R4599.6
	9.70	0.3819	106	152	40	10	R4599.7
	9.80	0.3858	106	152	40	10	R4599.8
	9.90	0.3898	106	152	40	10	R4599.9
25/64	9.92	0.3906	106	152	40	10	R45925/64
	10.00	0.3937	106	152	40	10	R45910.0
	10.20	0.4016	128	180	45	12	R45910.2
	10.30	0.4055	128	180	45	12	R45910.3
13/32	10.32	0.4063	128	180	45	12	R45913/32
	10.40	0.4094	128	180	45	12	R45910.4
	10.50	0.4134	128	180	45	12	R45910.5
27/64	10.72	0.4220	128	180	45	12	R45927/64
	10.80	0.4252	128	180	45	12	R45910.8
	11.00	0.4331	128	180	45	12	R45911.0
7/16	11.11	0.4374	128	180	45	12	R4597/16
	11.20	0.4409	128	180	45	12	R45911.2
	11.30	0.4449	128	180	45	12	R45911.3
	11.50	0.4528	128	180	45	12	R45911.5
29/64	11.51	0.4531	128	180	45	12	R45929/64
	11.80	0.4646	128	180	45	12	R45911.8
15/32	11.91	0.4689	128	180	45	12	R45915/32
	12.00	0.4724	128	180	45	12	R45912.0
	12.20	0.4803	151	202	48	14	R45912.2

d_1 $\varnothing m_7$ Inch	d_1 $\varnothing m_7$ mm	d_1 decimal Inch	l_2 mm	l_1 mm	l_3 mm	d_2 $\varnothing h_6$ mm	R459
31/64	12.30	0.4843	151	202	48	14	R45931/64
	12.50	0.4921	151	202	48	14	R45912.5
1/2	12.70	0.5000	151	202	48	14	R4591/2
	12.80	0.5039	151	202	48	14	R45912.8
	13.00	0.5118	151	202	48	14	R45913.0
33/64	13.10	0.5157	151	202	48	14	R45933/64
17/32	13.49	0.5311	151	202	48	14	R45917/32
	13.50	0.5315	151	202	48	14	R45913.5
35/64	13.89	0.5469	151	202	48	14	R45935/64
	14.00	0.5512	151	202	48	14	R45914.0
	14.25	0.5610	172	227	48	16	R45914.25
	14.29	0.5626	172	227	48	16	R4599/16
9/16	14.50	0.5709	172	227	48	16	R45914.5
	14.68	0.5780	172	227	48	16	R45937/64
37/64	15.00	0.5906	172	227	48	16	R45915.0
	15.08	0.5937	172	227	48	16	R45919/32
19/32	15.10	0.5945	172	227	48	16	R45915.1
	15.48	0.6094	172	227	48	16	R45939/64
39/64	15.50	0.6102	172	227	48	16	R45915.5
	15.88	0.6252	172	227	48	16	R4595/8
5/8	15.88	0.6252	172	227	48	16	R4595/8
	16.00	0.6299	172	227	48	16	R45916.0

R467

- Force M vrták s vnitřním chlazením, délka 3×D
- Force M Короткое сверло с подводом СОЖ 3×D
- Wiertło typu Force M krótkie z chłodzeniem wew. 3×D
- Force M Vrták krátky, vnútorné chladenie 3×D

R467 ■ 2.1 2.2 2.3 2.4 4.1 4.2 4.3
 • 5.1 5.2 5.3

R467

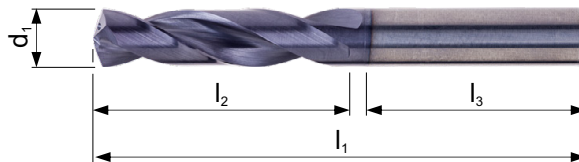

d ₁ Ø "/Nr./letter	d ₁ Øm ₇ mm	d ₁ decimal Inch	l ₂ mm	l ₁ mm	l ₃ mm	d ₂ Øh ₆ mm	R467
1/8	3.00	0.1181	20	62	36	6	R4673.0
	3.10	0.1220	20	62	36	6	R4673.1
	3.18	0.1250	20	62	36	6	R4671/8
	3.20	0.1260	20	62	36	6	R4673.2
	3.30	0.1299	20	62	36	6	R4673.3
29	3.40	0.1339	20	62	36	6	R4673.4
	3.45	0.1360	20	62	36	6	R467N29
	3.50	0.1378	20	62	36	6	R4673.5
	3.57	0.1406	20	62	36	6	R4679/64
9/64	3.60	0.1417	20	62	36	6	R4673.6
	3.70	0.1457	20	62	36	6	R4673.7
	3.80	0.1496	24	66	36	6	R4673.8
	3.90	0.1535	24	66	36	6	R4673.9
	3.97	0.1563	24	66	36	6	R4675/32
	4.00	0.1575	24	66	36	6	R4674.0
	4.05	0.1594	24	66	36	6	R4674.05
	4.10	0.1614	24	66	36	6	R4674.1
	4.20	0.1654	24	66	36	6	R4674.2
	4.30	0.1693	24	66	36	6	R4674.3
11/64	4.37	0.1719	24	66	36	6	R46711/64
	4.40	0.1732	24	66	36	6	R4674.4
	4.50	0.1772	24	66	36	6	R4674.5
	4.60	0.1811	24	66	36	6	R4674.6
	4.70	0.1850	24	66	36	6	R4674.7
3/16	4.76	0.1875	28	66	36	6	R4673/16
	4.80	0.1890	28	66	36	6	R4674.8
	4.90	0.1929	28	66	36	6	R4674.9
	5.00	0.1969	28	66	36	6	R4675.0
	5.05	0.1988	28	66	36	6	R4675.05
7	5.10	0.2008	28	66	36	6	R4675.1
	5.11	0.2010	28	66	36	6	R467N7
	5.16	0.2031	28	66	36	6	R46713/64
	5.20	0.2047	28	66	36	6	R4675.2
5	5.22	0.2055	28	66	36	6	R467N5
	5.30	0.2087	28	66	36	6	R4675.3
	5.40	0.2126	28	66	36	6	R4675.4
	5.50	0.2165	28	66	36	6	R4675.5
7/32	5.56	0.2188	28	66	36	6	R4677/32

d_1 Ø "Nr./letter	d_1 Ø _{m7} mm	d_1 decimal Inch	l_2 mm	l_1 mm	l_3 mm	d_2 Ø _{h6} mm	R467
	5.60	0.2205	28	66	36	6	R4675.6
	5.70	0.2244	28	66	36	6	R4675.7
	5.80	0.2283	28	66	36	6	R4675.8
	5.90	0.2323	28	66	36	6	R4675.9
15/64	5.95	0.2344	28	66	36	6	R46715/64
	6.00	0.2362	28	66	36	6	R4676.0
	6.05	0.2382	34	79	36	8	R4676.05
	6.10	0.2402	34	79	36	8	R4676.1
	6.20	0.2441	34	79	36	8	R4676.2
	6.30	0.2480	34	79	36	8	R4676.3
1/4	6.35	0.2500	34	79	36	8	R4671/4
	6.40	0.2520	34	79	36	8	R4676.4
	6.50	0.2559	34	79	36	8	R4676.5
	6.60	0.2598	34	79	36	8	R4676.6
	6.70	0.2638	34	79	36	8	R4676.7
17/64	6.75	0.2656	34	79	36	8	R46717/64
	6.80	0.2677	34	79	36	8	R4676.8
	6.90	0.2717	34	79	36	8	R4676.9
	7.00	0.2756	34	79	36	8	R4677.0
	7.10	0.2795	41	79	36	8	R4677.1
9/32	7.14	0.2813	41	79	36	8	R4679/32
	7.20	0.2835	41	79	36	8	R4677.2
	7.30	0.2874	41	79	36	8	R4677.3
	7.40	0.2913	41	79	36	8	R4677.4
	7.50	0.2953	41	79	36	8	R4677.5
19/64	7.54	0.2969	41	79	36	8	R46719/64
	7.60	0.2992	41	79	36	8	R4677.6
	7.70	0.3031	41	79	36	8	R4677.7
	7.80	0.3071	41	79	36	8	R4677.8
	7.90	0.3110	41	79	36	8	R4677.9
5/16	7.94	0.3125	41	79	36	8	R4675/16
	8.00	0.3150	41	79	36	8	R4678.0
	8.05	0.3169	47	89	40	10	R4678.05
	8.10	0.3189	47	89	40	10	R4678.1
	8.20	0.3228	47	89	40	10	R4678.2
	8.30	0.3268	47	89	40	10	R4678.3
21/64	8.33	0.3281	47	89	40	10	R46721/64
	8.40	0.3307	47	89	40	10	R4678.4
	8.50	0.3346	47	89	40	10	R4678.5
	8.60	0.3386	47	89	40	10	R4678.6
	8.70	0.3425	47	89	40	10	R4678.7
11/32	8.73	0.3438	47	89	40	10	R46711/32
	8.80	0.3465	47	89	40	10	R4678.8
	8.90	0.3504	47	89	40	10	R4678.9
	9.00	0.3543	47	89	40	10	R4679.0
	9.10	0.3583	47	89	40	10	R4679.1
23/64	9.13	0.3594	47	89	40	10	R46723/64
	9.20	0.3622	47	89	40	10	R4679.2
	9.30	0.3661	47	89	40	10	R4679.3
	9.40	0.3701	47	89	40	10	R4679.4
	9.50	0.3740	47	89	40	10	R4679.5
3/8	9.53	0.3750	47	89	40	10	R4673/8
	9.60	0.3780	47	89	40	10	R4679.6
	9.70	0.3819	47	89	40	10	R4679.7
	9.80	0.3858	47	89	40	10	R4679.8
	9.90	0.3898	47	89	40	10	R4679.9
25/64	9.92	0.3906	47	89	40	10	R46725/64
	10.00	0.3937	47	89	40	10	R46710.0
	10.05	0.3957	55	102	45	12	R46710.05
	10.10	0.3976	55	102	45	12	R46710.1
	10.20	0.4016	55	102	45	12	R46710.2
	10.30	0.4055	55	102	45	12	R46710.3
13/32	10.32	0.4063	55	102	45	12	R46713/32
	10.40	0.4094	55	102	45	12	R46710.4
	10.50	0.4134	55	102	45	12	R46710.5
	10.60	0.4173	55	102	45	12	R46710.6
27/64	10.72	0.4219	55	102	45	12	R46727/64
	10.80	0.4252	55	102	45	12	R46710.8
	10.90	0.4291	55	102	45	12	R46710.9
	11.00	0.4331	55	102	45	12	R46711.0

d_1 \emptyset "/Nr./letter	d_1 $\emptyset m_7$ mm	d_1 decimal Inch	l_2 mm	l_1 mm	l_3 mm	d_2 $\emptyset h_6$ mm	R467
7/16	11.11	0.4375	55	102	45	12	R4677/16
	11.20	0.4409	55	102	45	12	R46711.2
	11.30	0.4449	55	102	45	12	R46711.3
	11.40	0.4488	55	102	45	12	R46711.4
29/64	11.50	0.4528	55	102	45	12	R46711.5
	11.51	0.4531	55	102	45	12	R46729/64
	11.60	0.4567	55	102	45	12	R46711.6
15/32	11.80	0.4646	55	102	45	12	R46711.8
	11.91	0.4688	55	102	45	12	R46715/32
	12.00	0.4724	55	102	45	12	R46712.0
	12.05	0.4744	60	107	45	14	R46712.05
31/64	12.10	0.4764	60	107	45	14	R46712.1
	12.20	0.4803	60	107	45	14	R46712.2
	12.30	0.4844	60	107	45	14	R46731/64
	12.50	0.4921	60	107	45	14	R46712.5
1/2	12.70	0.5000	60	107	45	14	R46712.7
	12.70	0.5000	60	107	45	14	R4671/2
	12.80	0.5039	60	107	45	14	R46712.8
33/64	13.00	0.5118	60	107	45	14	R46713.0
	13.10	0.5156	60	107	45	14	R46733/64
	13.30	0.5236	60	107	45	14	R46713.3
17/32	13.49	0.5313	60	107	45	14	R46717/32
	13.50	0.5315	60	107	45	14	R46713.5
35/64	13.80	0.5433	60	107	45	14	R46713.8
	13.89	0.5469	60	107	45	14	R46735/64
	14.00	0.5512	60	107	45	14	R46714.0
	14.25	0.5610	65	115	48	16	R46714.25
9/16	14.29	0.5625	65	115	48	16	R4679/16
	14.50	0.5709	65	115	48	16	R46714.5
37/64	14.68	0.5781	65	115	48	16	R46737/64
	14.80	0.5827	65	115	48	16	R46714.8
	15.00	0.5906	65	115	48	16	R46715.0
19/32	15.08	0.5938	65	115	48	16	R46719/32
	15.10	0.5945	65	115	48	16	R46715.1
	15.30	0.6024	65	115	48	16	R46715.3
39/64	15.48	0.6094	65	115	48	16	R46739/64
	15.50	0.6102	65	115	48	16	R46715.5
	15.80	0.6220	65	115	48	16	R46715.8
5/8	15.88	0.6250	65	115	48	16	R4675/8
	16.00	0.6299	65	115	48	16	R46716.0

R463

- Force M vrták s vnitřním chlazením, délka 5×D
- Force M Короткое сверло с подводом СОЖ 5×D
- Wiertło typu Force M krótkie z chłodzeniem wew. 5×D
- Force M Vrták krátky, vnútorné chladienie 5×D

R463 ■ 2.1 2.2 2.3 2.4 4.1 4.2 4.3
 • 5.1 5.2 5.3

R463

HM

DIN
6537
L

5XD

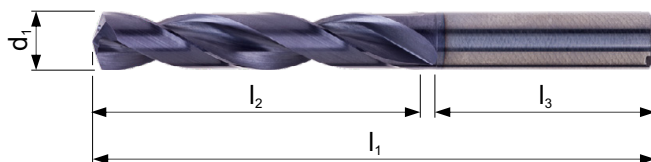

R463



FORCE M
3.00 - 16.00

d ₁ Ø "/Nr./letter	d ₁ Øm ₇ mm	d ₁ decimal Inch	l ₂ mm	l ₁ mm	l ₃ mm	d ₂ Øh ₆ mm	R463
	3.00	0.1181	28	66	36	6	R4633.0
	3.10	0.1220	28	66	36	6	R4633.1
1/8	3.18	0.1250	28	66	36	6	R4631/8
	3.20	0.1260	28	66	36	6	R4633.2
	3.30	0.1299	28	66	36	6	R4633.3
	3.40	0.1339	28	66	36	6	R4633.4
29	3.45	0.1360	28	66	36	6	R463N29
	3.50	0.1378	28	66	36	6	R4633.5
9/64	3.57	0.1406	28	66	36	6	R4639/64
	3.60	0.1417	28	66	36	6	R4633.6
	3.70	0.1457	28	66	36	6	R4633.7
	3.80	0.1496	36	74	36	6	R4633.8
	3.90	0.1535	36	74	36	6	R4633.9
5/32	3.97	0.1563	36	74	36	6	R4635/32
	4.00	0.1575	36	74	36	6	R4634.0
	4.05	0.1594	36	74	36	6	R4634.05
	4.10	0.1614	36	74	36	6	R4634.1
	4.20	0.1654	36	74	36	6	R4634.2
	4.30	0.1693	36	74	36	6	R4634.3
11/64	4.37	0.1719	36	74	36	6	R46311/64
	4.40	0.1732	36	74	36	6	R4634.4
	4.50	0.1772	36	74	36	6	R4634.5
	4.60	0.1811	36	74	36	6	R4634.6
	4.70	0.1850	36	74	36	6	R4634.7
3/16	4.76	0.1875	44	82	36	6	R4633/16
	4.80	0.1890	44	82	36	6	R4634.8
	4.90	0.1929	44	82	36	6	R4634.9
	5.00	0.1969	44	82	36	6	R4635.0
	5.05	0.1988	44	82	36	6	R4635.05
	5.10	0.2008	44	82	36	6	R4635.1
7	5.11	0.2010	44	82	36	6	R463N7
13/64	5.16	0.2031	44	82	36	6	R46313/64
	5.20	0.2047	44	82	36	6	R4635.2
5	5.22	0.2055	44	82	36	6	R463N5
	5.30	0.2087	44	82	36	6	R4635.3
	5.40	0.2126	44	82	36	6	R4635.4
	5.50	0.2165	44	82	36	6	R4635.5
7/32	5.56	0.2188	44	82	36	6	R4637/32

d_1 Ø "/Nr./letter	d_1 Øm ₇ mm	d_1 decimal Inch	l_2 mm	l_1 mm	l_3 mm	d_2 Øh ₆ mm	R463
	5.60	0.2205	44	82	36	6	R4635.6
	5.70	0.2244	44	82	36	6	R4635.7
	5.80	0.2283	44	82	36	6	R4635.8
	5.90	0.2323	44	82	36	6	R4635.9
15/64	5.95	0.2344	44	82	36	6	R46315/64
	6.00	0.2362	44	82	36	6	R4636.0
	6.05	0.2382	53	91	36	8	R4636.05
	6.10	0.2402	53	91	36	8	R4636.1
	6.20	0.2441	53	91	36	8	R4636.2
	6.30	0.2480	53	91	36	8	R4636.3
1/4	6.35	0.2500	53	91	36	8	R4631/4
	6.40	0.2520	53	91	36	8	R4636.4
	6.50	0.2559	53	91	36	8	R4636.5
	6.60	0.2598	53	91	36	8	R4636.6
	6.70	0.2638	53	91	36	8	R4636.7
17/64	6.75	0.2656	53	91	36	8	R46317/64
	6.80	0.2677	53	91	36	8	R4636.8
	6.90	0.2717	53	91	36	8	R4636.9
	7.00	0.2756	53	91	36	8	R4637.0
	7.10	0.2795	53	91	36	8	R4637.1
9/32	7.14	0.2813	53	91	36	8	R4639/32
	7.20	0.2835	53	91	36	8	R4637.2
	7.30	0.2874	53	91	36	8	R4637.3
	7.40	0.2913	53	91	36	8	R4637.4
	7.50	0.2953	53	91	36	8	R4637.5
19/64	7.54	0.2969	53	91	36	8	R46319/64
	7.60	0.2992	53	91	36	8	R4637.6
	7.70	0.3031	53	91	36	8	R4637.7
	7.80	0.3071	53	91	36	8	R4637.8
	7.90	0.3110	53	91	36	8	R4637.9
5/16	7.94	0.3125	53	91	36	8	R4635/16
	8.00	0.3150	53	91	36	8	R4638.0
	8.05	0.3169	61	103	40	10	R4638.05
	8.10	0.3189	61	103	40	10	R4638.1
	8.20	0.3228	61	103	40	10	R4638.2
	8.30	0.3268	61	103	40	10	R4638.3
21/64	8.33	0.3281	61	103	40	10	R46321/64
	8.40	0.3307	61	103	40	10	R4638.4
	8.50	0.3346	61	103	40	10	R4638.5
	8.60	0.3386	61	103	40	10	R4638.6
	8.70	0.3425	61	103	40	10	R4638.7
11/32	8.73	0.3438	61	103	40	10	R46311/32
	8.80	0.3465	61	103	40	10	R4638.8
	8.90	0.3504	61	103	40	10	R4638.9
	9.00	0.3543	61	103	40	10	R4639.0
	9.10	0.3583	61	103	40	10	R4639.1
23/64	9.13	0.3594	61	103	40	10	R46323/64
	9.20	0.3622	61	103	40	10	R4639.2
	9.30	0.3661	61	103	40	10	R4639.3
	9.40	0.3701	61	103	40	10	R4639.4
	9.50	0.3740	61	103	40	10	R4639.5
3/8	9.53	0.3750	61	103	40	10	R4633/8
	9.60	0.3780	61	103	40	10	R4639.6
	9.70	0.3819	61	103	40	10	R4639.7
	9.80	0.3858	61	103	40	10	R4639.8
	9.90	0.3898	61	103	40	10	R4639.9
25/64	9.92	0.3906	61	103	40	10	R46325/64
	10.00	0.3937	61	103	40	10	R46310.0
	10.05	0.3957	70	118	45	12	R46310.05
	10.10	0.3976	70	118	45	12	R46310.1
	10.20	0.4016	70	118	45	12	R46310.2
	10.30	0.4055	70	118	45	12	R46310.3
13/32	10.32	0.4063	70	118	45	12	R46313/32
	10.40	0.4094	70	118	45	12	R46310.4
	10.50	0.4134	70	118	45	12	R46310.5
	10.60	0.4173	70	118	45	12	R46310.6
27/64	10.72	0.4219	70	118	45	12	R46327/64
	10.80	0.4252	70	118	45	12	R46310.8
	10.90	0.4291	70	118	45	12	R46310.9
	11.00	0.4331	70	118	45	12	R46311.0

d_1 Ø "/Nr./letter	d_1 Ø m_7 mm	d_1 decimal Inch	l_2 mm	l_1 mm	l_3 mm	d_2 Ø h_6 mm	R463
7/16	11.11	0.4375	70	118	45	12	R4637/16
	11.20	0.4409	70	118	45	12	R46311.2
	11.30	0.4449	70	118	45	12	R46311.3
	11.40	0.4488	70	118	45	12	R46311.4
	11.50	0.4528	70	118	45	12	R46311.5
29/64	11.51	0.4531	70	118	45	12	R46329/64
	11.60	0.4567	70	118	45	12	R46311.6
	11.80	0.4646	70	118	45	12	R46311.8
15/32	11.91	0.4688	70	118	45	12	R46315/32
	12.00	0.4724	70	118	45	12	R46312.0
	12.05	0.4744	76	124	45	14	R46312.05
31/64	12.20	0.4803	76	124	45	14	R46312.2
	12.30	0.4844	76	124	45	14	R46331/64
	12.50	0.4921	76	124	45	14	R46312.5
	12.70	0.5000	76	124	45	14	R46312.7
1/2	12.70	0.5000	76	124	45	14	R4631/2
	12.80	0.5039	76	124	45	14	R46312.8
	13.00	0.5118	76	124	45	14	R46313.0
33/64	13.10	0.5156	76	124	45	14	R46333/64
	13.30	0.5236	76	124	45	14	R46313.3
17/32	13.49	0.5313	76	124	45	14	R46317/32
	13.50	0.5315	76	124	45	14	R46313.5
	13.80	0.5433	76	124	45	14	R46313.8
35/64	13.89	0.5469	76	124	45	14	R46335/64
	14.00	0.5512	76	124	45	14	R46314.0
	14.25	0.5610	82	133	48	16	R46314.25
9/16	14.29	0.5625	82	133	48	16	R4639/16
	14.50	0.5709	82	133	48	16	R46314.5
37/64	14.68	0.5781	82	133	48	16	R46337/64
	14.80	0.5827	82	133	48	16	R46314.8
	15.00	0.5906	82	133	48	16	R46315.0
19/32	15.08	0.5938	82	133	48	16	R46319/32
	15.10	0.5945	82	133	48	16	R46315.1
	15.30	0.6024	82	133	48	16	R46315.3
39/64	15.48	0.6094	82	133	48	16	R46339/64
	15.50	0.6102	82	133	48	16	R46315.5
	15.80	0.6220	82	133	48	16	R46315.8
5/8	15.88	0.6250	82	133	48	16	R4635/8
	16.00	0.6299	82	133	48	16	R46316.0

A723

- Vrták na bodové svary
- Сверло для высверливания сварных точек
- Wiertło do zgrzewów punktowych
- Vrták na odstraňovanie bodových zvarov

A723 ■ 1.1 1.2
 • 1.3 1.4

A723 HSS-E DORMER 1XD Bronze N

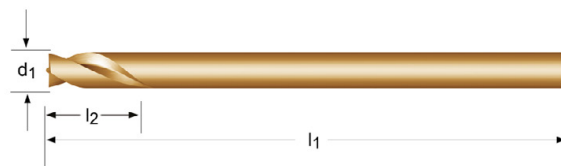

d_1 \varnothing_{h_8} mm	d_1 decimal inch	l_2 mm	l_1 mm	A723
6.00	0.2362	18	66	A7236.0X66
6.00	0.2362	18	93	A7236.0X93
8.00	0.3150	24	79	A7238.0X79
8.00	0.3150	24	117	A7238.0X117

A122

- Navrtávák
- Центровочное сверло для станков с ЧПУ
- Wiertło do nawiercania
- Navrtávák

Celková délka dle DIN 1897
 Общая длина согласно DIN 1897
 Długość całkowita zgodnie z DIN 1897
 Celková dĺžka podľa DIN 1897

A122	▪	1.1	1.2	1.3	6.1	6.2	6.3	6.4	7.1	7.2											
	•	1.4	1.5	1.6	2.1	2.2	2.3	3.1	3.2	3.3	3.4	4.1	4.2	4.3	5.1	5.2	5.3	7.3	7.4	8.1	8.2
		8.3	9.1																		

A122 HSS DIN 1897 1XD 90°/120° N

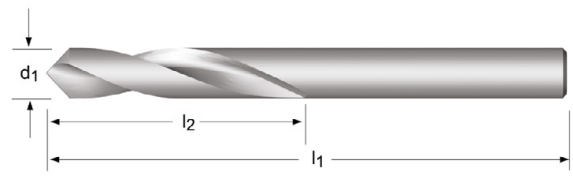

d_1 \varnothing_{h_8} mm	d_1 decimal Inch	l_2 mm	l_1 mm	A122
6.00	0.2362	30	66	A1226.0X90
6.00	0.2362	30	66	A1226.0X120
8.00	0.3150	33	79	A1228.0X90
8.00	0.3150	33	79	A1228.0X120
10.00	0.3937	35	89	A12210.0X90
10.00	0.3937	35	89	A12210.0X120
12.00	0.4724	40	102	A12212.0X90
12.00	0.4724	40	102	A12212.0X120
16.00	0.6299	40	115	A12216.0X90
16.00	0.6299	40	115	A12216.0X120
20.00	0.7874	55	131	A12220.0X90
20.00	0.7874	55	131	A12220.0X120

- A119**
- Navrtávák oboustranný
 - Двухстороннее спиральное сверло
 - Wiertło krótkie dwustronne
 - Navrtávák obojstranný
- Krátky obojstranný vrták
 Двухстороннее сверло для листового металла
 Wiertło do blach
 Vrták na plechy

A119	▪	1.1	1.2																		
	•	1.3	1.4	1.5	1.6	2.1	2.2	2.3	4.1	4.2	4.3	5.1	5.2	5.3	6.1	6.2	6.3	6.4	7.1	7.2	7.3
		7.4	8.1	8.2																	

A119 HSS DIN 1897 1.25XD 120° ST N

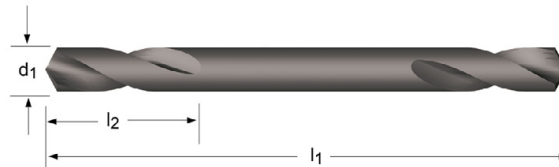

d_1 $\varnothing h_8$ mm	d_1 decimal Inch	l_2 mm	l_1 mm	A119
3.30	0.1299	11	49	A1193.3
3.60	0.1417	12	52	A1193.6
4.10	0.1614	14	55	A1194.1
4.20	0.1654	14	55	A1194.2
4.90	0.1929	17	62	A1194.9
5.10	0.2008	17	62	A1195.1

A123

- Navrtávák
- Спиральное сверло, укороченное исполнение
- Wiertło krótkie
- Navrtávák

Celková délka dle DIN 1897 a vrták pro vrtání do plechu
 Общая длина согласно DIN 1897, сверло по листовому металлу
 Wiertło do blach. Całkowita długość zgodna z DIN 1897.
 Celková dĺžka podľa DIN 1897 a vrták na vrtanie do plechu

A123	▪	1.1	1.2	1.3	6.1	6.2	6.3	6.4	7.1	7.2										
	•	1.4	1.5	1.6	2.1	2.2	2.3	4.1	4.2	4.3	5.1	5.2	5.3	7.3	7.4	8.1	8.2	8.3	9.1	

A123

HSS

DIN
1897

1.5XD



N

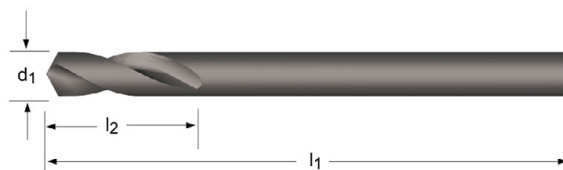

A123



3/32 - 1/4

d_1 \varnothing_{h_8} Inch	d_1 \varnothing_{h_8} mm	d_1 decimal Inch	l_2 mm	l_1 mm	A123
3/32	2.38	0.0937	14	43	A1233/32S
	2.50	0.0984	14	43	A1232.5S
	3.00	0.1181	16	46	A1233.0S
1/8	3.18	0.1252	18	49	A1231/8S
	3.20	0.1260	18	49	A1233.2S
	3.30	0.1299	18	49	A1233.3S
	3.50	0.1378	18	52	A1233.5S
	3.70	0.1457	18	52	A1233.7S
5/32	3.97	0.1563	18	55	A1235/32S
	4.00	0.1575	18	55	A1234.0S
	4.10	0.1614	18	55	A1234.1S
	4.20	0.1654	18	55	A1234.2S
	4.50	0.1772	18	58	A1234.5S
3/16	4.76	0.1874	18	62	A1233/16S
	4.80	0.1890	18	62	A1234.8S
	4.90	0.1929	18	62	A1234.9S
	5.00	0.1969	18	62	A1235.0S
	5.50	0.2165	18	66	A1235.5S
7/32	5.56	0.2189	18	66	A1237/32S
	6.00	0.2362	18	66	A1236.0S
1/4	6.35	0.2500	19	70	A1231/4S

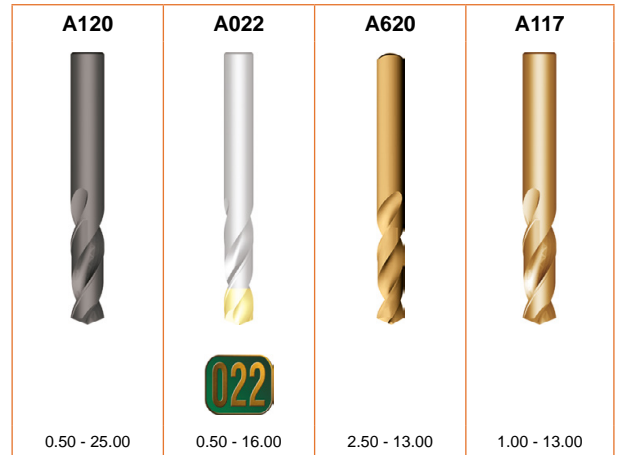
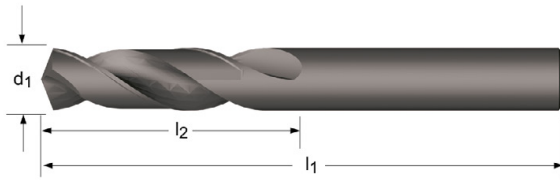

d_1 $\varnothing h_8$ Inch	d_1 $\varnothing h_8$ mm	d_1 decimal Inch	l_2 mm	l_1 mm	A120	A022	A620	A117
	0.50	0.0197	3	20	A120.5	A022.5		
	0.60	0.0236	3.5	21	A120.6	A022.6		
	0.70	0.0276	4.5	23	A120.7	A022.7		
1/32	0.79	0.0311	13	35		A0221/32		
1/32	0.79	0.0311	5	24	A1201/32			
	0.80	0.0315	5	24	A120.8	A022.8		
	0.90	0.0354	5.5	25	A120.9	A022.9		
	1.00	0.0394	6	26	A1201.0	A0221.0		A1171.0
	1.10	0.0433	7	28	A1201.1	A0221.1		A1171.1
3/64	1.19	0.0469	13	35		A0223/64		
3/64	1.19	0.0469	8	30	A1203/64			
	1.20	0.0472	8	30	A1201.2	A0221.2		A1171.2
	1.30	0.0512	8	30	A1201.3	A0221.3		A1171.3
	1.40	0.0551	9	32	A1201.4	A0221.4		A1171.4
	1.50	0.0591	9	32	A1201.5	A0221.5		A1171.5
1/16	1.59	0.0626	10	34	A1201/16			
1/16	1.59	0.0626	16	41		A0221/16		
	1.60	0.0630	10	34	A1201.6	A0221.6		A1171.6
	1.70	0.0669	10	34	A1201.7	A0221.7		A1171.7
	1.80	0.0709	11	36	A1201.8	A0221.8		A1171.8
	1.90	0.0748	11	36	A1201.9	A0221.9		A1171.9
5/64	1.98	0.0780	12	38	A1205/64			
5/64	1.98	0.0780	17	43		A0225/64		
	2.00	0.0787	12	38	A1202.0	A0222.0		A1172.0
	2.10	0.0827	12	38	A1202.1	A0222.1		A1172.1
	2.20	0.0866	13	40	A1202.2	A0222.2		A1172.2
	2.25	0.0886	13	40	A1202.25	A0222.25		
	2.30	0.0906	13	40	A1202.3	A0222.3		A1172.3
3/32	2.38	0.0937	14	43	A1203/32			
3/32	2.38	0.0937	20	45		A0223/32		
	2.40	0.0945	14	43	A1202.4	A0222.4		A1172.4
	2.50	0.0984	14	43	A1202.5	A0222.5	A6202.5	A1172.5
	2.60	0.1024	14	43	A1202.6	A0222.6	A6202.6	A1172.6
	2.65	0.1043	14	43	A1202.65	A0222.65		
	2.70	0.1063	16	46	A1202.7	A0222.7	A6202.7	A1172.7
7/64	2.78	0.1094	16	46	A1207/64			
7/64	2.78	0.1094	22	47		A0227/64		
	2.80	0.1102	16	46	A1202.8	A0222.8	A6202.8	A1172.8
	2.90	0.1142	16	46	A1202.9	A0222.9	A6202.9	A1172.9
	3.00	0.1181	16	46	A1203.0	A0223.0	A6203.0	A1173.0
	3.10	0.1220	18	49	A1203.1	A0223.1	A6203.1	A1173.1
1/8	3.18	0.1252	18	49	A1201/8			A1171/8
1/8	3.18	0.1252	23	49		A0221/8		
	3.20	0.1260	18	49	A1203.2	A0223.2	A6203.2	A1173.2
	3.25	0.1280	18	49	A1203.25	A0223.25		
	3.30	0.1299	18	49	A1203.3	A0223.3	A6203.3	A1173.3
	3.40	0.1339	20	52	A1203.4	A0223.4	A6203.4	A1173.4
	3.50	0.1378	20	52	A1203.5	A0223.5	A6203.5	A1173.5
9/64	3.57	0.1406	20	52	A1209/64			
9/64	3.57	0.1406	25	50		A0229/64		
	3.60	0.1417	20	52	A1203.6	A0223.6	A6203.6	A1173.6
	3.70	0.1457	20	52	A1203.7	A0223.7	A6203.7	A1173.7
	3.80	0.1496	22	55	A1203.8	A0223.8	A6203.8	A1173.8
	3.90	0.1535	22	55	A1203.9	A0223.9	A6203.9	A1173.9

d_1 \varnothing_{h_8} Inch	d_1 \varnothing_{h_8} mm	d_1 decimal Inch	l_2 mm	l_1 mm	A120	A022	A620	A117
5/32	3.97	0.1563	22	55	A1205/32			A1175/32
5/32	3.97	0.1563	26	53		A0225/32		
	4.00	0.1575	22	55	A1204.0	A0224.0	A6204.0	A1174.0
	4.10	0.1614	22	55	A1204.1	A0224.1	A6204.1	A1174.1
	4.20	0.1654	22	55	A1204.2	A0224.2	A6204.2	A1174.2
	4.30	0.1693	24	58	A1204.3	A0224.3	A6204.3	A1174.3
11/64	4.37	0.1720	24	58	A12011/64			
11/64	4.37	0.1720	28	55		A02211/64		
	4.40	0.1732	24	58	A1204.4	A0224.4	A6204.4	A1174.4
	4.50	0.1772	24	58	A1204.5	A0224.5	A6204.5	A1174.5
	4.60	0.1811	24	58	A1204.6	A0224.6	A6204.6	A1174.6
	4.70	0.1850	24	58	A1204.7	A0224.7	A6204.7	A1174.7
3/16	4.76	0.1874	26	62	A1203/16			A1173/16
3/16	4.76	0.1874	30	57		A0223/16		
	4.80	0.1890	26	62	A1204.8	A0224.8	A6204.8	A1174.8
	4.90	0.1929	26	62	A1204.9	A0224.9	A6204.9	A1174.9
	5.00	0.1969	26	62	A1205.0	A0225.0	A6205.0	A1175.0
	5.10	0.2008	26	62	A1205.1	A0225.1	A6205.1	A1175.1
13/64	5.16	0.2031	26	62	A12013/64			
13/64	5.16	0.2031	31	58		A02213/64		
	5.20	0.2047	26	62	A1205.2	A0225.2	A6205.2	A1175.2
	5.30	0.2087	26	62	A1205.3	A0225.3	A6205.3	A1175.3
	5.40	0.2126	28	66	A1205.4	A0225.4	A6205.4	A1175.4
	5.50	0.2165	28	66	A1205.5	A0225.5	A6205.5	A1175.5
7/32	5.56	0.2189	28	66	A1207/32			
7/32	5.56	0.2189	33	61		A0227/32		
	5.60	0.2205	28	66	A1205.6	A0225.6	A6205.6	A1175.6
	5.70	0.2244	28	66	A1205.7	A0225.7	A6205.7	A1175.7
	5.80	0.2283	28	66	A1205.8	A0225.8	A6205.8	A1175.8
	5.90	0.2323	28	66	A1205.9	A0225.9	A6205.9	A1175.9
15/64	5.95	0.2343	28	66	A12015/64			
15/64	5.95	0.2343	34	63		A02215/64		
	6.00	0.2362	28	66	A1206.0	A0226.0	A6206.0	A1176.0
	6.10	0.2402	31	70	A1206.1	A0226.1	A6206.1	A1176.1
	6.20	0.2441	31	70	A1206.2	A0226.2	A6206.2	A1176.2
	6.30	0.2480	31	70	A1206.3	A0226.3	A6206.3	A1176.3
1/4	6.35	0.2500	31	70	A1201/4			A1171/4
1/4	6.35	0.2500	36	65		A0221/4		
	6.40	0.2520	31	70	A1206.4	A0226.4	A6206.4	A1176.4
	6.50	0.2559	31	70	A1206.5	A0226.5	A6206.5	A1176.5
	6.60	0.2598	31	70	A1206.6	A0226.6	A6206.6	A1176.6
	6.70	0.2638	31	70	A1206.7	A0226.7	A6206.7	A1176.7
	6.80	0.2677	34	74	A1206.8	A0226.8	A6206.8	A1176.8
	6.90	0.2717	34	74	A1206.9	A0226.9	A6206.9	A1176.9
	7.00	0.2756	34	74	A1207.0	A0227.0	A6207.0	A1177.0
	7.10	0.2795	34	74	A1207.1	A0227.1	A6207.1	A1177.1
9/32	7.14	0.2811	34	74	A1209/32			
9/32	7.14	0.2811	40	70		A0229/32		
	7.20	0.2835	34	74	A1207.2	A0227.2	A6207.2	A1177.2
	7.30	0.2874	34	74	A1207.3	A0227.3	A6207.3	A1177.3
	7.40	0.2913	34	74	A1207.4	A0227.4	A6207.4	A1177.4
	7.50	0.2953	34	74	A1207.5	A0227.5	A6207.5	A1177.5
	7.60	0.2992	37	79	A1207.6	A0227.6	A6207.6	A1177.6
	7.70	0.3031	37	79	A1207.7	A0227.7	A6207.7	A1177.7
	7.80	0.3071	37	79	A1207.8	A0227.8	A6207.8	A1177.8
	7.90	0.3110	37	79	A1207.9	A0227.9	A6207.9	A1177.9
5/16	7.94	0.3126	37	79	A1205/16			A1175/16
5/16	7.94	0.3126	43	73		A0225/16		
	8.00	0.3150	37	79	A1208.0	A0228.0	A6208.0	A1178.0
	8.10	0.3189	37	79	A1208.1	A0228.1	A6208.1	A1178.1
	8.20	0.3228	37	79	A1208.2	A0228.2	A6208.2	A1178.2
	8.30	0.3268	37	79	A1208.3	A0228.3	A6208.3	A1178.3
	8.40	0.3307	37	79	A1208.4	A0228.4	A6208.4	A1178.4
	8.50	0.3346	37	79	A1208.5	A0228.5	A6208.5	A1178.5
	8.60	0.3386	40	84	A1208.6	A0228.6	A6208.6	A1178.6
	8.70	0.3425	40	84	A1208.7	A0228.7	A6208.7	A1178.7
11/32	8.73	0.3437	40	84	A12011/32			
11/32	8.73	0.3437	45	78		A02211/32		
	8.80	0.3465	40	84	A1208.8	A0228.8	A6208.8	A1178.8
	8.90	0.3504	40	84	A1208.9	A0228.9	A6208.9	A1178.9
	9.00	0.3543	40	84	A1209.0	A0229.0	A6209.0	A1179.0
	9.10	0.3583	40	84	A1209.1	A0229.1	A6209.1	A1179.1

d_1 $\varnothing h_8$ Inch	d_1 $\varnothing h_8$ mm	d_1 decimal Inch	l_2 mm	l_1 mm	A120	A022	A620	A117
	9.20	0.3622	40	84	A1209.2	A0229.2	A6209.2	A1179.2
	9.30	0.3661	40	84	A1209.3	A0229.3	A6209.3	A1179.3
	9.40	0.3701	40	84	A1209.4	A0229.4	A6209.4	A1179.4
	9.50	0.3740	40	84	A1209.5	A0229.5	A6209.5	A1179.5
3/8	9.52	0.3748	43	89	A1203/8			A1173/8
3/8	9.52	0.3748	48	81		A0223/8		
	9.60	0.3780	43	89	A1209.6	A0229.6	A6209.6	A1179.6
	9.70	0.3819	43	89	A1209.7	A0229.7	A6209.7	A1179.7
	9.80	0.3858	43	89	A1209.8	A0229.8	A6209.8	A1179.8
	9.90	0.3898	43	89	A1209.9	A0229.9	A6209.9	A1179.9
	10.00	0.3937	43	89	A12010.0	A02210.0	A62010.0	A11710.0
	10.10	0.3976	43	89	A12010.1	A02210.1		
	10.20	0.4016	43	89	A12010.2	A02210.2	A62010.2	A11710.2
	10.30	0.4055	43	89	A12010.3	A02210.3	A62010.3	
13/32	10.32	0.4063	43	89	A12013/32			
13/32	10.32	0.4063	51	86		A02213/32		
	10.40	0.4094	43	89	A12010.4	A02210.4	A62010.4	
	10.50	0.4134	43	89	A12010.5	A02210.5	A62010.5	A11710.5
	10.60	0.4173	43	89	A12010.6	A02210.6		
	10.70	0.4213	47	95	A12010.7	A02210.7		
	10.80	0.4252	47	95	A12010.8	A02210.8	A62010.8	
	10.90	0.4291	47	95	A12010.9	A02210.9		
	11.00	0.4331	47	95	A12011.0	A02211.0	A62011.0	A11711.0
	11.10	0.4370	47	95	A12011.1	A02211.1		
7/16	11.11	0.4374	47	95	A1207/16			
7/16	11.11	0.4374	54	89		A0227/16		
	11.20	0.4409	47	95	A12011.2	A02211.2		
	11.30	0.4449	47	95	A12011.3	A02211.3		
	11.50	0.4528	47	95	A12011.5	A02211.5	A62011.5	A11711.5
	11.60	0.4567	47	95	A12011.6	A02211.6		
	11.70	0.4606	47	95	A12011.7	A02211.7		
	11.80	0.4646	47	95	A12011.8	A02211.8		
	11.90	0.4685	51	102	A12011.9	A02211.9		
	12.00	0.4724	51	102	A12012.0	A02212.0	A62012.0	A11712.0
	12.10	0.4764	51	102	A12012.1	A02212.1		
	12.20	0.4803	51	102	A12012.2	A02212.2	A62012.2	
	12.50	0.4921	51	102	A12012.5	A02212.5	A62012.5	
1/2	12.70	0.5000	51	102	A1201/2			A1171/2
1/2	12.70	0.5000	60	98		A0221/2		
	12.80	0.5039	51	102			A62012.8	
	13.00	0.5118	51	102	A12013.0	A02213.0	A62013.0	A11713.0
	13.50	0.5315	54	107	A12013.5	A02213.5		
	14.00	0.5512	54	107	A12014.0	A02214.0		
9/16	14.29	0.5626	56	111	A1209/16			
9/16	14.29	0.5626	67	105		A0229/16		
	14.50	0.5709	56	111	A12014.5	A02214.5		
	15.00	0.5906	56	111	A12015.0	A02215.0		
	15.50	0.6102	58	115	A12015.5	A02215.5		
5/8	15.88	0.6252	58	115	A1205/8			
5/8	15.88	0.6252	73	111		A0225/8		
	16.00	0.6299	58	115	A12016.0	A02216.0		
	16.50	0.6496	60	119	A12016.5			
	17.00	0.6693	60	119	A12017.0			
11/16	17.46	0.6874	62	123	A12011/16			
	17.50	0.6890	62	123	A12017.5			
	18.00	0.7087	62	123	A12018.0			
	18.50	0.7283	64	127	A12018.5			
	19.00	0.7480	64	127	A12019.0			
3/4	19.05	0.7500	66	131	A1203/4			
	19.50	0.7677	66	131	A12019.5			
	20.00	0.7874	66	131	A12020.0			
	20.50	0.8071	68	136	A12020.5			
13/16	20.64	0.8126	68	136	A12013/16			
	21.00	0.8268	68	136	A12021.0			
	22.00	0.8661	70	141	A12022.0			
7/8	22.22	0.8748	70	141	A1207/8			
	23.00	0.9055	72	146	A12023.0			
15/16	23.81	0.9374	75	151	A12015/16			
	24.00	0.9449	75	151	A12024.0			
	25.00	0.9843	75	151	A12025.0			

A520

- ADX vrták krátký
- Сверло ADX, укороченное исполнение
- Wiertło typu ADX krótkie
- ADX vrták krátky

A520	▪	1.1	1.2	1.3	1.4	1.5	2.1	2.2	2.3	3.1	3.2	3.3	3.4	4.1	4.2	6.2	6.3	7.2	7.3	7.4	8.2	
		8.3																				
	•	1.6	4.3	5.1	5.2	5.3	6.1	6.4	7.1	8.1												

A520 HSS DIN 1897 2.5XD 130° TiN

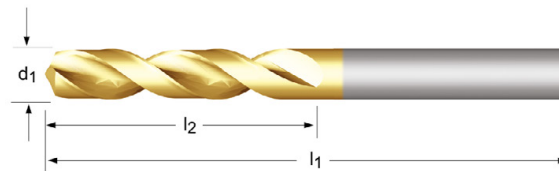

d_1 $\varnothing h_8$ Inch	d_1 $\varnothing h_8$ mm	d_1 decimal Inch	l_2 mm	l_1 mm	A520
1/8	3.00	0.1181	16	46	A5203.0
	3.10	0.1220	18	49	A5203.1
	3.18	0.1252	18	49	A5201/8
	3.20	0.1260	18	49	A5203.2
	3.30	0.1299	18	49	A5203.3
9/64	3.40	0.1339	20	52	A5203.4
	3.50	0.1378	20	52	A5203.5
	3.57	0.1406	20	52	A5209/64
	3.60	0.1417	20	52	A5203.6
	3.70	0.1457	20	52	A5203.7
5/32	3.80	0.1496	22	55	A5203.8
	3.90	0.1535	22	55	A5203.9
	3.97	0.1563	22	55	A5205/32
	4.00	0.1575	22	55	A5204.0
	4.10	0.1614	22	55	A5204.1
11/64	4.20	0.1654	22	55	A5204.2
	4.30	0.1693	24	58	A5204.3
	4.37	0.1720	24	58	A52011/64
	4.40	0.1732	24	58	A5204.4
	4.50	0.1772	24	58	A5204.5
3/16	4.60	0.1811	24	58	A5204.6
	4.70	0.1850	24	58	A5204.7
	4.76	0.1874	26	62	A5203/16
	4.80	0.1890	26	62	A5204.8
	4.90	0.1929	26	62	A5204.9
13/64	5.00	0.1969	26	62	A5205.0
	5.10	0.2008	26	62	A5205.1
	5.16	0.2031	26	62	A52013/64
	5.20	0.2047	26	62	A5205.2
	5.30	0.2087	26	62	A5205.3
7/32	5.40	0.2126	28	66	A5205.4
	5.50	0.2165	28	66	A5205.5
	5.56	0.2189	28	66	A5207/32
	5.60	0.2205	28	66	A5205.6
	5.70	0.2244	28	66	A5205.7
15/64	5.80	0.2283	28	66	A5205.8
	5.90	0.2323	28	66	A5205.9
	5.95	0.2343	28	66	A52015/64

d_1 $\varnothing h_8$ Inch	d_1 $\varnothing h_8$ mm	d_1 decimal Inch	l_2 mm	l_1 mm	A520
	6.00	0.2362	28	66	A5206.0
	6.10	0.2402	31	70	A5206.1
	6.20	0.2441	31	70	A5206.2
	6.30	0.2480	31	70	A5206.3
1/4	6.35	0.2500	31	70	A5201/4
	6.40	0.2520	31	70	A5206.4
	6.50	0.2559	31	70	A5206.5
	6.60	0.2598	31	70	A5206.6
	6.70	0.2638	31	70	A5206.7
17/64	6.75	0.2657	34	74	A52017/64
	6.80	0.2677	34	74	A5206.8
	6.90	0.2717	34	74	A5206.9
	7.00	0.2756	34	74	A5207.0
	7.10	0.2795	34	74	A5207.1
9/32	7.14	0.2811	34	74	A5209/32
	7.20	0.2835	34	74	A5207.2
	7.30	0.2874	34	74	A5207.3
	7.40	0.2913	34	74	A5207.4
	7.50	0.2953	34	74	A5207.5
19/64	7.54	0.2969	37	79	A52019/64
	7.60	0.2992	37	79	A5207.6
	7.70	0.3031	37	79	A5207.7
	7.80	0.3071	37	79	A5207.8
	7.90	0.3110	37	79	A5207.9
5/16	7.94	0.3126	37	79	A5205/16
	8.00	0.3150	37	79	A5208.0
	8.10	0.3189	37	79	A5208.1
	8.20	0.3228	37	79	A5208.2
	8.30	0.3268	37	79	A5208.3
21/64	8.33	0.3280	37	79	A52021/64
	8.40	0.3307	37	79	A5208.4
	8.50	0.3346	37	79	A5208.5
	8.60	0.3386	40	84	A5208.6
	8.70	0.3425	40	84	A5208.7
11/32	8.73	0.3437	40	84	A52011/32
	8.80	0.3465	40	84	A5208.8
	8.90	0.3504	40	84	A5208.9
	9.00	0.3543	40	84	A5209.0
	9.10	0.3583	40	84	A5209.1
23/64	9.13	0.3594	40	84	A52023/64
	9.20	0.3622	40	84	A5209.2
	9.30	0.3661	40	84	A5209.3
	9.40	0.3701	40	84	A5209.4
	9.50	0.3740	40	84	A5209.5
3/8	9.52	0.3748	43	89	A5203/8
	9.60	0.3780	43	89	A5209.6
	9.70	0.3819	43	89	A5209.7
	9.80	0.3858	43	89	A5209.8
	9.90	0.3898	43	89	A5209.9
25/64	9.92	0.3906	43	89	A52025/64
	10.00	0.3937	43	89	A52010.0
	10.10	0.3976	43	89	A52010.1
	10.20	0.4016	43	89	A52010.2
	10.30	0.4055	43	89	A52010.3
13/32	10.32	0.4063	43	89	A52013/32
	10.40	0.4094	43	89	A52010.4
	10.50	0.4134	43	89	A52010.5
	10.60	0.4173	43	89	A52010.6
	10.70	0.4213	47	95	A52010.7
27/64	10.72	0.4220	47	95	A52027/64
	10.80	0.4252	47	95	A52010.8
	10.90	0.4291	47	95	A52010.9
	11.00	0.4331	47	95	A52011.0
	11.10	0.4370	47	95	A52011.1
7/16	11.11	0.4374	47	95	A5207/16
	11.20	0.4409	47	95	A52011.2
	11.30	0.4449	47	95	A52011.3
	11.40	0.4488	47	95	A52011.4
	11.50	0.4528	47	95	A52011.5
29/64	11.51	0.4531	47	95	A52029/64

d_1 $\varnothing h_8$ Inch	d_1 $\varnothing h_8$ mm	d_1 decimal Inch	l_2 mm	l_1 mm	A520
	11.60	0.4567	47	95	A52011.6
	11.70	0.4606	47	95	A52011.7
	11.80	0.4646	47	95	A52011.8
	11.90	0.4685	51	102	A52011.9
15/32	11.91	0.4689	51	102	A52015/32
	12.00	0.4724	51	102	A52012.0
	12.10	0.4764	51	102	A52012.1
	12.20	0.4803	51	102	A52012.2
	12.30	0.4843	51	102	A52012.3
31/64	12.30	0.4843	51	102	A52031/64
	12.40	0.4882	51	102	A52012.4
	12.50	0.4921	51	102	A52012.5
	12.60	0.4961	51	102	A52012.6
	12.70	0.5000	51	102	A52012.7
1/2	12.70	0.5000	51	102	A5201/2
	12.80	0.5039	51	102	A52012.8
	12.90	0.5079	51	102	A52012.9
	13.00	0.5118	51	102	A52013.0

A124

- Navrtávák, naletovaná karbidová špička, 4 fazety
- Сверло ADX с 4-х гранной заточкой и напайной т/с пластиной
- Wiertło krótkie. 4 płaszczyznowe ostrze z wlutowaną płytką węglkową.
- Navrtávák, naletovaná karbidová špička, 4 fazety

Hrot dle DIN 1809
 Согласно DIN 1809
 Chwył zgodnie z DIN 1809
 Hrot podľa DIN 1809

A124	▪	3.1	3.2	3.3	3.4										
	•	1.5	1.6	2.2	2.3	4.1	4.2	4.3	5.1	5.2	5.3	6.2	6.3	6.4	8.2

A124

HSS
HM

DIN
8037

2.5XD

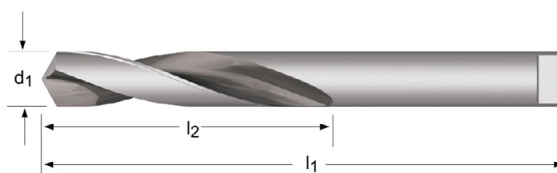

A124



3.00 - 16.00

d ₁ Ø mm	d ₁ decimal Inch	l ₂ mm	l ₁ mm	A124
3.00	0.1181	20	50	A1243.0
3.20	0.1260	25	56	A1243.2
3.50	0.1378	25	56	A1243.5
4.00	0.1575	25	56	A1244.0
4.20	0.1654	28	63	A1244.2
4.50	0.1772	28	63	A1244.5
4.80	0.1890	28	63	A1244.8
5.00	0.1969	28	63	A1245.0
5.20	0.2047	32	71	A1245.2
5.50	0.2165	32	71	A1245.5
5.80	0.2283	32	71	A1245.8
6.00	0.2362	32	71	A1246.0
6.50	0.2559	32	71	A1246.5
6.80	0.2677	40	80	A1246.8
7.00	0.2756	40	80	A1247.0
7.50	0.2953	40	80	A1247.5
8.00	0.3150	40	80	A1248.0
8.50	0.3346	50	90	A1248.5
9.00	0.3543	50	90	A1249.0
9.50	0.3740	50	90	A1249.5
10.00	0.3937	56	100	A12410.0
10.50	0.4134	56	100	A12410.5
11.00	0.4331	56	100	A12411.0
11.50	0.4528	63	112	A12411.5
12.00	0.4724	63	112	A12412.0
13.00	0.5118	63	112	A12413.0
14.00	0.5512	71	125	A12414.0
15.00	0.5906	71	125	A12415.0
16.00	0.6299	80	140	A12416.0

A720

- Mikrovrták
- Микросверло
- Wiertło mikro
- Mikrovrták

A720	▪	1.1	1.2	1.3	1.4	3.1	3.2														
	•	1.5	1.6	2.1	2.2	2.3	3.3	3.4	4.1	4.2	4.3	5.1	5.2	5.3	6.1	6.2	6.3	6.4	7.1	7.2	7.3
		7.4	8.1	8.2																	

A720 HSS-E DIN 1899 2.5XD 118° N



d ₁ Ø mm	d ₁ decimal Inch	l ₂ mm	l ₁ mm	d ₂ Ø mm	A720
0.15	0.0059	1.0	25	1	A720.15
0.16	0.0063	1.4	25	1	A720.16
0.17	0.0067	1.4	25	1	A720.17
0.18	0.0070	1.4	25	1	A720.18
0.20	0.0078	1.8	25	1	A720.2
0.22	0.0087	1.8	25	1	A720.22
0.25	0.0098	2.2	25	1	A720.25
0.27	0.0106	2.2	25	1	A720.27
0.28	0.0110	2.2	25	1	A720.28
0.30	0.0118	2.2	25	1	A720.3
0.35	0.0138	2.8	25	1	A720.35
0.38	0.0150	2.8	25	1	A720.38
0.39	0.0154	3.6	25	1	A720.39
0.40	0.0157	3.6	25	1	A720.4
0.45	0.0177	3.6	25	1	A720.45
0.50	0.0197	4.0	25	1	A720.5
0.55	0.0217	4.5	25	1	A720.55
0.60	0.0236	4.5	25	1	A720.6
0.62	0.0244	5.0	25	1	A720.62
0.65	0.0256	5.0	25	1	A720.65
0.70	0.0276	5.6	25	1	A720.7
0.75	0.0295	5.6	25	1	A720.75
0.80	0.0315	6.3	25	1.5	A720.8
0.85	0.0335	6.3	25	1.5	A720.85
0.90	0.0354	7.1	25	1.5	A720.9
0.95	0.0374	7.1	25	1.5	A720.95
1.00	0.0394	8.0	25	1.5	A720.10
1.05	0.0413	8.0	25	1.5	A720.105
1.10	0.0433	9.0	25	1.5	A720.11
1.20	0.0472	10.0	25	1.5	A720.12
1.30	0.0512	10.0	25	1.5	A720.13
1.40	0.0551	11.2	25	1.5	A720.14

- A920**
- PFX vrták krátky
 - Спиральное сверло PFX, укороченное исполнение
- A921**
- Wiertło typu PFX, krótkie
 - PFX vrták krátky

A920	▪	1.1	1.2	1.3	1.4	1.5	1.6	2.1	2.2	2.3	4.1	4.2	4.3	5.1	5.2	5.3	7.2
	•	3.1	3.2	3.3	3.4	6.1	6.2	6.3	6.4	7.1	7.3	7.4	8.1	8.2			
A921	▪	1.1	1.2	1.3	1.4	1.5	1.6	2.1	2.2	2.3	3.1	3.2	3.3	3.4	7.4		
	•	4.1	4.2	4.3	5.1	5.2	5.3	6.3	6.4								

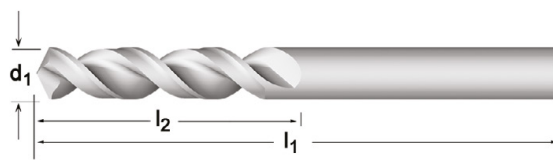
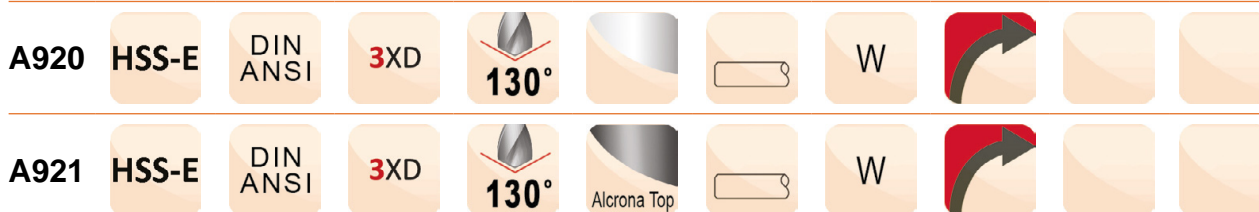

d_1 $\varnothing h_8$ Inch	d_1 $\varnothing h_8$ mm	d_1 decimal Inch	l_2 mm	l_1 mm	A920	A921
	1.00	0.0394	6	26	A9201.0	
	1.10	0.0433	7	28	A9201.1	
3/64	1.19	0.0469	13	35	A9203/64	
	1.20	0.0472	8	30	A9201.2	
	1.25	0.0492	8	30	A9201.25	
	1.30	0.0512	8	30	A9201.3	
	1.35	0.0531	9	32	A9201.35	
	1.40	0.0551	9	32	A9201.4	
	1.50	0.0591	9	32	A9201.5	
	1.55	0.0610	10	34	A9201.55	
1/16	1.59	0.0626	16	41	A9201/16	
	1.60	0.0630	10	34	A9201.6	
	1.70	0.0669	10	34	A9201.7	
	1.75	0.0689	11	36	A9201.75	
	1.80	0.0709	11	36	A9201.8	
	1.90	0.0748	11	36	A9201.9	
5/64	1.98	0.0780	17	43	A9205/64	
	2.00	0.0787	12	38	A9202.0	
	2.10	0.0827	12	38	A9202.1	
	2.15	0.0846	13	40	A9202.15	
	2.20	0.0866	13	40	A9202.2	
	2.30	0.0906	13	40	A9202.3	
	2.35	0.0925	14	43	A9202.35	
3/32	2.38	0.0937	19	41	A9203/32	
	2.40	0.0945	14	43	A9202.4	
	2.50	0.0984	14	43	A9202.5	A9212.5
	2.60	0.1024	14	43	A9202.6	A9212.6
	2.70	0.1063	16	46	A9202.7	A9212.7
7/64	2.78	0.1094	21	46	A9207/64	A9217/64
	2.80	0.1102	16	46	A9202.8	
	2.90	0.1142	16	46	A9202.9	A9212.9
	3.00	0.1181	16	46	A9203.0	A9213.0

d_1 Øh ₈ Inch	d_1 Øh ₈ mm	d_1 decimal Inch	l_2 mm	l_1 mm	A920	A921
1/8	3.10	0.1220	18	49	A9203.1	A9213.1
	3.18	0.1252	22	48	A9201/8	A9211/8
	3.20	0.1260	18	49	A9203.2	A9213.2
	3.30	0.1299	18	49	A9203.3	A9213.3
	3.40	0.1339	20	52	A9203.4	A9213.4
9/64	3.50	0.1378	20	52	A9203.5	A9213.5
	3.57	0.1406	24	49	A9209/64	A9219/64
	3.60	0.1417	20	52	A9203.6	A9213.6
	3.70	0.1457	20	52	A9203.7	A9213.7
	3.80	0.1496	22	55	A9203.8	A9213.8
5/32	3.90	0.1535	22	55	A9203.9	A9213.9
	3.97	0.1563	25	52	A9205/32	A9215/32
	4.00	0.1575	22	55	A9204.0	A9214.0
	4.10	0.1614	22	55	A9204.1	A9214.1
	4.20	0.1654	22	55	A9204.2	A9214.2
11/64	4.30	0.1693	24	58	A9204.3	A9214.3
	4.37	0.1720	27	54	A92011/64	A92111/64
	4.40	0.1732	24	58	A9204.4	A9214.4
	4.50	0.1772	24	58	A9204.5	A9214.5
	4.60	0.1811	24	58	A9204.6	A9214.6
3/16	4.70	0.1850	24	58	A9204.7	A9214.7
	4.76	0.1874	29	56	A9203/16	A9213/16
	4.80	0.1890	26	62	A9204.8	A9214.8
	4.90	0.1929	26	62	A9204.9	A9214.9
	5.00	0.1969	26	62	A9205.0	A9215.0
13/64	5.10	0.2008	26	62	A9205.1	A9215.1
	5.16	0.2031	30	57	A92013/64	A92113/64
	5.20	0.2047	26	62	A9205.2	A9215.2
	5.30	0.2087	26	62	A9205.3	A9215.3
	5.40	0.2126	28	66	A9205.4	A9215.4
7/32	5.50	0.2165	28	66	A9205.5	A9215.5
	5.56	0.2189	32	60	A9207/32	A9217/32
	5.60	0.2205	28	66	A9205.6	A9215.6
	5.70	0.2244	28	66	A9205.7	A9215.7
	5.80	0.2283	28	66	A9205.8	A9215.8
15/64	5.90	0.2323	28	66	A9205.9	A9215.9
	5.95	0.2343	33	62	A92015/64	A92115/64
	6.00	0.2362	28	66	A9206.0	A9216.0
	6.10	0.2402	31	70	A9206.1	A9216.1
	6.20	0.2441	31	70	A9206.2	A9216.2
1/4	6.30	0.2480	31	70	A9206.3	A9216.3
	6.35	0.2500	35	64	A9201/4	A9211/4
	6.40	0.2520	31	70	A9206.4	A9216.4
	6.50	0.2559	31	70	A9206.5	A9216.5
	6.60	0.2598	31	70	A9206.6	A9216.6
17/64	6.70	0.2638	31	70	A9206.7	A9216.7
	6.75	0.2657	37	67	A92017/64	A92117/64
	6.80	0.2677	34	74	A9206.8	A9216.8
	6.90	0.2717	34	74	A9206.9	A9216.9
	7.00	0.2756	34	74	A9207.0	A9217.0
9/32	7.10	0.2795	34	74	A9207.1	A9217.1
	7.14	0.2811	38	68	A9209/32	A9219/32
	7.20	0.2835	34	74	A9207.2	A9217.2
	7.30	0.2874	34	74	A9207.3	A9217.3
	7.40	0.2913	34	74	A9207.4	A9217.4
19/64	7.50	0.2953	34	74	A9207.5	A9217.5
	7.54	0.2969	40	70	A92019/64	A92119/64
	7.60	0.2992	37	79	A9207.6	A9217.6
	7.70	0.3031	37	79	A9207.7	A9217.7
	7.80	0.3071	37	79	A9207.8	A9217.8
5/16	7.90	0.3110	37	79	A9207.9	A9217.9
	7.94	0.3126	41	71	A9205/16	A9215/16
	8.00	0.3150	37	79	A9208.0	A9218.0
	8.10	0.3189	37	79	A9208.1	A9218.1
	8.20	0.3228	37	79	A9208.2	A9218.2
21/64	8.30	0.3268	37	79	A9208.3	A9218.3
	8.33	0.3280	43	75	A92021/64	A92121/64
	8.40	0.3307	37	79	A9208.4	A9218.4
	8.50	0.3346	37	79	A9208.5	A9218.5
	8.60	0.3386	40	84	A9208.6	A9218.6

d_1 $\varnothing h_8$ Inch	d_1 $\varnothing h_8$ mm	d_1 decimal Inch	l_2 mm	l_1 mm	A920	A921
11/32	8.70	0.3425	40	84	A9208.7	A9218.7
	8.73	0.3437	43	76	A92011/32	A92111/32
	8.80	0.3465	40	84	A9208.8	A9218.8
	8.90	0.3504	40	84	A9208.9	A9218.9
	9.00	0.3543	40	84	A9209.0	A9219.0
23/64	9.10	0.3583	40	84	A9209.1	A9219.1
	9.13	0.3594	44	78	A92023/64	A92123/64
	9.20	0.3622	40	84	A9209.2	A9219.2
	9.30	0.3661	40	84	A9209.3	A9219.3
	9.40	0.3701	40	84	A9209.4	A9219.4
3/8	9.50	0.3740	40	84	A9209.5	A9219.5
	9.52	0.3748	46	79	A9203/8	A9213/8
	9.60	0.3780	43	89	A9209.6	A9219.6
	9.70	0.3819	43	89	A9209.7	A9219.7
	9.80	0.3858	43	89	A9209.8	A9219.8
25/64	9.90	0.3898	43	89	A9209.9	A9219.9
	9.92	0.3906	48	83	A92025/64	A92125/64
	10.00	0.3937	43	89	A92010.0	A92110.0
	10.20	0.4016	43	89	A92010.2	A92110.2
	10.30	0.4055	43	89	A92010.3	A92110.3
13/32	10.32	0.4063	49	84	A92013/32	A92113/32
	10.50	0.4134	43	89	A92010.5	A92110.5
	10.72	0.4220	51	86	A92027/64	A92127/64
27/64	10.80	0.4252	47	95	A92010.8	A92110.8
	11.00	0.4331	47	95	A92011.0	A92111.0
	11.11	0.4374	52	87	A9207/16	A9217/16
7/16	11.50	0.4528	47	95	A92011.5	A92111.5
	11.51	0.4531	54	90	A92029/64	A92129/64
	11.80	0.4646	47	95	A92011.8	A92111.8
15/32	11.91	0.4689	54	92	A92015/32	A92115/32
	12.00	0.4724	51	102	A92012.0	A92112.0
	12.20	0.4803	51	102	A92012.2	
31/64	12.30	0.4843	56	94	A92031/64	A92131/64
	12.50	0.4921	51	102	A92012.5	A92112.5
	12.70	0.5000	57	95	A9201/2	A9211/2
1/2	13.00	0.5118	51	102	A92013.0	A92113.0
	13.10	0.5157	60	98	A92033/64	A92133/64
	13.50	0.5315	54	107	A92013.5	A92113.5
33/64	13.89	0.5469	64	102	A92035/64	A92135/64
	14.00	0.5512	54	107	A92014.0	A92114.0
	14.29	0.5626	64	102	A9209/16	A9219/16
9/16	14.50	0.5709	56	111	A92014.5	A92114.5
	14.68	0.5780	67	105	A92037/64	A92137/64
	14.75	0.5807	56	111	A92014.75	A92114.75
37/64	15.00	0.5906	56	111	A92015.0	A92115.0
	15.08	0.5937	67	105	A92019/32	A92119/32
	15.48	0.6094	70	108	A92039/64	A92139/64
5/8	15.50	0.6102	58	115	A92015.5	A92115.5
	15.88	0.6252	70	108	A9205/8	A9215/8
	16.00	0.6299	58	115	A92016.0	A92116.0
41/64	16.27	0.6406	73	114	A92041/64	
	16.50	0.6496	60	119	A92016.5	
	16.67	0.6563	73	114	A92021/32	
21/32	16.75	0.6594	60	119	A92016.75	
	17.00	0.6693	60	119	A92017.0	
	17.07	0.6720	73	117	A92043/64	
43/64	17.46	0.6874	73	117	A92011/16	
	17.50	0.6890	62	123	A92017.5	
	17.86	0.7031	76	121	A92045/64	
45/64	18.00	0.7087	62	123	A92018.0	
	18.26	0.7189	76	121	A92023/32	
	18.50	0.7283	64	127	A92018.5	
23/32	18.65	0.7343	79	127	A92047/64	
	19.00	0.7480	64	127	A92019.0	
	19.05	0.7500	79	127	A9203/4	
49/64	19.45	0.7657	83	130	A92049/64	
	19.50	0.7677	66	131	A92019.5	
	19.84	0.7811	83	130	A92025/32	
25/32	20.00	0.7874	66	131	A92020.0	

A002

- 002 vrták základní délka, dělený břit
- Универсальное сверло с подточкой перемычки
- 002 wiertło ogólnego stosowania
- 002 vrták základná dĺžka, delený břit

Broušený povrch pod 2.0mm, podbroušená povlakovaná špička TiN od 2,0mm a výše
 Шлифованные менее 2.0 мм, более 2.0 мм покрытие TiN и подточка вершины
 Niepokrywane poniżej 2,0mm, z pokryciem TiN od 2,0mm i wyżej
 Brúsený povrch pod 2.0mm, podbrúsená povlakovaná špička TiN od 2,0mm a viac

A002S

- 002 vrták základní délka, dělený břit - balení v pytlíku
- Универсальное сверло с подточкой перемычки - Блистерная упаковка
- 002 wiertło ogólnego stosowania-pakowane pojedynczo
- 002 vrták základná dĺžka, delený břit - balenie vo vrecku

povlakovaná špička TiN
 TiN покрытие
 z pokryciem TiN
 TiN povlakovaná špička

A100

- Vrták zákl. délka
- Спиральное сверло, короткое исполнение
- Wiertło ogólnego stosowania
- Vrták základná dĺžka

Broušený povrch pod 1,0 mm, 3/64", N60
 Менее 1,0 мм, 3/64", N60 полированные
 Niepokrywane poniżej 1,0 mm, 3/64", N60
 základná pod 1,0 mm, 3/64", N60

A101

- Vrták zákl. délka
- Спиральное сверло, короткое исполнение
- Wiertło ogólnego stosowania
- Vrták základná dĺžka

Broušený povrch pod 3,0 mm
 Менее 3,0 мм полированные
 Niepokrywane poniżej 3 mm
 Brúsený povrch pod 3,0mm

A002; A002S	▪	1.1	1.2	1.3	1.4	3.1	3.2	7.1	7.2	8.1	8.2								
	•	1.5	1.6	2.1	2.2	2.3	3.3	3.4	4.1	4.2	4.3	5.1	5.2	5.3	6.1	6.2	6.3	6.4	7.3
		9.1																	
A100; A101	▪	1.1	1.2	1.3	1.4	3.1	3.2												
	•	1.5	1.6	2.1	2.2	2.3	3.3	3.4	4.1	4.2	4.3	5.1	5.2	5.3	6.1	6.2	6.3	6.4	7.1
		7.4	8.1	8.2	8.3	9.1													

A002	HSS	DIN 338	4XD	118°	TiN		N												
	126	128	127	125	129	336	337	338	333	334	335								
A002S	HSS	DIN 338	4XD	118°	TiN		N												
A100	HSS	DIN 338	4XD	118°	ST		N												
									132	133	130								
A101	HSS	DIN 338	4XD	118°	ST		N												

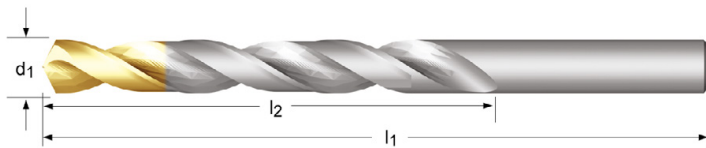

d_1 $\varnothing h_8$ "/Nr./letter	d_1 $\varnothing h_8$ mm	d_1 decimal Inch	l_2 mm	l_1 mm	A002	A002S	A100	A101
	0.20	0.0079	2.5	19			A100.2	
	0.25	0.0098	3	19			A100.25	
	0.30	0.0118	3	19			A100.3	
	0.32	0.0126	4	19			A100.32	
80	0.34	0.0134	4	19			A100N80	
	0.35	0.0138	4	19			A100.35	
79	0.37	0.0146	4	19			A100N79	
	0.38	0.0150	4	19			A100.38	
1/64	0.40	0.0157	5	20			A1001/64	
	0.40	0.0157	5	20			A100.4	
78	0.41	0.0161	5	20			A100N78	
	0.42	0.0165	5	20			A100.42	
	0.45	0.0177	5	20			A100.45	
77	0.46	0.0181	5	20			A100N77	
	0.48	0.0189	5	20			A100.48	
	0.50	0.0197	6	22			A100.5	
76	0.51	0.0201	6	22			A100N76	
	0.52	0.0205	6	22			A100.52	
75	0.53	0.0209	6	22			A100N75	
	0.55	0.0217	7	24			A100.55	
74	0.57	0.0224	7	24			A100N74	
	0.58	0.0228	7	24			A100.58	
	0.60	0.0236	7	24			A100.6	
73	0.61	0.0240	8	26			A100N73	
	0.62	0.0244	8	26			A100.62	
72	0.64	0.0252	8	26			A100N72	
	0.65	0.0256	8	26			A100.65	
71	0.66	0.0260	8	26			A100N71	
	0.68	0.0268	9	28			A100.68	
	0.70	0.0276	9	28			A100.7	
70	0.71	0.0280	9	28			A100N70	
	0.72	0.0283	9	28			A100.72	
69	0.74	0.0291	9	28			A100N69	
	0.75	0.0295	9	28			A100.75	
68	0.79	0.0311	10	30			A100N68	
	0.78	0.0307	10	30			A100.78	
1/32	0.79	0.0311	10	30			A1001/32	
	0.80	0.0315	10	30			A100.8	
67	0.81	0.0319	10	30			A100N67	
	0.82	0.0323	10	30			A100.82	
66	0.84	0.0331	10	30			A100N66	
	0.85	0.0335	10	30			A100.85	
	0.88	0.0346	11	32			A100.88	
65	0.89	0.0350	11	32			A100N65	
	0.90	0.0354	11	32			A100.9	
64	0.91	0.0358	11	32			A100N64	
	0.92	0.0362	11	32			A100.92	
63	0.94	0.0370	11	32			A100N63	

d_1 $\varnothing h_8$ "/Nr./letter	d_1 $\varnothing h_8$ mm	d_1 decimal Inch	l_2 mm	l_1 mm	A002	A002S	A100	A101
	0.95	0.0374	11	32			A100.95	
62	0.97	0.0382	12	34			A100N62	
	0.98	0.0386	12	34			A100.98	
61	0.99	0.0390	12	34			A100N61	
	1.00	0.0394	12	34	A0021.0		A1001.0	A1011.0
60	1.02	0.0402	12	34			A100N60	
59	1.04	0.0409	12	34			A100N59	
	1.05	0.0413	12	34			A1001.05	
58	1.07	0.0421	14	36			A100N58	
57	1.09	0.0429	14	36			A100N57	
	1.10	0.0433	14	36	A0021.1		A1001.1	A1011.1
	1.15	0.0453	14	36			A1001.15	
56	1.18	0.0465	14	36			A100N56	
3/64	1.19	0.0469	16	38	A0023/64		A1003/64	
	1.20	0.0472	16	38	A0021.2		A1001.2	A1011.2
	1.25	0.0492	16	38			A1001.25	A1011.25
	1.30	0.0512	16	38	A0021.3		A1001.3	A1011.3
55	1.32	0.0520	16	38			A100N55	
	1.35	0.0531	18	40			A1001.35	
	1.40	0.0551	18	40	A0021.4		A1001.4	A1011.4
54	1.40	0.0551	18	40			A100N54	
	1.45	0.0571	18	40			A1001.45	
	1.50	0.0591	18	40	A0021.5		A1001.5	A1011.5
53	1.51	0.0594	20	43			A100N53	
	1.55	0.0610	20	43			A1001.55	
1/16	1.59	0.0626	20	43	A0021/16		A1001/16	
	1.60	0.0630	20	43	A0021.6		A1001.6	A1011.6
52	1.61	0.0634	20	43			A100N52	
	1.65	0.0650	20	43			A1001.65	
	1.70	0.0669	20	43	A0021.7		A1001.7	A1011.7
51	1.70	0.0669	22	46			A100N51	
	1.75	0.0689	22	46			A1001.75	
50	1.78	0.0701	22	46			A100N50	
	1.80	0.0709	22	46	A0021.8		A1001.8	A1011.8
	1.85	0.0728	22	46			A1001.85	
49	1.85	0.0728	22	46			A100N49	
	1.90	0.0748	22	46	A0021.9		A1001.9	A1011.9
48	1.93	0.0760	24	49			A100N48	
	1.95	0.0768	24	49			A1001.95	
5/64	1.98	0.0780	24	49	A0025/64		A1005/64	
47	1.99	0.0783	24	49			A100N47	
	2.00	0.0787	24	49	A0022.0	A002S2.0 ²⁾	A1002.0	A1012.0
	2.05	0.0807	24	49			A1002.05	
46	2.06	0.0811	24	49			A100N46	
45	2.08	0.0819	24	49			A100N45	
	2.10	0.0827	24	49	A0022.1		A1002.1	A1012.1
	2.15	0.0846	27	53			A1002.15	
44	2.18	0.0858	27	53			A100N44	
	2.20	0.0866	27	53	A0022.2		A1002.2	A1012.2
	2.25	0.0886	27	53			A1002.25	
43	2.26	0.0890	27	53			A100N43	
	2.30	0.0906	27	53	A0022.3		A1002.3	A1012.3
	2.35	0.0925	27	53			A1002.35	
42	2.38	0.0937	30	57			A100N42	
3/32	2.38	0.0937	30	57	A0023/32		A1003/32	
	2.40	0.0945	30	57	A0022.4		A1002.4	A1012.4
41	2.44	0.0961	30	57			A100N41	
	2.45	0.0965	30	57			A1002.45	
40	2.49	0.0980	30	57			A100N40	
	2.50	0.0984	30	57	A0022.5	A002S2.5 ²⁾	A1002.5	A1012.5
39	2.53	0.0996	30	57			A100N39	
	2.55	0.1004	30	57			A1002.55	
38	2.58	0.1016	30	57			A100N38	
	2.60	0.1024	30	57	A0022.6		A1002.6	A1012.6
37	2.64	0.1039	30	57			A100N37	
	2.65	0.1043	30	57			A1002.65	
	2.70	0.1063	33	61	A0022.7		A1002.7	A1012.7
36	2.71	0.1067	33	61			A100N36	

d ₁ Øh ₈ "/Nr./letter	d ₁ Øh ₈ mm	d ₁ decimal Inch	l ₂ mm	l ₁ mm	A002	A002S	A100	A101
	2.75	0.1083	33	61			A1002.75	
7/64	2.78	0.1094	33	61	A0027/64		A1007/64	
35	2.79	0.1098	33	61			A100N35	
	2.80	0.1102	33	61	A0022.8		A1002.8	A1012.8
34	2.82	0.1110	33	61			A100N34	
	2.85	0.1122	33	61			A1002.85	
33	2.87	0.1130	33	61			A100N33	
	2.90	0.1142	33	61	A0022.9		A1002.9	A1012.9
	2.95	0.1161	33	61			A1002.95	
32	2.95	0.1161	33	61			A100N32	
	3.00	0.1181	33	61	A0023.0	A002S3.0 ²⁾	A1003.0	A1013.0
31	3.05	0.1201	36	65			A100N31	
	3.10	0.1220	36	65	A0023.1		A1003.1	
	3.15	0.1240	36	65			A1003.15	
1/8	3.18	0.1252	36	65	A0021/8	A002S1/8 ²⁾	A1001/8	
	3.20	0.1260	36	65	A0023.2	A002S3.2 ²⁾	A1003.2	A1013.2
	3.25	0.1280	36	65	A0023.25		A1003.25	
30	3.26	0.1283	36	65			A100N30	
	3.30	0.1299	36	65	A0023.3	A002S3.3 ²⁾	A1003.3	A1013.3
	3.40	0.1339	39	70	A0023.4		A1003.4	
29	3.45	0.1358	39	70			A100N29	
	3.50	0.1378	39	70	A0023.5	A002S3.5 ²⁾	A1003.5	A1013.5
28	3.57	0.1406	39	70			A100N28	
9/64	3.57	0.1406	39	70	A0029/64		A1009/64	
	3.60	0.1417	39	70	A0023.6		A1003.6	
27	3.66	0.1441	39	70			A100N27	
	3.70	0.1457	39	70	A0023.7		A1003.7	
26	3.73	0.1469	39	70			A100N26	
	3.75	0.1476	39	70			A1003.75	
	3.80	0.1496	43	75	A0023.8		A1003.8	A1013.8
25	3.80	0.1496	43	75			A100N25	
24	3.86	0.1520	43	75			A100N24	
	3.90	0.1535	43	75	A0023.9		A1003.9	
23	3.91	0.1539	43	75			A100N23	
5/32	3.97	0.1563	43	75	A0025/32	A002S5/32 ²⁾	A1005/32	
22	3.99	0.1571	43	75			A100N22	
	4.00	0.1575	43	75	A0024.0	A002S4.0 ²⁾	A1004.0	A1014.0
21	4.04	0.1591	43	75			A100N21	
20	4.09	0.1610	43	75			A100N20	
	4.10	0.1614	43	75	A0024.1	A002S4.1 ²⁾	A1004.1	
	4.20	0.1654	43	75	A0024.2	A002S4.2 ²⁾	A1004.2	A1014.2
19	4.22	0.1661	43	75			A100N19	
	4.25	0.1673	43	75			A1004.25	
	4.30	0.1693	47	80	A0024.3		A1004.3	
18	4.31	0.1697	47	80			A100N18	
11/64	4.37	0.1720	47	80	A00211/64		A10011/64	
17	4.39	0.1728	47	80			A100N17	
	4.40	0.1732	47	80	A0024.4		A1004.4	
	4.50	0.1772	47	80	A0024.5	A002S4.5 ²⁾	A1004.5	A1014.5
16	4.50	0.1772	47	80			A100N16	
15	4.57	0.1799	47	80			A100N15	
	4.60	0.1811	47	80	A0024.6		A1004.6	
14	4.62	0.1819	47	80			A100N14	
	4.70	0.1850	47	80	A0024.7		A1004.7	
13	4.70	0.1850	47	80			A100N13	
	4.75	0.1870	47	80			A1004.75	
3/16	4.76	0.1874	52	86	A0023/16	A002S3/16 ²⁾	A1003/16	
	4.80	0.1890	52	86	A0024.8		A1004.8	A1014.8
12	4.80	0.1890	52	86			A100N12	
11	4.85	0.1909	52	86			A100N11	
	4.90	0.1929	52	86	A0024.9		A1004.9	
10	4.92	0.1937	52	86			A100N10	
9	4.98	0.1961	52	86			A100N9	
	5.00	0.1969	52	86	A0025.0	A002S5.0 ²⁾	A1005.0	A1015.0
8	5.06	0.1992	52	86			A100N8	
	5.10	0.2008	52	86	A0025.1		A1005.1	A1015.1
7	5.11	0.2012	52	86			A100N7	
13/64	5.16	0.2031	52	86	A00213/64	A002S13/64	A10013/64	

d ₁ Øh ₈ "/Nr./letter	d ₁ Øh ₈ mm	d ₁ decimal Inch	l ₂ mm	l ₁ mm	A002	A002S	A100	A101	
6	5.18	0.2039	52	86			A100N6		
	5.20	0.2047	52	86	A0025.2		A1005.2	A1015.2	
5	5.22	0.2055	52	86			A100N5		
	5.25	0.2067	52	86			A1005.25		
	5.30	0.2087	52	86	A0025.3		A1005.3		
4	5.31	0.2091	57	93			A100N4		
	5.40	0.2126	57	93	A0025.4		A1005.4		
3	5.41	0.2130	57	93			A100N3		
	5.50	0.2165	57	93	A0025.5	A002S5.5	A1005.5	A1015.5	
7/32	5.56	0.2189	57	93	A0027/32	A002S7/32	A1007/32		
	5.60	0.2205	57	93	A0025.6		A1005.6		
2	5.61	0.2209	57	93			A100N2		
	5.70	0.2244	57	93	A0025.7		A1005.7		
1	5.75	0.2264	57	93			A1005.75		
	5.79	0.2280	57	93			A100N1		
	5.80	0.2283	57	93	A0025.8		A1005.8		
A	5.90	0.2323	57	93	A0025.9		A1005.9		
	5.94	0.2339	57	93			A100A		
	5.95	0.2343	57	93	A00215/64		A10015/64		
15/64	6.00	0.2362	57	93	A0026.0	A002S6.0	A1006.0	A1016.0	
	6.03	0.2374	63	101			A100B		
B	6.10	0.2402	63	101	A0026.1		A1006.1		
	6.15	0.2421	63	101			A100C		
C	6.20	0.2441	63	101	A0026.2		A1006.2		
	6.25	0.2461	63	101			A1006.25		
	6.25	0.2461	63	101			A100D		
D	6.30	0.2480	63	101	A0026.3		A1006.3		
	6.35	0.2500	63	101	A0021/4	A002S1/4	A1001/4		
1/4	6.35	0.2500	63	101			A100E		
	6.40	0.2520	63	101	A0026.4		A1006.4		
E	6.50	0.2559	63	101	A0026.5	A002S6.5	A1006.5	A1016.5	
	6.53	0.2571	63	101			A100F		
	6.60	0.2598	63	101	A0026.6		A1006.6		
G	6.63	0.2610	63	101			A100G		
	6.70	0.2638	63	101	A0026.7		A1006.7		
17/64	6.75	0.2657	69	109	A00217/64	A002S17/64	A10017/64		
	6.75	0.2657	69	109			A1006.75		
H	6.76	0.2661	69	109			A100H		
	6.80	0.2677	69	109	A0026.8	A002S6.8	A1006.8		
	6.90	0.2717	69	109	A0026.9		A1006.9		
I	6.91	0.2720	69	109			A100I		
	7.00	0.2756	69	109	A0027.0	A002S7.0	A1007.0	A1017.0	
J	7.04	0.2772	69	109			A100J		
	7.10	0.2795	69	109	A0027.1		A1007.1		
K	7.14	0.2811	69	109			A100K		
	7.14	0.2811	69	109	A0029/32		A1009/32		
9/32	7.20	0.2835	69	109	A0027.2		A1007.2		
	7.25	0.2854	69	109			A1007.25		
	7.30	0.2874	69	109	A0027.3		A1007.3		
	7.37	0.2902	69	109			A100L		
L	7.40	0.2913	69	109	A0027.4		A1007.4		
	7.49	0.2949	69	109			A100M		
M	7.50	0.2953	69	109	A0027.5	A002S7.5	A1007.5	A1017.5	
	7.54	0.2969	75	117	A00219/64		A10019/64		
	7.60	0.2992	75	117	A0027.6		A1007.6		
N	7.67	0.3020	75	117			A100N		
	7.70	0.3031	75	117	A0027.7		A1007.7		
	7.75	0.3051	75	117			A1007.75		
	7.80	0.3071	75	117	A0027.8		A1007.8		
	7.90	0.3110	75	117	A0027.9		A1007.9		
	5/16	7.94	0.3126	75	117	A0025/16	A002S5/16	A1005/16	
	8.00	0.3150	75	117	A0028.0	A002S8.0	A1008.0	A1018.0	
O	8.03	0.3161	75	117			A100O		
	8.10	0.3189	75	117	A0028.1		A1008.1		
	8.20	0.3228	75	117	A0028.2	A002S8.2	A1008.2		
P	8.20	0.3228	75	117			A100P		
	8.25	0.3248	75	117			A1008.25		
	8.30	0.3268	75	117	A0028.3		A1008.3		
21/64	8.33	0.3280	75	117	A00221/64		A10021/64		
	8.40	0.3307	75	117	A0028.4		A1008.4		

d ₁ Øh ₈ "/Nr./letter	d ₁ Øh ₈ mm	d ₁ decimal Inch	l ₂ mm	l ₁ mm	A002	A002S	A100	A101
Q	8.43	0.3319	75	117			A100Q	
	8.50	0.3346	75	117	A0028.5	A002S8.5	A1008.5	A1018.5
	8.60	0.3386	81	125	A0028.6		A1008.6	
R	8.61	0.3390	81	125			A100R	
	8.70	0.3425	81	125	A0028.7		A1008.7	
11/32	8.73	0.3437	81	125	A00211/32		A10011/32	
	8.75	0.3445	81	125			A1008.75	
	8.80	0.3465	81	125	A0028.8		A1008.8	
S	8.84	0.3480	81	125			A100S	
	8.90	0.3504	81	125	A0028.9		A1008.9	
	9.00	0.3543	81	125	A0029.0	A002S9.0	A1009.0	A1019.0
T	9.09	0.3579	81	125			A100T	
	9.10	0.3583	81	125	A0029.1		A1009.1	
23/64	9.13	0.3594	81	125	A00223/64		A10023/64	
	9.20	0.3622	81	125	A0029.2		A1009.2	
	9.25	0.3642	81	125			A1009.25	
	9.30	0.3661	81	125	A0029.3		A1009.3	
U	9.35	0.3681	81	125			A100U	
	9.40	0.3701	81	125	A0029.4		A1009.4	
	9.50	0.3740	81	125	A0029.5	A002S9.5	A1009.5	
3/8	9.52	0.3748	87	133	A0023/8	A002S3/8	A1003/8	
V	9.58	0.3772	87	133			A100V	
	9.60	0.3780	87	133	A0029.6		A1009.6	
	9.70	0.3819	87	133	A0029.7		A1009.7	
	9.75	0.3839	87	133			A1009.75	
	9.80	0.3858	87	133	A0029.8		A1009.8	
W	9.80	0.3858	87	133			A100W	
	9.90	0.3898	87	133	A0029.9		A1009.9	
25/64	9.92	0.3906	87	133	A00225/64		A10025/64	
	10.00	0.3937	87	133	A00210.0	A002S10.0	A10010.0	A10110.0
X	10.08	0.3969	87	133			A100X	
	10.10	0.3976	87	133	A00210.1		A10010.1	
	10.20	0.4016	87	133	A00210.2	A002S10.2	A10010.2	
	10.25	0.4035	87	133			A10010.25	
Y	10.26	0.4039	87	133			A100Y	
	10.30	0.4055	87	133	A00210.3		A10010.3	
13/32	10.32	0.4063	87	133	A00213/32		A10013/32	
	10.40	0.4094	87	133	A00210.4		A10010.4	
Z	10.49	0.4130	87	133			A100Z	
	10.50	0.4134	87	133	A00210.5	A002S10.5	A10010.5	
	10.60	0.4173	87	133	A00210.6		A10010.6	
	10.70	0.4213	94	142	A00210.7		A10010.7	
27/64	10.72	0.4220	94	142	A00227/64		A10027/64	
	10.75	0.4232	94	142			A10010.75	
	10.80	0.4252	94	142	A00210.8		A10010.8	
	10.90	0.4291	94	142	A00210.9		A10010.9	
	11.00	0.4331	94	142	A00211.0	A002S11.0	A10011.0	A10111.0
	11.10	0.4370	94	142	A00211.1		A10011.1	
7/16	11.11	0.4374	94	142	A0027/16		A1007/16	
	11.20	0.4409	94	142	A00211.2		A10011.2	
	11.25	0.4429	94	142			A10011.25	
	11.30	0.4449	94	142	A00211.3		A10011.3	
	11.40	0.4488	94	142	A00211.4		A10011.4	
	11.50	0.4528	94	142	A00211.5	A002S11.5	A10011.5	
29/64	11.51	0.4531	94	142	A00229/64		A10029/64	
	11.60	0.4567	94	142	A00211.6		A10011.6	
	11.70	0.4606	94	142	A00211.7		A10011.7	
	11.75	0.4626	94	142			A10011.75	
	11.80	0.4646	94	142	A00211.8		A10011.8	
	11.90	0.4685	101	151	A00211.9		A10011.9	
15/32	11.91	0.4689	101	151	A00215/32		A10015/32	
	12.00	0.4724	101	151	A00212.0	A002S12.0	A10012.0	A10112.0
	12.10	0.4764	101	151	A00212.1		A10012.1	
	12.20	0.4803	101	151	A00212.2		A10012.2	
	12.25	0.4823	101	151			A10012.25	
	12.30	0.4843	101	151	A00212.3		A10012.3	
31/64	12.30	0.4843	101	151	A00231/64		A10031/64	
	12.40	0.4882	101	151	A00212.4		A10012.4	
	12.50	0.4921	101	151	A00212.5	A002S12.5	A10012.5	
	12.60	0.4961	101	151	A00212.6		A10012.6	

d_1 $\varnothing h_8$ "/Nr./letter	d_1 $\varnothing h_8$ mm	d_1 decimal Inch	l_2 mm	l_1 mm	A002	A002S	A100	A101	
1/2	12.70	0.5000	101	151	A00212.7		A10012.7		
	12.70	0.5000	101	151	A0021/2	A002S1/2	A1001/2		
	12.75	0.5020	101	151			A10012.75		
	12.80	0.5039	101	151	A00212.8		A10012.8		
33/64	12.90	0.5079	101	151	A00212.9		A10012.9		
	13.00	0.5118	101	151	A00213.0	A002S13.0	A10013.0		
	13.10	0.5157	101	151	A00233/64		A10033/64		
	13.10	0.5157	101	151	A00213.1		A10013.1		
	13.20	0.5197	101	151	A00213.2		A10013.2		
	13.25	0.5217	108	160	A00213.25		A10013.25		
	13.30	0.5236	108	160	A00213.3		A10013.3		
	13.40	0.5276	108	160	A00213.4		A10013.4		
	17/32	13.49	0.5311	108	160	A00217/32		A10017/32	
		13.50	0.5315	108	160	A00213.5		A10013.5	
35/64	13.60	0.5354	108	160	A00213.6		A10013.6		
	13.70	0.5394	108	160	A00213.7		A10013.7		
	13.75	0.5413	108	160	A00213.75		A10013.75		
	13.80	0.5433	108	160	A00213.8		A10013.8		
	13.89	0.5469	108	160	A00235/64		A10035/64		
	13.90	0.5472	108	160	A00213.9		A10013.9		
	14.00	0.5512	108	160	A00214.0		A10014.0		
	14.25	0.5610	114	169	A00214.25		A10014.25		
	9/16	14.29	0.5626	114	169	A0029/16		A1009/16	
		14.50	0.5709	114	169	A00214.5		A10014.5	
37/64	14.68	0.5780	114	169	A00237/64		A10037/64		
19/32	14.75	0.5807	114	169	A00214.75		A10014.75		
	15.00	0.5906	114	169	A00215.0		A10015.0		
	15.08	0.5937	120	178	A00219/32		A10019/32		
	15.25	0.6004	120	178	A00215.25		A10015.25		
39/64	15.48	0.6094	120	178	A00239/64		A10039/64		
5/8	15.50	0.6102	120	178	A00215.5		A10015.5		
	15.75	0.6201	120	178	A00215.75		A10015.75		
	15.88	0.6252	120	178	A0025/8		A1005/8		
	16.00	0.6299	120	178	A00216.0		A10016.0		
41/64	16.27	0.6406	125	184		A10041/64			
21/32	16.50	0.6496	125	184		A10016.5			
	16.67	0.6563	125	184		A10021/32			
43/64	17.00	0.6693	125	184		A10017.0			
	17.07	0.6720	130	191		A10043/64			
11/16	17.46	0.6874	130	191		A10011/16			
	17.50	0.6890	130	191		A10017.5			
	18.00	0.7087	130	191		A10018.0			
	18.50	0.7283	135	198		A10018.5			
	19.00	0.7480	135	198		A10019.0			
	19.50	0.7677	140	205		A10019.5			
	20.00	0.7874	140	205		A10020.0			

A108

- Vrták zákl. délka
- Спиральное сверло, короткое исполнение
- Wiertło ogólnego stosowania
- Vrták základná dĺžka

Bez příčného ostří od 1,6mm, 1/16" a větší
 Более 1,6 мм, 1/16" подточка вершины
 Ostrze dzielone Split Point 1,6mm, 1/16" i powyżej
 Bez priečného ostria od 1.6mm, 1/16" a väčší

A147

- Vrták zákl. délka
- Спиральное сверло, короткое исполнение
- Wiertło ogólnego stosowania
- Vrták základná dĺžka

A777

- Vrták zákl. délka
- Спиральное сверло, короткое исполнение
- Wiertło ogólnego stosowania
- Vrták základná dĺžka

4 fasetkový vrchol až do 1.4 mm
 Стандартная заточка до 1,4 мм
 4 Plaszczyznowe ostrze do 1.4mm
 4 fazetkový vrchol až do 1.4 mm

A108	▪	2.2	2.3	4.1	4.2																	
	•	1.1	1.2	1.3	1.4	1.5	1.6	2.1	3.1	3.2	3.3	3.4	4.3	5.1	5.2	5.3	6.1	6.2	6.3	6.4	7.1	
		7.2	7.3	7.4	8.1	8.2	8.3	9.1														
A147	▪	2.1	2.2	2.3	4.1	4.2	5.1															
	•	1.1	1.2	1.3	1.4	1.5	1.6	2.4	3.1	3.2	3.3	3.4	4.3	5.2	5.3	6.1	6.2	6.3	6.4	7.1	7.2	
		7.3	7.4	8.1	8.2	8.3	9.1															
A777	▪	1.5	1.6	3.4	4.1	4.2	4.3	5.2														
	•	1.1	1.2	1.3	1.4	2.1	2.2	2.3	3.1	3.2	3.3	5.1	5.3	6.1	6.2	6.3	6.4	7.1	7.2	7.3	7.4	
		9.1																				

A108	HSS	DIN 338	4XD	135°	ST		W			A188 134	L114 334
A147	HSS-E	DIN 338	4XD	130°			VA				
A777	HSS-E	DIN 338	4XD	135°	Bronze		N		NAS 907J	A295 135	

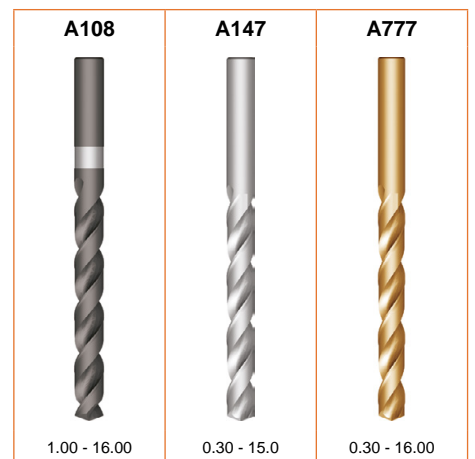
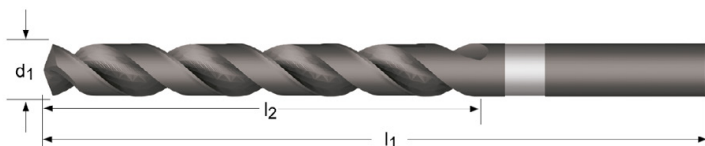

d_1 $\varnothing h_8$ Inch	d_1 $\varnothing h_8$ mm	d_1 decimal Inch	l_2 mm	l_1 mm	A108	A147	A777
	0.30	0.0118	3	19		A147.3	A777.3
	0.35	0.0138	4	19			A777.35
	0.40	0.0157	5	20		A147.4	A777.4
	0.45	0.0177	5	20			A777.45
	0.50	0.0197	6	22		A147.5	A777.5
	0.55	0.0217	7	24			A777.55

d_1 \varnothing_{h_8} Inch	d_1 \varnothing_{h_8} mm	d_1 decimal Inch	l_2 mm	l_1 mm	A108	A147	A777
	0.60	0.0236	7	24		A147.6	A777.6
	0.65	0.0256	8	26			A777.65
	0.70	0.0276	9	28		A147.7	A777.7
	0.80	0.0315	10	30		A147.8	A777.8
	0.90	0.0354	11	32		A147.9	A777.9
	0.95	0.0374	11	32			A777.95
	1.00	0.0394	12	34	A1081.0	A1471.0	A7771.0
	1.10	0.0433	14	36	A1081.1	A1471.1	A7771.1
	1.20	0.0472	16	38	A1081.2	A1471.2	A7771.2
	1.30	0.0512	16	38	A1081.3	A1471.3	A7771.3
	1.40	0.0551	18	40	A1081.4	A1471.4	A7771.4
	1.50	0.0591	18	40	A1081.5	A1471.5	A7771.5
1/16	1.59	0.0626	20	43	A1081/16	A1471/16	A7771/16
	1.60	0.0630	20	43	A1081.6	A1471.6	A7771.6
	1.70	0.0669	20	43	A1081.7	A1471.7	A7771.7
	1.80	0.0709	22	46	A1081.8	A1471.8	A7771.8
	1.90	0.0748	22	46	A1081.9	A1471.9	A7771.9
5/64	1.98	0.0780	24	49	A1085/64		A7775/64
	2.00	0.0787	24	49	A1082.0	A1472.0	A7772.0
	2.10	0.0827	24	49	A1082.1	A1472.1	A7772.1
	2.20	0.0866	27	53	A1082.2	A1472.2	A7772.2
	2.30	0.0906	27	53	A1082.3	A1472.3	A7772.3
3/32	2.38	0.0937	30	57	A1083/32	A1473/32	A7773/32
	2.40	0.0945	30	57	A1082.4	A1472.4	A7772.4
	2.50	0.0984	30	57	A1082.5	A1472.5	A7772.5
	2.60	0.1024	30	57	A1082.6	A1472.6	A7772.6
	2.70	0.1063	33	61	A1082.7	A1472.7	A7772.7
7/64	2.78	0.1094	33	61	A1087/64		A7777/64
	2.80	0.1102	33	61	A1082.8	A1472.8	A7772.8
	2.90	0.1142	33	61	A1082.9	A1472.9	A7772.9
	3.00	0.1181	33	61	A1083.0	A1473.0	A7773.0
	3.10	0.1220	36	65	A1083.1	A1473.1	A7773.1
1/8	3.18	0.1252	36	65	A1081/8	A1471/8	A7771/8
	3.20	0.1260	36	65	A1083.2	A1473.2	A7773.2
	3.30	0.1299	36	65	A1083.3	A1473.3	A7773.3
	3.40	0.1339	39	70	A1083.4	A1473.4	A7773.4
	3.50	0.1378	39	70	A1083.5	A1473.5	A7773.5
9/64	3.57	0.1406	39	70	A1089/64		A7779/64
	3.60	0.1417	39	70	A1083.6	A1473.6	A7773.6
	3.70	0.1457	39	70	A1083.7	A1473.7	A7773.7
	3.80	0.1496	43	75	A1083.8	A1473.8	A7773.8
	3.90	0.1535	43	75	A1083.9	A1473.9	A7773.9
5/32	3.97	0.1563	43	75	A1085/32	A1475/32	A7775/32
	4.00	0.1575	43	75	A1084.0	A1474.0	A7774.0
	4.10	0.1614	43	75	A1084.1	A1474.1	A7774.1
	4.20	0.1654	43	75	A1084.2	A1474.2	A7774.2
	4.30	0.1693	47	80	A1084.3	A1474.3	A7774.3
11/64	4.37	0.1720	47	80	A10811/64		A77711/64
	4.40	0.1732	47	80	A1084.4	A1474.4	A7774.4
	4.50	0.1772	47	80	A1084.5	A1474.5	A7774.5
	4.60	0.1811	47	80	A1084.6	A1474.6	A7774.6
	4.70	0.1850	47	80	A1084.7	A1474.7	A7774.7
3/16	4.76	0.1874	52	86	A1083/16	A1473/16	A7773/16
	4.80	0.1890	52	86	A1084.8	A1474.8	A7774.8
	4.90	0.1929	52	86	A1084.9	A1474.9	A7774.9
N10	4.92	0.1935	52	86	A108N10		
	5.00	0.1969	52	86	A1085.0	A1475.0	A7775.0
	5.10	0.2008	52	86	A1085.1	A1475.1	A7775.1
13/64	5.16	0.2031	52	86	A10813/64		A77713/64
	5.20	0.2047	52	86	A1085.2	A1475.2	A7775.2
	5.30	0.2087	52	86	A1085.3	A1475.3	A7775.3
	5.40	0.2126	57	93	A1085.4	A1475.4	A7775.4
	5.50	0.2165	57	93	A1085.5	A1475.5	A7775.5
7/32	5.56	0.2189	57	93	A1087/32		A7777/32
	5.60	0.2205	57	93	A1085.6	A1475.6	A7775.6
	5.70	0.2244	57	93	A1085.7	A1475.7	A7775.7
	5.80	0.2283	57	93	A1085.8	A1475.8	A7775.8
	5.90	0.2323	57	93	A1085.9	A1475.9	A7775.9
15/64	5.95	0.2343	57	93	A10815/64		A77715/64
	6.00	0.2362	57	93	A1086.0	A1476.0	A7776.0

d_1 $\varnothing h_8$ Inch	d_1 $\varnothing h_8$ mm	d_1 decimal Inch	l_2 mm	l_1 mm	A108	A147	A777
	6.10	0.2402	63	101	A1086.1	A1476.1	A7776.1
	6.20	0.2441	63	101	A1086.2	A1476.2	A7776.2
	6.30	0.2480	63	101	A1086.3	A1476.3	A7776.3
1/4	6.35	0.2500	63	101	A1081/4	A1471/4	A7771/4
	6.40	0.2520	63	101	A1086.4	A1476.4	A7776.4
	6.50	0.2559	63	101	A1086.5	A1476.5	A7776.5
	6.60	0.2598	63	101	A1086.6	A1476.6	A7776.6
	6.70	0.2638	63	101	A1086.7	A1476.7	A7776.7
17/64	6.75	0.2657	69	109	A10817/64		A77717/64
	6.80	0.2677	69	109	A1086.8	A1476.8	A7776.8
	6.90	0.2717	69	109	A1086.9	A1476.9	A7776.9
	7.00	0.2756	69	109	A1087.0	A1477.0	A7777.0
	7.10	0.2795	69	109	A1087.1	A1477.1	A7777.1
9/32	7.14	0.2811	69	109	A1089/32		A7779/32
	7.20	0.2835	69	109	A1087.2	A1477.2	A7777.2
	7.30	0.2874	69	109	A1087.3	A1477.3	A7777.3
	7.40	0.2913	69	109	A1087.4	A1477.4	A7777.4
	7.50	0.2953	69	109	A1087.5	A1477.5	A7777.5
19/64	7.54	0.2969	75	117	A10819/64		A77719/64
	7.60	0.2992	75	117	A1087.6	A1477.6	A7777.6
	7.70	0.3031	75	117	A1087.7	A1477.7	A7777.7
	7.80	0.3071	75	117	A1087.8	A1477.8	A7777.8
	7.90	0.3110	75	117	A1087.9	A1477.9	A7777.9
5/16	7.94	0.3126	75	117	A1085/16		A7775/16
	8.00	0.3150	75	117	A1088.0	A1478.0	A7778.0
	8.10	0.3189	75	117	A1088.1	A1478.1	A7778.1
	8.20	0.3228	75	117	A1088.2	A1478.2	A7778.2
	8.30	0.3268	75	117	A1088.3	A1478.3	A7778.3
21/64	8.33	0.3280	75	117	A10821/64		A77721/64
	8.40	0.3307	75	117	A1088.4	A1478.4	A7778.4
	8.50	0.3346	75	117	A1088.5	A1478.5	A7778.5
	8.60	0.3386	81	125	A1088.6	A1478.6	A7778.6
	8.70	0.3425	81	125	A1088.7	A1478.7	A7778.7
11/32	8.73	0.3437	81	125	A10811/32		A77711/32
	8.80	0.3465	81	125	A1088.8	A1478.8	A7778.8
	8.90	0.3504	81	125	A1088.9	A1478.9	A7778.9
	9.00	0.3543	81	125	A1089.0	A1479.0	A7779.0
	9.10	0.3583	81	125	A1089.1	A1479.1	A7779.1
23/64	9.13	0.3594	81	125	A10823/64		A77723/64
	9.20	0.3622	81	125	A1089.2	A1479.2	A7779.2
	9.30	0.3661	81	125	A1089.3	A1479.3	A7779.3
	9.40	0.3701	81	125	A1089.4	A1479.4	A7779.4
	9.50	0.3740	81	125	A1089.5	A1479.5	A7779.5
3/8	9.52	0.3748	87	133	A1083/8		A7773/8
	9.60	0.3780	87	133	A1089.6	A1479.6	A7779.6
	9.70	0.3819	87	133	A1089.7	A1479.7	A7779.7
	9.80	0.3858	87	133	A1089.8	A1479.8	A7779.8
	9.90	0.3898	87	133	A1089.9	A1479.9	A7779.9
25/64	9.92	0.3906	87	133	A10825/64		A77725/64
	10.00	0.3937	87	133	A10810.0	A14710.0	A77710.0
	10.10	0.3976	87	133			A77710.1
	10.20	0.4016	87	133	A10810.2	A14710.2	A77710.2
13/32	10.32	0.4063	87	133	A10813/32		A77713/32
	10.50	0.4134	87	133	A10810.5	A14710.5	A77710.5
27/64	10.72	0.4220	94	142	A10827/64		A77727/64
	10.80	0.4252	94	142	A10810.8		A77710.8
	11.00	0.4331	94	142	A10811.0	A14711.0	A77711.0
7/16	11.11	0.4374	94	142	A1087/16		A7777/16
	11.20	0.4409	94	142		A14711.2	A77711.2
	11.50	0.4528	94	142	A10811.5	A14711.5	A77711.5
29/64	11.51	0.4531	94	142	A10829/64		A77729/64
	11.80	0.4646	94	142	A10811.8		A77711.8
15/32	11.91	0.4689	101	151	A10815/32		A77715/32
	12.00	0.4724	101	151	A10812.0	A14712.0	A77712.0
	12.20	0.4803	101	151	A10812.2		A77712.2
31/64	12.30	0.4843	101	151	A10831/64		A77731/64
	12.50	0.4921	101	151	A10812.5	A14712.5	A77712.5
1/2	12.70	0.5000	101	151	A1081/2		A7771/2
	12.80	0.5039	101	151	A10812.8		A77712.8
	12.90	0.5079	101	151	A10812.9		

d_1 $\varnothing h_8$ Inch	d_1 $\varnothing h_8$ mm	d_1 decimal Inch	l_2 mm	l_1 mm	A108	A147	A777
	13.00	0.5118	101	151	A10813.0	A14713.0	A77713.0
	13.50	0.5315	108	160	A10813.5	A14713.5	A77713.5
	14.00	0.5512	108	160	A10814.0	A14714.0	A77714.0
	14.50	0.5709	114	169	A10814.5	A14714.5	A77714.5
	15.00	0.5906	114	169	A10815.0	A14715.0	A77715.0
	15.25	0.6004	120	178	A10815.25		
	15.50	0.6102	120	178	A10815.5		A77715.5
	16.00	0.6299	120	178	A10816.0		A77716.0

A170

- 1/2" vrták, zeslabená stopka paralelní
- Сверло, цилиндрический хвостовик диам. 1/2" (12,7 мм)
- Wiertło 1/2 " z chwytem walcowym
- 1/2" vrták, zoslabená stopka paralelná

A170	•	1.1	1.2	1.3	1.4	1.5	1.6	2.1	2.2	2.3	3.1	3.2	3.3	3.4	4.1	4.2	4.3	5.1	5.2	5.3	6.1	
		6.2	6.3	6.4	7.1	7.2	7.3	7.4	8.1	8.2	8.3	9.1										

A170

HSS

DORMER

4XD

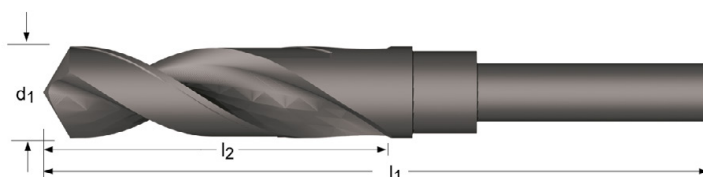

A170



13.00 - 1.1/2

d_1 $\varnothing h_8$ Inch	d_1 $\varnothing h_8$ mm	d_1 decimal Inch	l_2 Inch	l_1 Inch	l_2 mm	l_1 mm	A170
	13.00	0.5118					A17013.0
33/64	13.10	0.5157	3.1/8	6"			A17033/64
17/32	13.49	0.5311	3.1/8	6"			A17017/32
	13.50	0.5315			83	156	A17013.5
35/64	13.89	0.5469	3.1/8	6"			A17035/64
	14.00	0.5512			83	156	A17014.0
9/16	14.29	0.5626	3.1/8	6"			A1709/16
	14.50	0.5709			83	156	A17014.5
37/64	14.68	0.5780	3.1/8	6"			A17037/64
	15.00	0.5906			83	156	A17015.0
19/32	15.08	0.5937	3.1/8	6"			A17019/32
39/64	15.48	0.6094	3.1/8	6"			A17039/64
	15.50	0.6102			83	156	A17015.5
5/8	15.88	0.6252	3.1/8	6"			A1705/8
	16.00	0.6299			84	157	A17016.0
41/64	16.27	0.6406	3.1/8	6"			A17041/64
	16.50	0.6496			84	157	A17016.5
21/32	16.67	0.6563	3.1/8	6"			A17021/32
	17.00	0.6693			84	157	A17017.0
43/64	17.07	0.6720	3.1/8	6"			A17043/64
11/16	17.46	0.6874	3.1/8	6"			A17011/16
	17.50	0.6890			84	157	A17017.5
45/64	17.86	0.7031	3.1/8	6"			A17045/64
	18.00	0.7087			84	157	A17018.0
23/32	18.26	0.7189	3.1/8	6"			A17023/32
	18.50	0.7283			84	157	A17018.5
47/64	18.65	0.7343	3.1/8	6"			A17047/64
	19.00	0.7480			84	157	A17019.0
3/4	19.05	0.7500	3.1/8	6"			A1703/4
49/64	19.45	0.7657	3"	6"			A17049/64
	19.50	0.7677			81	158	A17019.5
25/32	19.84	0.7811	3"	6"			A17025/32
	20.00	0.7874			81	158	A17020.0
51/64	20.24	0.7969	3"	6"			A17051/64
13/16	20.64	0.8126	3"	6"			A17013/16
	21.00	0.8268			82	158	A17021.0
53/64	21.03	0.8280	3"	6"			A17053/64
27/32	21.43	0.8437	3"	6"			A17027/32

d_1 $\varnothing h_8$ Inch	d_1 $\varnothing h_8$ mm	d_1 decimal Inch	l_2 Inch	l_1 Inch	l_2 mm	l_1 mm	A170
55/64	21.83	0.8594	3"	6"			A17055/64
	22.00	0.8661			82	158	A17022.0
7/8	22.22	0.8748	3"	6"			A1707/8
57/64	22.62	0.8906	3"	6"			A17057/64
	23.00	0.9055			82	158	A17023.0
29/32	23.02	0.9063	3"	6"			A17029/32
59/64	23.42	0.9220	3"	6"			A17059/64
15/16	23.81	0.9374	3"	6"			A17015/16
	24.00	0.9449			83	159	A17024.0
61/64	24.21	0.9531	3"	6"			A17061/64
31/32	24.61	0.9689	3"	6"			A17031/32
	25.00	0.9843			83	159	A17025.0
63/64	25.00	0.9843	3"	6"			A17063/64
1"	25.40	1.0000	3"	6"			A1701
1.1/32	26.19	1.0311	3"	6"			A1701.1/32
1.1/16	26.99	1.0626	3"	6"			A1701.1/16
1.7/64	28.18	1.1094	3"	6"			A1701.7/64
1.1/8	28.58	1.1252	3"	6"			A1701.1/8
1.9/64	28.97	1.1406	3"	6"			A1701.9/64
1.5/32	29.37	1.1563	3"	6"			A1701.5/32
1.3/16	30.16	1.1874	3"	6"			A1701.3/16
1.7/32	30.96	1.2189	3"	6"			A1701.7/32
1.1/4	31.75	1.2500	3"	6"			A1701.1/4
1.5/16	33.34	1.3126	3"	6"			A1701.5/16
1.3/8	34.93	1.3752	3"	6"			A1701.3/8
1.7/16	36.51	1.4374	3"	6"			A1701.7/16
1.1/2	38.10	1.5000	3"	6"			A1701.1/2

A160

- Vrták základní délka, naletovaná karbidová špička, 4 fazety
- Универсальное сверло с 4-х гранной заточкой и напайной т/с пластиной
- Wiertło ogólnego stosowania 4 płaszczyznowe ostrze z wlutowaną płytką węglkową
- Vrták základná dĺžka, naletovaná karbidová špička, 4 fazetky

A160	▪	3.1	3.2	3.3	3.4																
	•	1.1	1.2	1.3	1.4	1.5	1.6	2.1	2.2	2.3	4.1	4.2	4.3	5.1	5.2	5.3	6.1	6.2	6.3	6.4	7.1
		7.2	7.3	7.4	8.2	9.1															

A160 **HSS HM** **DIN 338** **4XD** **118°** ST **N**

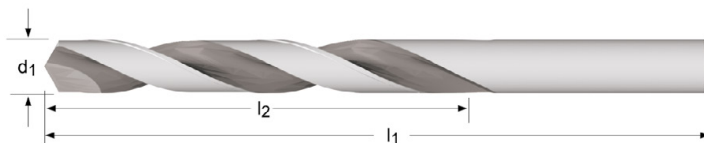

d_1 $\varnothing h_8$ mm	d_1 decimal Inch	l_2 mm	l_1 mm	A160
4.00	0.1575	43	75	A1604.0
4.50	0.1772	47	80	A1604.5
5.00	0.1969	52	86	A1605.0
5.50	0.2165	57	93	A1605.5
6.00	0.2362	57	93	A1606.0
6.50	0.2559	63	101	A1606.5
6.80	0.2677	69	109	A1606.8
7.00	0.2756	69	109	A1607.0
7.50	0.2953	69	109	A1607.5
8.00	0.3150	75	117	A1608.0
8.50	0.3346	75	117	A1608.5
9.00	0.3543	81	125	A1609.0
9.50	0.3740	81	125	A1609.5
10.00	0.3937	87	133	A16010.0
10.20	0.4016	87	133	A16010.2
10.50	0.4134	87	133	A16010.5
11.00	0.4331	94	142	A16011.0
11.50	0.4528	94	142	A16011.5
12.00	0.4724	101	151	A16012.0
13.00	0.5118	101	151	A16013.0
14.00	0.5512	108	160	A16014.0
15.00	0.5906	114	169	A16015.0
16.00	0.6299	120	178	A16016.0

A510

- ADX vrták zákl. délka
- Сверло ADX, короткое исполнение
- Wiertło typu ADX o standardowej długości
- ADX vrták základná dĺžka

A510	▪	1.1	1.2	1.3	1.4	1.5	2.1	2.2	3.1	3.2	3.3	3.4	6.2	6.3	7.2	7.3	7.4	8.1	8.2	8.3
	•	1.6	2.3	4.1	4.2	4.3	5.1	5.2	5.3	6.1	6.4	7.1								

A510

HSS

DIN
338

4XD

130°

TiN



A510



ADX

3.00 - 14.00

d_1 $\varnothing h_8$ Inch	d_1 $\varnothing h_8$ mm	d_1 decimal Inch	l_2 mm	l_1 mm	A510
	3.00	0.1181	33	61	A5103.0
	3.10	0.1220	36	65	A5103.1
1/8	3.18	0.1252	36	65	A5101/8
	3.20	0.1260	36	65	A5103.2
	3.30	0.1299	36	65	A5103.3
	3.40	0.1339	39	70	A5103.4
9/64	3.50	0.1378	39	70	A5103.5
	3.57	0.1406	39	70	A5109/64
	3.60	0.1417	39	70	A5103.6
	3.70	0.1457	39	70	A5103.7
	3.80	0.1496	43	75	A5103.8
5/32	3.90	0.1535	43	75	A5103.9
	3.97	0.1563	43	75	A5105/32
	4.00	0.1575	43	75	A5104.0
	4.10	0.1614	43	75	A5104.1
	4.20	0.1654	43	75	A5104.2
11/64	4.30	0.1693	47	80	A5104.3
	4.37	0.1720	47	80	A51011/64
	4.40	0.1732	47	80	A5104.4
	4.50	0.1772	47	80	A5104.5
	4.60	0.1811	47	80	A5104.6
3/16	4.70	0.1850	47	80	A5104.7
	4.76	0.1874	52	86	A5103/16
	4.80	0.1890	52	86	A5104.8
	4.90	0.1929	52	86	A5104.9
	5.00	0.1969	52	86	A5105.0
13/64	5.10	0.2008	52	86	A5105.1
	5.16	0.2031	52	86	A51013/64
	5.20	0.2047	52	86	A5105.2
	5.30	0.2087	52	86	A5105.3
	5.40	0.2126	57	93	A5105.4
7/32	5.50	0.2165	57	93	A5105.5
	5.56	0.2189	57	93	A5107/32
	5.60	0.2205	57	93	A5105.6
	5.70	0.2244	57	93	A5105.7
	5.80	0.2283	57	93	A5105.8

d ₁ Øh ₈ Inch	d ₁ Øh ₈ mm	d ₁ decimal Inch	l ₂ mm	l ₁ mm	A510
15/64	5.90	0.2323	57	93	A5105.9
	5.95	0.2343	57	93	A51015/64
	6.00	0.2362	57	93	A5106.0
	6.10	0.2402	63	101	A5106.1
1/4	6.20	0.2441	63	101	A5106.2
	6.30	0.2480	63	101	A5106.3
	6.35	0.2500	63	101	A5101/4
	6.40	0.2520	63	101	A5106.4
	6.50	0.2559	63	101	A5106.5
	6.60	0.2598	63	101	A5106.6
	6.70	0.2638	63	101	A5106.7
17/64	6.75	0.2657	69	109	A51017/64
	6.80	0.2677	69	109	A5106.8
	6.90	0.2717	69	109	A5106.9
	7.00	0.2756	69	109	A5107.0
	7.10	0.2795	69	109	A5107.1
9/32	7.14	0.2811	69	109	A5109/32
	7.20	0.2835	69	109	A5107.2
	7.30	0.2874	69	109	A5107.3
	7.40	0.2913	69	109	A5107.4
19/64	7.50	0.2953	69	109	A5107.5
	7.54	0.2969	75	117	A51019/64
	7.60	0.2992	75	117	A5107.6
	7.70	0.3031	75	117	A5107.7
	7.80	0.3071	75	117	A5107.8
5/16	7.90	0.3110	75	117	A5107.9
	7.94	0.3126	75	117	A5105/16
	8.00	0.3150	75	117	A5108.0
	8.10	0.3189	75	117	A5108.1
	8.20	0.3228	75	117	A5108.2
21/64	8.30	0.3268	75	117	A5108.3
	8.33	0.3280	75	117	A51021/64
	8.40	0.3307	75	117	A5108.4
	8.50	0.3346	75	117	A5108.5
	8.60	0.3386	81	125	A5108.6
11/32	8.70	0.3425	81	125	A5108.7
	8.73	0.3437	81	125	A51011/32
	8.80	0.3465	81	125	A5108.8
	8.90	0.3504	81	125	A5108.9
	9.00	0.3543	81	125	A5109.0
23/64	9.10	0.3583	81	125	A5109.1
	9.13	0.3594	81	125	A51023/64
	9.20	0.3622	81	125	A5109.2
	9.30	0.3661	81	125	A5109.3
	9.40	0.3701	81	125	A5109.4
3/8	9.50	0.3740	81	125	A5109.5
	9.52	0.3748	87	133	A5103/8
	9.60	0.3780	87	133	A5109.6
	9.70	0.3819	87	133	A5109.7
	9.80	0.3858	87	133	A5109.8
25/64	9.90	0.3898	87	133	A5109.9
	9.92	0.3906	87	133	A51025/64
	10.00	0.3937	87	133	A51010.0
	10.10	0.3976	87	133	A51010.1
	10.20	0.4016	87	133	A51010.2
13/32	10.30	0.4055	87	133	A51010.3
	10.32	0.4063	87	133	A51013/32
	10.40	0.4094	87	133	A51010.4
	10.50	0.4134	87	133	A51010.5
	10.60	0.4173	87	133	A51010.6
27/64	10.70	0.4213	94	142	A51010.7
	10.72	0.4220	94	142	A51027/64
	10.80	0.4252	94	142	A51010.8
	10.90	0.4291	94	142	A51010.9
	11.00	0.4331	94	142	A51011.0
7/16	11.10	0.4370	94	142	A51011.1
	11.11	0.4374	94	142	A5107/16
	11.20	0.4409	94	142	A51011.2
	11.30	0.4449	94	142	A51011.3
	11.40	0.4488	94	142	A51011.4

d_1 $\varnothing h_8$ Inch	d_1 $\varnothing h_8$ mm	d_1 decimal Inch	l_2 mm	l_1 mm	A510
29/64	11.50	0.4528	94	142	A51011.5
	11.51	0.4531	94	142	A51029/64
	11.60	0.4567	94	142	A51011.6
	11.70	0.4606	94	142	A51011.7
	11.80	0.4646	94	142	A51011.8
15/32	11.90	0.4685	101	151	A51011.9
	11.91	0.4689	101	151	A51015/32
	12.00	0.4724	101	151	A51012.0
	12.10	0.4764	101	151	A51012.1
	12.20	0.4803	101	151	A51012.2
31/64	12.30	0.4843	101	151	A51012.3
	12.30	0.4843	101	151	A51031/64
	12.40	0.4882	101	151	A51012.4
	12.50	0.4921	101	151	A51012.5
	12.60	0.4961	101	151	A51012.6
1/2	12.70	0.5000	101	151	A51012.7
	12.70	0.5000	101	151	A5101/2
	12.80	0.5039	101	151	A51012.8
	12.90	0.5079	101	151	A51012.9
	13.00	0.5118	101	151	A51013.0
	14.00	0.5512	108	160	A51014.0

- A553**
- ADX vrták - vnitřní chlazení
 - Сверло ADX с подводом СОЖ
 - Wiertło typu ADX z chłodzeniem wew.
 - ADX vrták - vnútorné chladienie

A553	▪	1.1	1.2	1.3	1.4	1.5	1.6	2.1	2.2	3.1	3.2	3.3	3.4	4.1	6.2	6.3	7.2	7.3	7.4	8.1
	•	2.3	4.2	4.3	5.1	5.2	5.3	6.1	6.4	7.1										

A553 HSS-E



5XD

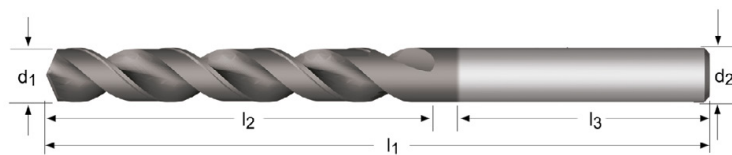

A553



ADX

5.00 - 20.00

d_1 \varnothing_{h_8} mm	d_1 decimal Inch	l_2 mm	l_1 mm	l_3 mm	d_2 \varnothing_{h_6} mm	A553
5.00	0.1969	36	79	36	6	A5535.0
5.20	0.2047	38	79	36	6	A5535.2
5.50	0.2165	40	79	36	6	A5535.5
6.00	0.2362	43	79	36	6	A5536.0
6.30	0.2480	46	87	36	8	A5536.3
6.50	0.2559	47	87	36	8	A5536.5
6.80	0.2677	48	87	36	8	A5536.8
6.90	0.2717	48	87	36	8	A5536.9
7.00	0.2756	48	87	36	8	A5537.0
7.40	0.2913	54	94	36	8	A5537.4
7.50	0.2953	54	94	36	8	A5537.5
8.00	0.3150	58	94	36	8	A5538.0
8.50	0.3346	75	130	40	10	A5538.5
8.70	0.3425	75	130	40	10	A5538.7
9.00	0.3543	75	130	40	10	A5539.0
9.50	0.3740	75	130	40	10	A5539.5
10.00	0.3937	75	130	40	10	A55310.0
10.20	0.4016	87	150	45	12	A55310.2
10.30	0.4055	87	150	45	12	A55310.3
10.50	0.4134	87	150	45	12	A55310.5
11.00	0.4331	94	150	45	12	A55311.0
11.30	0.4449	94	150	45	12	A55311.3
11.50	0.4528	94	150	45	12	A55311.5
12.00	0.4724	94	150	45	12	A55312.0
12.50	0.4921	101	160	45	14	A55312.5
13.00	0.5118	101	160	45	14	A55313.0
13.50	0.5315	101	160	45	14	A55313.5
14.00	0.5512	101	160	45	14	A55314.0
14.25	0.5610	108	170	48	16	A55314.25
14.50	0.5709	108	170	48	16	A55314.5
15.00	0.5906	108	170	48	16	A55315.0
15.25	0.6004	108	170	48	16	A55315.25
15.50	0.6102	108	170	48	16	A55315.5
16.00	0.6299	108	170	48	16	A55316.0
16.50	0.6496	125	190	48	18	A55316.5
17.00	0.6693	125	190	48	18	A55317.0

d₁ Øh₈ mm	d₁ decimal Inch	l₂ mm	l₁ mm	l₃ mm	d₂ Øh₆ mm	A553
17.50	0.6890	130	190	48	18	A55317.5
17.75	0.6988	130	190	48	18	A55317.75
18.00	0.7087	130	190	48	18	A55318.0
19.00	0.7480	135	200	50	20	A55319.0
19.25	0.7579	140	200	50	20	A55319.25
20.00	0.7874	140	200	50	20	A55320.0

- A900**
- PFX vrták základní délka
 - Спиральное сверло PFX, короткое исполнение
- A901**
- Wiertło typu PFX
 - PFX vrták základná dĺžka

A900	▪	1.1	1.2	1.3	1.4	1.5	1.6	2.1	2.2	2.3	4.1	4.2	4.3	5.1	5.2	5.3	7.2
	•	3.1	3.2	3.3	3.4	6.1	6.2	6.3	6.4	7.1	7.3	7.4	8.1	8.2			
A901	▪	1.1	1.2	1.3	1.4	1.5	1.6	2.1	2.2	2.3	3.1	3.2	3.3	3.4	7.4		
	•	4.1	4.2	4.3	5.1	5.2	5.3	6.3	6.4								

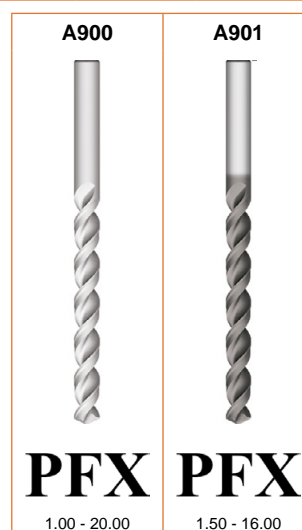
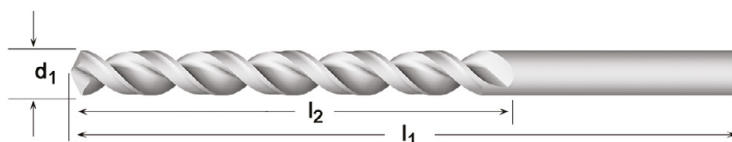
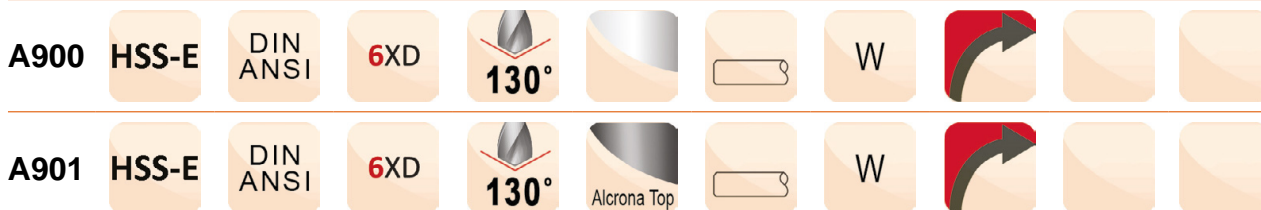

d_1 $\varnothing h_8$ Inch	d_1 $\varnothing h_8$ mm	d_1 decimal Inch	l_2 mm	l_1 mm	A900	A901
	1.00	0.0394	12	34	A9001.0	
	1.10	0.0433	14	36	A9001.1	
3/64	1.19	0.0469	19	44	A9003/64	
	1.20	0.0472	16	38	A9001.2	
	1.25	0.0492	16	36	A9001.25	
	1.30	0.0512	16	38	A9001.3	
	1.40	0.0551	18	40	A9001.4	
	1.50	0.0591	18	40	A9001.5	A9011.5
	1.55	0.0610	20	43	A9001.55	A9011.55
1/16	1.59	0.0626	22	48	A9001/16	A9011/16
	1.60	0.0630	20	43	A9001.6	A9011.6
	1.70	0.0669	20	43	A9001.7	
	1.75	0.0689	22	46	A9001.75	A9011.75
	1.80	0.0709	22	46	A9001.8	A9011.8
	1.90	0.0748	22	46	A9001.9	A9011.9
5/64	1.98	0.0780	25	51	A9005/64	A9015/64
	2.00	0.0787	24	49	A9002.0	A9012.0
	2.10	0.0827	24	49	A9002.1	A9012.1
	2.15	0.0846	27	53	A9002.15	A9012.15
	2.20	0.0866	27	53	A9002.2	
	2.30	0.0906	27	53	A9002.3	
3/32	2.38	0.0937	32	57	A9003/32	A9013/32
	2.40	0.0945	30	57	A9002.4	A9012.4
	2.50	0.0984	30	57	A9002.5	A9012.5
	2.60	0.1024	30	57	A9002.6	A9012.6
	2.70	0.1063	33	61	A9002.7	A9012.7
7/64	2.78	0.1094	38	67	A9007/64	A9017/64
	2.80	0.1102	33	61	A9002.8	

d_1 $\varnothing h_8$ Inch	d_1 $\varnothing h_8$ mm	d_1 decimal Inch	l_2 mm	l_1 mm	A900	A901
	2.90	0.1142	33	61	A9002.9	A9012.9
	3.00	0.1181	33	61	A9003.0	A9013.0
	3.10	0.1220	36	65	A9003.1	A9013.1
1/8	3.18	0.1252	41	70	A9001/8	A9011/8
	3.20	0.1260	36	65	A9003.2	A9013.2
	3.30	0.1299	36	65	A9003.3	A9013.3
	3.40	0.1339	39	70	A9003.4	A9013.4
	3.50	0.1378	39	70	A9003.5	A9013.5
9/64	3.57	0.1406	44	73	A9009/64	A9019/64
	3.60	0.1417	39	70	A9003.6	A9013.6
	3.70	0.1457	39	70	A9003.7	A9013.7
	3.80	0.1496	43	75	A9003.8	A9013.8
	3.90	0.1535	43	75	A9003.9	A9013.9
5/32	3.97	0.1563	51	79	A9005/32	A9015/32
	4.00	0.1575	43	75	A9004.0	A9014.0
	4.10	0.1614	43	75	A9004.1	A9014.1
	4.20	0.1654	43	75	A9004.2	A9014.2
	4.30	0.1693	47	80	A9004.3	A9014.3
11/64	4.37	0.1720	54	83	A90011/64	A90111/64
	4.40	0.1732	47	80	A9004.4	A9014.4
	4.50	0.1772	47	80	A9004.5	A9014.5
	4.60	0.1811	47	80	A9004.6	A9014.6
	4.70	0.1850	47	80	A9004.7	A9014.7
3/16	4.76	0.1874	59	89	A9003/16	A9013/16
	4.80	0.1890	52	86	A9004.8	A9014.8
	4.90	0.1929	52	86	A9004.9	A9014.9
	5.00	0.1969	52	86	A9005.0	A9015.0
	5.10	0.2008	52	86	A9005.1	A9015.1
13/64	5.16	0.2031	62	92	A90013/64	A90113/64
	5.20	0.2047	52	86	A9005.2	A9015.2
	5.30	0.2087	52	86	A9005.3	A9015.3
	5.40	0.2126	57	93	A9005.4	A9015.4
	5.50	0.2165	57	93	A9005.5	A9015.5
7/32	5.56	0.2189	64	95	A9007/32	A9017/32
	5.60	0.2205	57	93	A9005.6	A9015.6
	5.70	0.2244	57	93	A9005.7	A9015.7
	5.80	0.2283	57	93	A9005.8	A9015.8
	5.90	0.2323	57	93	A9005.9	A9015.9
15/64	5.95	0.2343	67	98	A90015/64	A90115/64
	6.00	0.2362	57	93	A9006.0	A9016.0
	6.10	0.2402	63	101	A9006.1	A9016.1
	6.20	0.2441	63	101	A9006.2	A9016.2
	6.30	0.2480	63	101	A9006.3	A9016.3
1/4	6.35	0.2500	70	102	A9001/4	A9011/4
	6.40	0.2520	63	101	A9006.4	A9016.4
	6.50	0.2559	63	101	A9006.5	A9016.5
	6.60	0.2598	63	101	A9006.6	A9016.6
	6.70	0.2638	63	101	A9006.7	A9016.7
17/64	6.75	0.2657	73	105	A90017/64	A90117/64
	6.80	0.2677	69	109	A9006.8	A9016.8
	6.90	0.2717	69	109	A9006.9	A9016.9
	7.00	0.2756	69	109	A9007.0	A9017.0
	7.10	0.2795	69	109	A9007.1	A9017.1
9/32	7.14	0.2811	75	108	A9009/32	A9019/32
	7.20	0.2835	69	109	A9007.2	A9017.2
	7.30	0.2874	69	109	A9007.3	A9017.3
	7.40	0.2913	69	109	A9007.4	A9017.4
	7.50	0.2953	69	109	A9007.5	A9017.5
19/64	7.54	0.2969	78	111	A90019/64	A90119/64
	7.60	0.2992	75	117	A9007.6	A9017.6
	7.70	0.3031	75	117	A9007.7	A9017.7
	7.80	0.3071	75	117	A9007.8	A9017.8
	7.90	0.3110	75	117	A9007.9	A9017.9
5/16	7.94	0.3126	81	114	A9005/16	A9015/16
	8.00	0.3150	75	117	A9008.0	A9018.0
	8.10	0.3189	75	117	A9008.1	A9018.1
	8.20	0.3228	75	117	A9008.2	A9018.2
	8.30	0.3268	75	117	A9008.3	A9018.3
21/64	8.33	0.3280	84	117	A90021/64	A90121/64
	8.40	0.3307	75	117	A9008.4	A9018.4

d_1 \varnothing_{h_8} Inch	d_1 \varnothing_{h_8} mm	d_1 decimal Inch	l_2 mm	l_1 mm	A900	A901
	8.50	0.3346	75	117	A9008.5	A9018.5
	8.60	0.3386	81	125	A9008.6	A9018.6
	8.70	0.3425	81	125	A9008.7	A9018.7
11/32	8.73	0.3437	87	121	A90011/32	A90111/32
	8.80	0.3465	81	125	A9008.8	A9018.8
	8.90	0.3504	81	125	A9008.9	A9018.9
	9.00	0.3543	81	125	A9009.0	A9019.0
	9.10	0.3583	81	125	A9009.1	A9019.1
23/64	9.13	0.3594	89	124	A90023/64	A90123/64
	9.20	0.3622	81	125	A9009.2	A9019.2
	9.30	0.3661	81	125	A9009.3	A9019.3
	9.40	0.3701	81	125	A9009.4	A9019.4
	9.50	0.3740	81	125	A9009.5	A9019.5
3/8	9.52	0.3748	92	127	A9003/8	A9013/8
	9.60	0.3780	87	133	A9009.6	A9019.6
	9.70	0.3819	87	133	A9009.7	A9019.7
	9.80	0.3858	87	133	A9009.8	A9019.8
	9.90	0.3898	87	133	A9009.9	A9019.9
25/64	9.92	0.3906	95	130	A90025/64	A90125/64
	10.00	0.3937	87	133	A90010.0	A90110.0
	10.20	0.4016	87	133	A90010.2	A90110.2
	10.30	0.4055	87	133	A90010.3	A90110.3
13/32	10.32	0.4063	98	133	A90013/32	A90113/32
	10.40	0.4094	87	133	A90010.4	A90110.4
	10.50	0.4134	87	133	A90010.5	A90110.5
27/64	10.72	0.4220	100	137	A90027/64	A90127/64
	10.80	0.4252	94	142	A90010.8	A90110.8
	11.00	0.4331	94	142	A90011.0	A90111.0
7/16	11.11	0.4374	103	140	A9007/16	A9017/16
	11.50	0.4528	94	142	A90011.5	A90111.5
29/64	11.51	0.4531	106	143	A90029/64	A90129/64
	11.80	0.4646	94	142	A90011.8	A90111.8
15/32	11.91	0.4689	110	146	A90015/32	A90115/32
	12.00	0.4724	101	151	A90012.0	A90112.0
31/64	12.30	0.4843	111	149	A90031/64	A90131/64
	12.50	0.4921	101	151	A90012.5	A90112.5
1/2	12.70	0.5000	101	151	A9001/2	A9011/2
	13.00	0.5118	101	151	A90013.0	A90113.0
33/64	13.10	0.5157	122	168	A90033/64	A90133/64
	13.50	0.5315	108	160	A90013.5	A90113.5
35/64	13.89	0.5469	122	168	A90035/64	A90135/64
	14.00	0.5512	108	160	A90014.0	A90114.0
9/16	14.29	0.5626	122	168	A9009/16	A9019/16
	14.50	0.5709	114	169	A90014.5	A90114.5
37/64	14.68	0.5780	122	168	A90037/64	A90137/64
	15.00	0.5906	114	169	A90015.0	A90115.0
19/32	15.08	0.5937	132	181	A90019/32	A90119/32
39/64	15.48	0.6094	132	181	A90039/64	A90139/64
	15.50	0.6102	120	178	A90015.5	A90115.5
5/8	15.88	0.6252	132	181	A9005/8	A9015/8
	16.00	0.6299	120	178	A90016.0	A90116.0
41/64	16.27	0.6406	132	181	A90041/64	
	16.50	0.6496	125	184	A90016.5	
21/32	16.67	0.6563	132	181	A90021/32	
	17.00	0.6693	125	184	A90017.0	
43/64	17.07	0.6720	143	194	A90043/64	
11/16	17.46	0.6874	143	194	A90011/16	
	17.50	0.6890	130	191	A90017.5	
45/64	17.86	0.7031	130	191	A90045/64	
	18.00	0.7087	130	191	A90018.0	
23/32	18.26	0.7189	130	191	A90023/32	
	18.50	0.7283	135	198	A90018.5	
47/64	18.65	0.7343	135	198	A90047/64	
	19.00	0.7480	135	198	A90019.0	
3/4	19.05	0.7500	135	198	A9003/4	
49/64	19.45	0.7657	135	198	A90049/64	
	19.50	0.7677	140	205	A90019.5	
25/32	19.84	0.7811	140	205	A90025/32	
	20.00	0.7874	140	205	A90020.0	

- A243** • Vrták prodloužený, letecký průmysl 150 mm celková délka
 • Сверло для аэрокосмической промышленности Общая длина 150 мм
- A244** • Wiertło przedłużane dla przemysłu lotniczego Długość całkowita 150 mm
 • Vrták predĺžený, letecký priemysel 150 mm celková dĺžka

A243; A244	▪	1.5	1.6	2.2	2.3	3.4	4.1	4.2	4.3	5.1	6.4	7.4
	•	1.3	1.4	2.1	3.1	3.2	3.3	5.2	5.3	6.3	9.1	

A243	HSS	NAS 907	4XD	135°			N			
A244	HSS	NAS 907	4XD	118°			N			



d_1 \varnothing_{h_8} Inch	d_1 decimal Inch	l_2 Inch	l_1 Inch	A243	A244
3/32	0.0938	1.1/4	6"	A2433/32X6	
40	0.0980	1.3/8	6"	A243N40X6	
1/8	0.1250	1.5/8	6"	A2431/8X6	A2441/8X6
30	0.1285	1.5/8	6"	A243N30X6	
5/32	0.1563	2"	6"	A2435/32X6	A2445/32X6
21	0.1590	2.1/8	6"	A243N21X6	
20	0.1610	2.1/8	6"	A243N20X6	
3/16	0.1875	2.5/16	6"	A2433/16X6	A2443/16X6
11	0.1910	2.5/16	6"	A243N11X6	
10	0.1935	2.7/16	6"	A243N10X6	
1/4	0.2500	2.3/4	6"	A2431/4X6	A2441/4X6

- A110**
- Vrtáky dlouhé
 - Спиральное сверло, длинное исполнение
 - Wiertło długie
 - Vrták dlhý
- Broušený povrch pod 1,0 mm, 1/16"
 Полированные менее 1,0 мм и 1/16"
 Niepokrywane poniżej 1,0 mm, 1/16"
 Brúsený povrch pod 1,0 mm, 1/16"

A110	•	1.1	1.2	1.3	1.4	1.5	1.6	2.1	2.2	2.3	3.1	3.2	3.3	3.4	4.1	4.2	4.3	5.1	5.2	5.3	6.1	
		6.2	6.3	6.4	7.1	7.2	7.3	7.4	8.1	8.2	8.3	9.1										

A110 HSS DIN 340 6XD 118° ST N

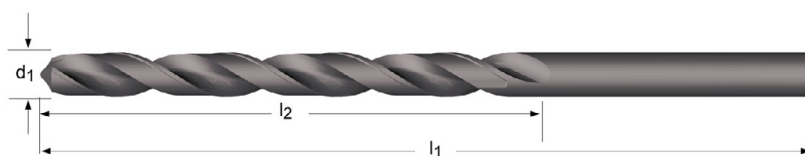

d_1 $\varnothing h_8$ Inch	d_1 $\varnothing h_8$ mm	d_1 decimal Inch	l_2 mm	l_1 mm	A110
	0.50	0.0197	12	32	A110.5
	0.60	0.0236	15	35	A110.6
	0.70	0.0276	21	42	A110.7
1/32	0.79	0.0311	25	46	A1101/32
	0.80	0.0315	25	46	A110.8
	0.90	0.0354	29	51	A110.9
	1.00	0.0394	33	56	A1101.0
	1.10	0.0433	37	60	A1101.1
	1.20	0.0472	41	65	A1101.2
	1.30	0.0512	41	65	A1101.3
	1.40	0.0551	45	70	A1101.4
1/16	1.50	0.0591	45	70	A1101.5
	1.59	0.0626	50	76	A1101/16
	1.60	0.0630	50	76	A1101.6
	1.70	0.0669	50	76	A1101.7
	1.75	0.0689	53	80	A1101.75
	1.80	0.0709	53	80	A1101.8
	1.90	0.0748	53	80	A1101.9
5/64	1.98	0.0780	56	85	A1105/64
	2.00	0.0787	56	85	A1102.0
	2.05	0.0807	56	85	A1102.05
	2.10	0.0827	56	85	A1102.1
	2.20	0.0866	59	90	A1102.2
	2.25	0.0886	59	90	A1102.25
	2.30	0.0906	59	90	A1102.3
3/32	2.38	0.0937	62	95	A1103/32
	2.40	0.0945	62	95	A1102.4
	2.50	0.0984	62	95	A1102.5
	2.60	0.1024	62	95	A1102.6
7/64	2.70	0.1063	66	100	A1102.7
	2.78	0.1094	66	100	A1107/64
	2.80	0.1102	66	100	A1102.8
	2.90	0.1142	66	100	A1102.9
	3.00	0.1181	66	100	A1103.0
1/8	3.10	0.1220	69	106	A1103.1
	3.18	0.1252	69	106	A1101/8
	3.20	0.1260	69	106	A1103.2
	3.25	0.1280	69	106	A1103.25

d₁ Øh₈ Inch	d₁ Øh₈ mm	d₁ decimal Inch	l₂ mm	l₁ mm	A110
9/64	3.30	0.1299	69	106	A1103.3
	3.40	0.1339	73	112	A1103.4
	3.50	0.1378	73	112	A1103.5
	3.57	0.1406	73	112	A1109/64
	3.60	0.1417	73	112	A1103.6
	3.70	0.1457	73	112	A1103.7
	3.75	0.1476	73	112	A1103.75
	3.80	0.1496	78	119	A1103.8
5/32	3.90	0.1535	78	119	A1103.9
	3.97	0.1563	78	119	A1105/32
	4.00	0.1575	78	119	A1104.0
	4.10	0.1614	78	119	A1104.1
	4.20	0.1654	78	119	A1104.2
	4.25	0.1673	78	119	A1104.25
	4.30	0.1693	82	126	A1104.3
	4.37	0.1720	82	126	A11011/64
11/64	4.40	0.1732	82	126	A1104.4
	4.50	0.1772	82	126	A1104.5
	4.60	0.1811	82	126	A1104.6
	4.70	0.1850	82	126	A1104.7
	4.75	0.1870	82	126	A1104.75
	4.76	0.1874	87	132	A1103/16
	4.80	0.1890	87	132	A1104.8
	4.90	0.1929	87	132	A1104.9
3/16	5.00	0.1969	87	132	A1105.0
	5.10	0.2008	87	132	A1105.1
	5.16	0.2031	87	132	A11013/64
	5.20	0.2047	87	132	A1105.2
	5.25	0.2067	87	132	A1105.25
	5.30	0.2087	87	132	A1105.3
	5.40	0.2126	91	139	A1105.4
	5.50	0.2165	91	139	A1105.5
7/32	5.56	0.2189	91	139	A1107/32
	5.60	0.2205	91	139	A1105.6
	5.70	0.2244	91	139	A1105.7
	5.75	0.2264	91	139	A1105.75
	5.80	0.2283	91	139	A1105.8
	5.90	0.2323	91	139	A1105.9
	5.95	0.2343	91	139	A11015/64
	6.00	0.2362	91	139	A1106.0
15/64	6.10	0.2402	97	148	A1106.1
	6.20	0.2441	97	148	A1106.2
	6.25	0.2461	97	148	A1106.25
	6.30	0.2480	97	148	A1106.3
	6.35	0.2500	97	148	A1101/4
	6.40	0.2520	97	148	A1106.4
	6.50	0.2559	97	148	A1106.5
	6.60	0.2598	97	148	A1106.6
17/64	6.70	0.2638	97	148	A1106.7
	6.75	0.2657	102	156	A11017/64
	6.75	0.2657	102	156	A1106.75
	6.80	0.2677	102	156	A1106.8
	6.90	0.2717	102	156	A1106.9
	7.00	0.2756	102	156	A1107.0
	7.10	0.2795	102	156	A1107.1
	9/32	7.14	0.2811	102	156
7.20		0.2835	102	156	A1107.2
7.25		0.2854	102	156	A1107.25
7.30		0.2874	102	156	A1107.3
7.40		0.2913	102	156	A1107.4
7.50		0.2953	102	156	A1107.5
7.60		0.2992	109	165	A1107.6
7.70		0.3031	109	165	A1107.7
5/16	7.75	0.3051	109	165	A1107.75
	7.80	0.3071	109	165	A1107.8
	7.90	0.3110	109	165	A1107.9
	7.94	0.3126	109	165	A1105/16
	8.00	0.3150	109	165	A1108.0
	8.10	0.3189	109	165	A1108.1
	8.20	0.3228	109	165	A1108.2

d_1 $\varnothing h_8$ Inch	d_1 $\varnothing h_8$ mm	d_1 decimal Inch	l_2 mm	l_1 mm	A110
	8.25	0.3248	109	165	A1108.25
	8.30	0.3268	109	165	A1108.3
	8.40	0.3307	109	165	A1108.4
	8.50	0.3346	109	165	A1108.5
	8.60	0.3386	115	175	A1108.6
	8.70	0.3425	115	175	A1108.7
11/32	8.73	0.3437	115	175	A11011/32
	8.75	0.3445	115	175	A1108.75
	8.80	0.3465	115	175	A1108.8
	8.90	0.3504	115	175	A1108.9
	9.00	0.3543	115	175	A1109.0
	9.10	0.3583	115	175	A1109.1
	9.20	0.3622	115	175	A1109.2
	9.25	0.3642	115	175	A1109.25
	9.30	0.3661	115	175	A1109.3
	9.40	0.3701	115	175	A1109.4
	9.50	0.3740	115	175	A1109.5
3/8	9.52	0.3748	121	184	A1103/8
	9.60	0.3780	121	184	A1109.6
	9.70	0.3819	121	184	A1109.7
	9.75	0.3839	121	184	A1109.75
	9.80	0.3858	121	184	A1109.8
	9.90	0.3898	121	184	A1109.9
	10.00	0.3937	121	184	A11010.0
	10.10	0.3976	121	184	A11010.1
	10.20	0.4016	121	184	A11010.2
	10.25	0.4035	121	184	A11010.25
	10.30	0.4055	121	184	A11010.3
13/32	10.32	0.4063	121	184	A11013/32
	10.50	0.4134	121	184	A11010.5
	10.75	0.4232	128	195	A11010.75
	10.80	0.4252	128	195	A11010.8
	11.00	0.4331	128	195	A11011.0
7/16	11.11	0.4374	128	195	A1107/16
	11.25	0.4429	128	195	A11011.25
	11.40	0.4488	128	195	A11011.4
	11.50	0.4528	128	195	A11011.5
	11.75	0.4626	128	195	A11011.75
	12.00	0.4724	134	205	A11012.0
	12.10	0.4764	134	205	A11012.1
	12.25	0.4823	134	205	A11012.25
	12.50	0.4921	134	205	A11012.5
1/2	12.70	0.5000	134	205	A1101/2
	13.00	0.5118	134	205	A11013.0
17/32	13.49	0.5311	140	214	A11017/32
	13.50	0.5315	140	214	A11013.5
	14.00	0.5512	140	214	A11014.0
9/16	14.29	0.5626	144	220	A1109/16
	14.50	0.5709	144	220	A11014.5
	15.00	0.5906	144	220	A11015.0
	15.50	0.6102	149	227	A11015.5
5/8	15.88	0.6252	149	227	A1105/8
	16.00	0.6299	149	227	A11016.0
	16.50	0.6496	154	235	A11016.5
	17.00	0.6693	154	235	A11017.0
11/16	17.46	0.6874	158	241	A11011/16
	17.50	0.6890	158	241	A11017.5
	18.00	0.7087	158	241	A11018.0
	18.50	0.7283	162	247	A11018.5
	19.00	0.7480	162	247	A11019.0
3/4	19.05	0.7500	166	254	A1103/4
	19.50	0.7677	166	254	A11019.5
	20.00	0.7874	166	254	A11020.0
	21.00	0.8268	171	261	A11021.0
	22.00	0.8661	176	268	A11022.0
7/8	22.22	0.8748	176	268	A1107/8
15/16	23.81	0.9374	185	282	A11015/16
1"	25.40	1.0000	190	290	A1101

- A940** • PFX vrták dlouhý
• Спиральное сверло PFX, длинное исполнение
- A941** • Wiertło typu PFX, długie
• PFX vrták dlhý

A940	▪	1.1	1.2	1.3	1.4	1.5	1.6	2.1	2.2	2.3	4.1	4.2	4.3	7.2	
	•	3.2	3.3	3.4	6.1	6.2	6.3	6.4	7.1	7.3	7.4	8.1	8.2		
A941	▪	1.1	1.2	1.3	1.4	1.5	1.6	2.1	2.2	2.3	3.1	3.2	3.3	3.4	7.4
	•	4.1	4.2	4.3	6.3	6.4									

A940	HSS-E	DIN ANSI	10XD	130°			W			
A941	HSS-E	DIN ANSI	10XD	130°	Alcrona Top		W			

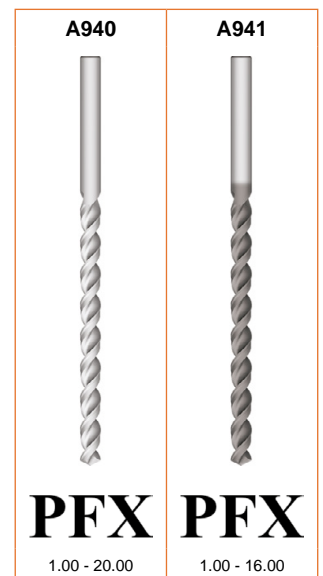
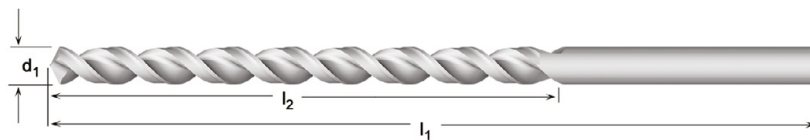

d_1 \varnothing_{h_8} Inch	d_1 \varnothing_{h_8} mm	d_1 decimal Inch	l_2 mm	l_1 mm	A940	A941
	1.00	0.0394	33	56	A9401.0	A9411.0
	1.10	0.0433	37	60	A9401.1	
3/64	1.19	0.0469	29	57	A9403/64	A9413/64
	1.20	0.0472	41	65	A9401.2	
	1.30	0.0512	41	65	A9401.3	
	1.40	0.0551	45	70	A9401.4	
	1.50	0.0591	45	70	A9401.5	A9411.5
1/16	1.59	0.0626	44	76	A9401/16	A9411/16
	1.60	0.0630	50	76	A9401.6	
	1.70	0.0669	50	76	A9401.7	
	1.80	0.0709	53	80	A9401.8	
	1.90	0.0748	53	80	A9401.9	
5/64	1.98	0.0780	51	95	A9405/64	A9415/64
	2.00	0.0787	56	85	A9402.0	A9412.0
	2.10	0.0827	56	85	A9402.1	
	2.20	0.0866	59	90	A9402.2	
	2.30	0.0906	59	90	A9402.3	
3/32	2.38	0.0937	57	108	A9403/32	A9413/32
	2.40	0.0945	62	95	A9402.4	
	2.50	0.0984	62	95	A9402.5	A9412.5
	2.60	0.1024	62	95	A9402.6	
	2.70	0.1063	66	100	A9402.7	
7/64	2.78	0.1094	64	117	A9407/64	A9417/64
	2.80	0.1102	66	100	A9402.8	
	2.90	0.1142	66	100	A9402.9	
	3.00	0.1181	66	100	A9403.0	A9413.0

d_1 $\varnothing h_8$ Inch	d_1 $\varnothing h_8$ mm	d_1 decimal Inch	l_2 mm	l_1 mm	A940	A941
1/8	3.10	0.1220	69	106	A9403.1	A9413.1
	3.18	0.1252	70	130	A9401/8	A9411/8
	3.20	0.1260	69	106	A9403.2	A9413.2
	3.30	0.1299	69	106	A9403.3	A9413.3
	3.40	0.1339	73	112	A9403.4	A9413.4
9/64	3.50	0.1378	73	112	A9403.5	A9413.5
	3.57	0.1406	76	137	A9409/64	A9419/64
	3.60	0.1417	73	112	A9403.6	A9413.6
	3.70	0.1457	73	112	A9403.7	A9413.7
	3.80	0.1496	78	119	A9403.8	A9413.8
5/32	3.90	0.1535	78	119	A9403.9	A9413.9
	3.97	0.1563	76	137	A9405/32	A9415/32
	4.00	0.1575	78	119	A9404.0	A9414.0
	4.10	0.1614	78	119	A9404.1	A9414.1
	4.20	0.1654	78	119	A9404.2	A9414.2
11/64	4.30	0.1693	82	126	A9404.3	A9414.3
	4.37	0.1720	86	146	A94011/64	A94111/64
	4.40	0.1732	82	126	A9404.4	A9414.4
	4.50	0.1772	82	126	A9404.5	A9414.5
	4.60	0.1811	82	126	A9404.6	A9414.6
3/16	4.70	0.1850	82	126	A9404.7	A9414.7
	4.76	0.1874	86	146	A9403/16	A9413/16
	4.80	0.1890	87	132	A9404.8	A9414.8
	4.90	0.1929	87	132	A9404.9	A9414.9
	5.00	0.1969	87	132	A9405.0	A9415.0
13/64	5.10	0.2008	87	132	A9405.1	A9415.1
	5.16	0.2031	92	152	A94013/64	A94113/64
	5.20	0.2047	87	132	A9405.2	A9415.2
	5.30	0.2087	87	132	A9405.3	A9415.3
	5.40	0.2126	91	139	A9405.4	A9415.4
7/32	5.50	0.2165	91	139	A9405.5	A9415.5
	5.56	0.2189	92	152	A9407/32	A9417/32
	5.60	0.2205	91	139	A9405.6	A9415.6
	5.70	0.2244	91	139	A9405.7	A9415.7
	5.80	0.2283	91	139	A9405.8	A9415.8
15/64	5.90	0.2323	91	139	A9405.9	A9415.9
	5.95	0.2343	95	156	A94015/64	A94115/64
	6.00	0.2362	91	139	A9406.0	A9416.0
	6.10	0.2402	97	148	A9406.1	A9416.1
	6.20	0.2441	97	148	A9406.2	A9416.2
1/4	6.30	0.2480	97	148	A9406.3	A9416.3
	6.35	0.2500	95	156	A9401/4	A9411/4
	6.40	0.2520	97	148	A9406.4	A9416.4
	6.50	0.2559	97	148	A9406.5	A9416.5
	6.60	0.2598	97	148	A9406.6	A9416.6
17/64	6.70	0.2638	97	148	A9406.7	A9416.7
	6.75	0.2657	98	159	A94017/64	A94117/64
	6.80	0.2677	102	156	A9406.8	A9416.8
	6.90	0.2717	102	156	A9406.9	A9416.9
	7.00	0.2756	102	156	A9407.0	A9417.0
9/32	7.10	0.2795	102	156	A9407.1	A9417.1
	7.14	0.2811	98	159	A9409/32	A9419/32
	7.20	0.2835	102	156	A9407.2	A9417.2
	7.30	0.2874	102	156	A9407.3	A9417.3
	7.40	0.2913	102	156	A9407.4	A9417.4
19/64	7.50	0.2953	102	156	A9407.5	A9417.5
	7.54	0.2969	102	162	A94019/64	A94119/64
	7.60	0.2992	109	165	A9407.6	A9417.6
	7.70	0.3031	109	165	A9407.7	A9417.7
	7.80	0.3071	109	165	A9407.8	A9417.8
5/16	7.90	0.3110	109	165	A9407.9	A9417.9
	7.94	0.3126	102	162	A9405/16	A9415/16
	8.00	0.3150	109	165	A9408.0	A9418.0
	8.10	0.3189	109	165	A9408.1	A9418.1
	8.20	0.3228	109	165	A9408.2	A9418.2
21/64	8.30	0.3268	109	165	A9408.3	A9418.3
	8.33	0.3280	105	165	A94021/64	A94121/64
	8.40	0.3307	109	165	A9408.4	A9418.4
	8.50	0.3346	109	165	A9408.5	A9418.5
	8.60	0.3386	115	175	A9408.6	A9418.6

d ₁ Øh ₈ Inch	d ₁ Øh ₈ mm	d ₁ decimal Inch	l ₂ mm	l ₁ mm	A940	A941
11/32	8.70	0.3425	115	175	A9408.7	A9418.7
	8.73	0.3437	105	165	A94011/32	A94111/32
	8.80	0.3465	115	175	A9408.8	A9418.8
	8.90	0.3504	115	175	A9408.9	A9418.9
	9.00	0.3543	115	175	A9409.0	A9419.0
23/64	9.10	0.3583	115	175	A9409.1	A9419.1
	9.13	0.3594	108	171	A94023/64	A94123/64
	9.20	0.3622	115	175	A9409.2	A9419.2
	9.30	0.3661	115	175	A9409.3	A9419.3
	9.40	0.3701	115	175	A9409.4	A9419.4
3/8	9.50	0.3740	115	175	A9409.5	A9419.5
	9.52	0.3748	108	171	A9403/8	A9413/8
	9.60	0.3780	121	184	A9409.6	A9419.6 ³⁾
	9.70	0.3819	121	184	A9409.7	A9419.7 ³⁾
	9.80	0.3858	121	184	A9409.8	A9419.8 ³⁾
25/64	9.90	0.3898	121	184	A9409.9	A9419.9 ³⁾
	9.92	0.3906	111	178	A94025/64	A94125/64 ³⁾
	10.00	0.3937	121	184	A94010.0	A94110.0 ³⁾
	10.20	0.4016	121	184	A94010.2	A94110.2 ³⁾
	10.30	0.4055	121	184	A94010.3	A94110.3 ³⁾
13/32	10.32	0.4063	111	178	A94013/32	A94113/32 ³⁾
	10.50	0.4134	121	184	A94010.5	A94110.5 ³⁾
27/64	10.72	0.4220	117	184	A94027/64	A94127/64 ³⁾
	11.00	0.4331	128	195	A94011.0	A94111.0 ³⁾
7/16	11.11	0.4374	117	184	A9407/16	A9417/16 ³⁾
	11.20	0.4409	128	195	A94011.2	A94111.2 ³⁾
29/64	11.50	0.4528	128	195	A94011.5	A94111.5 ³⁾
	11.51	0.4531	121	190	A94029/64	A94129/64 ³⁾
	11.80	0.4646	128	195	A94011.8	A94111.8 ³⁾
15/32	11.91	0.4689	121	190	A94015/32	A94115/32 ³⁾
	12.00	0.4724	134	205	A94012.0	A94112.0 ³⁾
31/64	12.20	0.4803	134	205	A94012.2	A94112.2 ³⁾
	12.30	0.4843	121	197	A94031/64	A94131/64 ³⁾
	12.50	0.4921	134	205	A94012.5	A94112.5 ³⁾
1/2	12.70	0.5000	121	197	A9401/2	A9411/2 ³⁾
33/64	13.00	0.5118	134	205	A94013.0	A94113.0 ³⁾
	13.10	0.5157	121	203	A94033/64	A94133/64 ³⁾
17/32	13.49	0.5311	121	203	A94017/32	
	13.50	0.5315	140	214	A94013.5	A94113.5 ³⁾
35/64	13.89	0.5469	124	210	A94035/64	A94135/64 ³⁾
	14.00	0.5512	140	214	A94014.0	A94114.0 ³⁾
9/16	14.29	0.5626	124	210	A9409/16	A9419/16 ³⁾
	14.50	0.5709	144	220	A94014.5	A94114.5 ³⁾
37/64	14.68	0.5780	124	222	A94037/64	A94137/64 ³⁾
	15.00	0.5906	144	220	A94015.0	A94115.0 ³⁾
19/32	15.08	0.5937	124	222	A94019/32	A94119/32 ³⁾
39/64	15.48	0.6094	124	222	A94039/64	A94139/64 ³⁾
	15.50	0.6102	149	227	A94015.5	A94115.5 ³⁾
5/8	15.88	0.6252	124	222	A9405/8	A9415/8 ³⁾
	16.00	0.6299	149	227	A94016.0	A94116.0 ³⁾
41/64	16.27	0.6406	130	229	A94041/64	
	16.50	0.6496	154	235	A94016.5	
21/32	16.67	0.6563	130	229	A94021/32	
	17.00	0.6693	154	235	A94017.0	
43/64	17.07	0.6720	137	235	A94043/64	
11/16	17.46	0.6874	137	235	A94011/16	
	17.50	0.6890	158	241	A94017.5	
45/64	17.86	0.7031	143	241	A94045/64	
	18.00	0.7087	158	241	A94018.0	
23/32	18.26	0.7189	143	241	A94023/32	
47/64	18.65	0.7343	149	248	A94047/64	
	19.00	0.7480	162	247	A94019.0	
3/4	19.05	0.7500	149	248	A9403/4	
49/64	19.45	0.7657	152	251	A94049/64	
25/32	19.84	0.7811	152	251	A94025/32	
	20.00	0.7874	166	254	A94020.0	

- A125**
- Vrtáky extra dlouhé
 - Спиральное сверло, сверхдлинное исполнение
 - Wiertło bardzo długie
 - Vrták extra dlhý
- Broušený povrch pod 2,2mm, 5/64"
 Менее 2,2 мм, 5/64" полированные
 Niepokrywane poniżej 2,2mm, 5/64
 Brúsený povrch pod 2,2mm, 5/64"

A125	▪	1.1	1.2																		
	•	1.3	1.4	1.5	1.6	2.1	2.2	2.3	3.1	3.2	3.3	3.4	4.1	4.2	4.3	5.1	5.2	5.3	6.1	6.2	6.3
		6.4	7.1	7.2	7.3	7.4	8.1	8.2	8.3	9.1											

A125

HSS

BS 328

10XD

118°

ST

N

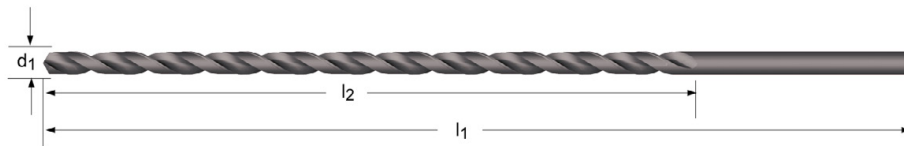

d_1 \varnothing_{h_8} Inch	d_1 \varnothing_{h_8} mm	d_1 decimal Inch	l_2 mm	l_1 mm	A125
	1.40	0.0551	100	160	A1251.4X160
	1.50	0.0591	80	125	A1251.5X125
	1.50	0.0591	100	160	A1251.5X160
1/16	1.59	0.0626	80	125	A1251/16X125
1/16	1.59	0.0626	100	160	A1251/16X160
	1.80	0.0709	100	160	A1251.8X160
5/64	1.98	0.0780	80	125	A1255/64X125
5/64	1.98	0.0780	100	160	A1255/64X160
	2.00	0.0787	80	125	A1252.0X125
	2.00	0.0787	100	160	A1252.0X160
	2.20	0.0866	100	160	A1252.2X160
3/32	2.38	0.0937	80	125	A1253/32X125
3/32	2.38	0.0937	100	160	A1253/32X160
	2.50	0.0984	80	125	A1252.5X125
	2.50	0.0984	100	160	A1252.5X160
7/64	2.78	0.1094	80	125	A1257/64X125
7/64	2.78	0.1094	100	160	A1257/64X160
	3.00	0.1181	100	160	A1253.0X160
	3.00	0.1181	150	200	A1253.0X200
	3.00	0.1181	200	250	A1253.0X250
1/8	3.18	0.1252	100	160	A1251/8X160
1/8	3.18	0.1252	150	200	A1251/8X200
1/8	3.18	0.1252	200	250	A1251/8X250
1/8	3.18	0.1252	250	310	A1251/8X315
	3.30	0.1299	100	160	A1253.3X160
	3.50	0.1378	100	160	A1253.5X160
	3.50	0.1378	150	200	A1253.5X200
	3.50	0.1378	200	250	A1253.5X250
9/64	3.57	0.1406	100	160	A1259/64X160
9/64	3.57	0.1406	150	200	A1259/64X200
9/64	3.57	0.1406	250	310	A1259/64X315
5/32	3.97	0.1563	100	160	A1255/32X160
5/32	3.97	0.1563	150	200	A1255/32X200
5/32	3.97	0.1563	200	250	A1255/32X250

d_1 $\varnothing h_8$ Inch	d_1 $\varnothing h_8$ mm	d_1 decimal inch	l_2 mm	l_1 mm	A125
5/32	3.97	0.1563	250	310	A1255/32X315
	4.00	0.1575	100	160	A1254.0X160
	4.00	0.1575	150	200	A1254.0X200
	4.00	0.1575	200	250	A1254.0X250
	4.00	0.1575	250	310	A1254.0X315
11/64	4.37	0.1720	100	160	A12511/64X160
11/64	4.37	0.1720	150	200	A12511/64X200
11/64	4.37	0.1720	250	310	A12511/64X315
	4.50	0.1772	100	160	A1254.5X160
	4.50	0.1772	150	200	A1254.5X200
	4.50	0.1772	200	250	A1254.5X250
	4.50	0.1772	250	310	A1254.5X315
3/16	4.76	0.1874	100	160	A1253/16X160
3/16	4.76	0.1874	150	200	A1253/16X200
3/16	4.76	0.1874	200	250	A1253/16X250
3/16	4.76	0.1874	250	310	A1253/16X315
3/16	4.76	0.1874	300	400	A1253/16X400
	5.00	0.1969	100	160	A1255.0X160
	5.00	0.1969	150	200	A1255.0X200
	5.00	0.1969	200	250	A1255.0X250
	5.00	0.1969	250	310	A1255.0X315
	5.00	0.1969	300	400	A1255.0X400
13/64	5.16	0.2031	150	200	A12513/64X200
13/64	5.16	0.2031	200	250	A12513/64X250
13/64	5.16	0.2031	250	310	A12513/64X315
	5.50	0.2165	150	200	A1255.5X200
	5.50	0.2165	200	250	A1255.5X250
	5.50	0.2165	250	310	A1255.5X315
7/32	5.56	0.2189	150	200	A1257/32X200
7/32	5.56	0.2189	200	250	A1257/32X250
7/32	5.56	0.2189	250	310	A1257/32X315
15/64	5.95	0.2343	150	200	A12515/64X200
15/64	5.95	0.2343	200	250	A12515/64X250
15/64	5.95	0.2343	250	310	A12515/64X315
	6.00	0.2362	150	200	A1256.0X200
	6.00	0.2362	200	250	A1256.0X250
	6.00	0.2362	250	310	A1256.0X315
	6.00	0.2362	300	400	A1256.0X400
1/4	6.35	0.2500	150	200	A1251/4X200
1/4	6.35	0.2500	200	250	A1251/4X250
1/4	6.35	0.2500	250	310	A1251/4X315
1/4	6.35	0.2500	300	400	A1251/4X400
1/4	6.35	0.2500	400	460	A1251/4X500
	6.50	0.2559	150	200	A1256.5X200
	6.50	0.2559	200	250	A1256.5X250
	6.50	0.2559	250	310	A1256.5X315
17/64	6.75	0.2657	150	200	A12517/64X200
17/64	6.75	0.2657	200	250	A12517/64X250
17/64	6.75	0.2657	400	460	A12517/64X500
	7.00	0.2756	150	200	A1257.0X200
	7.00	0.2756	200	250	A1257.0X250
	7.00	0.2756	250	310	A1257.0X315
9/32	7.14	0.2811	150	200	A1259/32X200
9/32	7.14	0.2811	200	250	A1259/32X250
9/32	7.14	0.2811	250	310	A1259/32X315
9/32	7.14	0.2811	400	460	A1259/32X500
	7.50	0.2953	150	200	A1257.5X200
	7.50	0.2953	200	250	A1257.5X250
	7.50	0.2953	250	310	A1257.5X315
19/64	7.54	0.2969	250	310	A12519/64X315
19/64	7.54	0.2969	400	460	A12519/64X500
5/16	7.94	0.3126	150	200	A1255/16X200
5/16	7.94	0.3126	200	250	A1255/16X250
5/16	7.94	0.3126	250	310	A1255/16X315
5/16	7.94	0.3126	300	400	A1255/16X400
5/16	7.94	0.3126	400	460	A1255/16X500
	8.00	0.3150	200	250	A1258.0X250
	8.00	0.3150	250	310	A1258.0X315
	8.00	0.3150	300	400	A1258.0X400
21/64	8.33	0.3280	250	310	A12521/64X315

d_1 $\varnothing h_8$ Inch	d_1 $\varnothing h_8$ mm	d_1 decimal Inch	l_2 mm	l_1 mm	A125
21/64	8.33	0.3280	400	460	A12521/64X500
	8.50	0.3346	200	250	A1258.5X250
	8.50	0.3346	250	310	A1258.5X315
11/32	8.73	0.3437	200	250	A12511/32X250
11/32	8.73	0.3437	250	310	A12511/32X315
11/32	8.73	0.3437	300	400	A12511/32X400
11/32	8.73	0.3437	400	460	A12511/32X500
	9.00	0.3543	200	250	A1259.0X250
	9.00	0.3543	250	310	A1259.0X315
	9.00	0.3543	300	400	A1259.0X400
23/64	9.13	0.3594	250	310	A12523/64X315
23/64	9.13	0.3594	400	460	A12523/64X500
	9.50	0.3740	200	250	A1259.5X250
	9.50	0.3740	250	310	A1259.5X315
3/8	9.52	0.3748	200	250	A1253/8X250
3/8	9.52	0.3748	250	310	A1253/8X315
3/8	9.52	0.3748	300	400	A1253/8X400
3/8	9.52	0.3748	400	460	A1253/8X500
25/64	9.92	0.3906	250	310	A12525/64X315
25/64	9.92	0.3906	400	460	A12525/64X500
	10.00	0.3937	200	250	A12510.0X250
	10.00	0.3937	250	310	A12510.0X315
	10.00	0.3937	300	400	A12510.0X400
13/32	10.32	0.4063	200	250	A12513/32X250
13/32	10.32	0.4063	250	310	A12513/32X315
13/32	10.32	0.4063	400	460	A12513/32X500
	10.50	0.4134	200	250	A12510.5X250
	10.50	0.4134	250	310	A12510.5X315
	10.50	0.4134	300	400	A12510.5X400
27/64	10.72	0.4220	250	310	A12527/64X315
	11.00	0.4331	200	250	A12511.0X250
	11.00	0.4331	250	310	A12511.0X315
	11.00	0.4331	300	400	A12511.0X400
7/16	11.11	0.4374	200	250	A1257/16X250
7/16	11.11	0.4374	250	310	A1257/16X315
7/16	11.11	0.4374	300	400	A1257/16X400
7/16	11.11	0.4374	400	460	A1257/16X500
29/64	11.51	0.4531	250	310	A12529/64X315
29/64	11.51	0.4531	400	460	A12529/64X500
15/32	11.91	0.4689	200	250	A12515/32X250
15/32	11.91	0.4689	250	310	A12515/32X315
15/32	11.91	0.4689	400	460	A12515/32X500
	12.00	0.4724	200	250	A12512.0X250
	12.00	0.4724	250	310	A12512.0X315
	12.00	0.4724	300	400	A12512.0X400
31/64	12.30	0.4843	250	310	A12531/64X315
31/64	12.30	0.4843	400	460	A12531/64X500
1/2	12.70	0.5000	200	250	A1251/2X250
1/2	12.70	0.5000	250	310	A1251/2X315
1/2	12.70	0.5000	300	400	A1251/2X400
1/2	12.70	0.5000	400	460	A1251/2X500
	13.00	0.5118	250	310	A12513.0X315
	13.00	0.5118	300	400	A12513.0X400
33/64	13.10	0.5157	250	310	A12533/64X315
33/64	13.10	0.5157	400	460	A12533/64X500
17/32	13.49	0.5311	250	310	A12517/32X315
17/32	13.49	0.5311	400	460	A12517/32X500
35/64	13.89	0.5469	250	310	A12535/64X315
35/64	13.89	0.5469	400	460	A12535/64X500
	14.00	0.5512	250	310	A12514.0X315
	14.00	0.5512	300	400	A12514.0X400
9/16	14.29	0.5626	250	310	A1259/16X315
9/16	14.29	0.5626	400	460	A1259/16X500
37/64	14.68	0.5780	250	310	A12537/64X315
19/32	15.08	0.5937	250	310	A12519/32X315
19/32	15.08	0.5937	400	460	A12519/32X500
39/64	15.48	0.6094	250	310	A12539/64X315
39/64	15.48	0.6094	400	460	A12539/64X500
5/8	15.88	0.6252	250	310	A1255/8X315
5/8	15.88	0.6252	400	460	A1255/8X500

d_1 $\varnothing h_8$ Inch	d_1 $\varnothing h_8$ mm	d_1 decimal Inch	l_2 mm	l_1 mm	A125
21/32	16.67	0.6563	250	310	A12521/32X315
21/32	16.67	0.6563	400	460	A12521/32X500
11/16	17.46	0.6874	250	310	A12511/16X315
11/16	17.46	0.6874	400	460	A12511/16X500
23/32	18.26	0.7189	250	310	A12523/32X315
23/32	18.26	0.7189	400	460	A12523/32X500
3/4	19.05	0.7500	250	310	A1253/4X315
3/4	19.05	0.7500	400	460	A1253/4X500
25/32	19.84	0.7811	400	460	A12525/32X500
13/16	20.64	0.8126	400	460	A12513/16X500
7/8	22.22	0.8748	400	460	A1257/8X500
15/16	23.81	0.9374	400	460	A12515/16X500
1"	25.40	1.0000	400	460	A1251X500

- A976** • PFX extra dlouhý vrták
- A977** • Спиральное сверло PFX, сверхдлинное исполнение
- A978** • Wiertło typu PFX, bardzo długie
- A978** • PFX extra dlhý vrták

A976; A977; A978	▪	1.3	1.4	1.5	1.6												
	•	1.1	1.2	2.1	2.2	2.3	3.2	3.3	3.4	4.1	4.2	4.3	6.3	6.4	7.4		

A976	HSS-E	DIN 1869/1	15XD	130°			W			
A977	HSS-E	DIN 1869/2	20XD	130°			W			
A978	HSS-E	DIN 1869/3	25XD	130°			W			

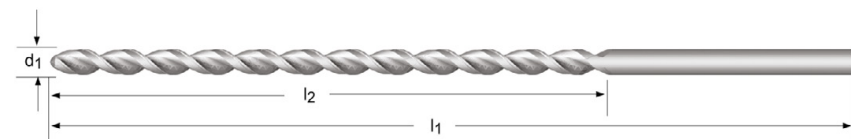

A976	A977	A978
PFX	PFX	PFX
1.50 - 14.00	1.50 - 14.00	3.00 - 10.00

d ₁ Øh ₈ Inch	d ₁ Øh ₈ mm	d ₁ decimal Inch	l ₂ mm	l ₁ mm	A976	A977	A978
	1.50	0.0591	75	115	A9761.5		
1/16	1.50	0.0591	100	150		A9771.5 ⁴⁾	
	1.59	0.0626	100	150		A9771/16 ⁴⁾	
	2.00	0.0787	110	160		A9772.0 ⁴⁾	
	2.00	0.0787	85	125	A9762.0X125		
3/32	2.10	0.0827	85	125	A9762.1X125		
	2.20	0.0866	90	135	A9762.2X135		
	2.30	0.0906	90	135	A9762.3X135		
	2.38	0.0937	115	170		A9773/32 ⁴⁾	
	2.40	0.0945	95	140	A9762.4X140		
	2.50	0.0984	95	140	A9762.5X140		
	2.60	0.1024	95	140	A9762.6X140		
	2.70	0.1063	100	150	A9762.7X150		
	2.80	0.1102	100	150	A9762.8X150		
	2.90	0.1142	100	150	A9762.9X150		
	3.00	0.1181	100	150	A9763.0X150		
	3.00	0.1181	130	190		A9773.0X190	
1/8	3.00	0.1181	160	240			A9783.0 ⁴⁾
	3.10	0.1220	105	155	A9763.1X155		
	3.18	0.1252	105	155	A9761/8		

⁴⁾ Dormer Standard / По стандарту Dormer / Standard Dormera / Dormer Standard

d_1 $\varnothing h_8$ Inch	d_1 $\varnothing h_8$ mm	d_1 decimal Inch	l_2 mm	l_1 mm	A976	A977	A978	
1/8	3.18	0.1252	135	200		A9771/8		
	3.20	0.1260	105	155	A9763.2X155			
	3.30	0.1299	105	155	A9763.3X155			
	3.40	0.1339	115	165	A9763.4X165			
	3.50	0.1378	115	165	A9763.5X165			
	3.50	0.1378	145	210		A9773.5X210		
	3.50	0.1378	180	265			A9783.5X265	
	3.60	0.1417	115	165	A9763.6X165			
	3.70	0.1457	115	165	A9763.7X165			
	3.80	0.1496	120	175	A9763.8X175			
5/32	3.90	0.1535	120	175	A9763.9X175			
	3.97	0.1563	120	175	A9765/32			
	4.00	0.1575	120	175	A9764.0X175			
	4.00	0.1575	150	220		A9774.0X220		
	4.00	0.1575	190	280			A9784.0X280	
	4.10	0.1614	120	175	A9764.1X175			
	4.20	0.1654	120	175	A9764.2X175			
	4.30	0.1693	125	185	A9764.3X185			
	4.40	0.1732	125	185	A9764.4X185			
	4.50	0.1772	125	185	A9764.5X185			
3/16	4.50	0.1772	160	235		A9774.5X235		
	4.50	0.1772	200	295			A9784.5X295	
	4.60	0.1811	125	185	A9764.6X185			
	4.70	0.1850	125	185	A9764.7X185			
	4.76	0.1874	135	195	A9763/16			
	3/16	4.76	0.1874	170	245		A9773/16	
		4.80	0.1890	135	195	A9764.8X195		
		4.90	0.1929	135	195	A9764.9X195		
		5.00	0.1969	135	195	A9765.0X195		
		5.00	0.1969	170	245		A9775.0X245	
5.00		0.1969	210	315			A9785.0X315	
5.10		0.2008	135	195	A9765.1X195			
5.20		0.2047	135	195	A9765.2X195			
5.30		0.2087	135	195	A9765.3X195			
5.40		0.2126	140	205	A9765.4X205			
1/4	5.50	0.2165	140	205	A9765.5X205			
	5.50	0.2165	180	260		A9775.5X260		
	5.50	0.2165	225	330			A9785.5X330	
	5.60	0.2205	140	205	A9765.6X205			
	5.70	0.2244	140	205	A9765.7X205			
	5.80	0.2283	140	205	A9765.8X205			
	5.90	0.2323	140	205	A9765.9X205			
	6.00	0.2362	140	205	A9766.0X205			
	6.00	0.2362	180	260		A9776.0X260		
	6.00	0.2362	225	330			A9786.0X330	
1/4	6.10	0.2402	150	215	A9766.1X215			
	6.20	0.2441	150	215	A9766.2X215			
	6.30	0.2480	150	215	A9766.3X215			
	6.35	0.2500	150	215	A9761/4			
	6.35	0.2500	190	275		A9771/4		
	6.35	0.2500	235	350			A9781/4	
	6.40	0.2520	150	215	A9766.4X215			
	6.50	0.2559	150	215	A9766.5X215			
	6.50	0.2559	190	275		A9776.5X275		
	6.50	0.2559	235	350			A9786.5X350	
1/4	6.60	0.2598	150	215	A9766.6X215			
	6.70	0.2638	150	215	A9766.7X215			
	6.80	0.2677	155	225	A9766.8X225			
	6.90	0.2717	155	225	A9766.9X225			
	7.00	0.2756	155	225	A9767.0X225			
	7.00	0.2756	200	290		A9777.0X290		
	7.00	0.2756	250	370			A9787.0X370	
	7.50	0.2953	155	225	A9767.5X225			
	7.50	0.2953	200	290		A9777.5X290		
	7.50	0.2953	250	370			A9787.5X370	
5/16	7.94	0.3126	165	240	A9765/16			
	8.00	0.3150	165	240	A9768.0X240			
	8.00	0.3150	210	305		A9778.0X305		
	8.00	0.3150	265	390			A9788.0X390	
	8.50	0.3346	165	240	A9768.5X240			

d_1 $\varnothing h_8$ Inch	d_1 $\varnothing h_8$ mm	d_1 decimal Inch	l_2 mm	l_1 mm	A976	A977	A978
	8.50	0.3346	210	305		A9778.5X305	
	8.50	0.3346	265	390			A9788.5X390
11/32	8.73	0.3437	175	250	A97611/32		
11/32	8.73	0.3437	220	320		A97711/32	
	9.00	0.3543	175	250	A9769.0X250		
	9.00	0.3543	220	320		A9779.0X320	
	9.00	0.3543	280	410			A9789.0X410
	9.50	0.3740	175	250	A9769.5X250		
	9.50	0.3740	220	320		A9779.5X320	
	9.50	0.3740	280	410			A9789.5X410
3/8	9.52	0.3748	185	265	A9763/8		
	10.00	0.3937	185	265	A97610.0X265		
	10.00	0.3937	235	340		A97710.0X340	
	10.00	0.3937	295	430			A97810.0X430
	10.50	0.4134	185	265	A97610.5		
	10.50	0.4134	235	340		A97710.5	
	11.00	0.4331	195	280	A97611.0		
	11.00	0.4331	250	365		A97711.0	
7/16	11.11	0.4374	195	280	A9767/16		
	11.50	0.4528	195	280	A97611.5		
	11.50	0.4528	250	365		A97711.5	
	12.00	0.4724	205	295	A97612.0		
	12.00	0.4724	260	375		A97712.0	
	12.50	0.4921	205	295	A97612.5		
	12.50	0.4921	260	375		A97712.5	
1/2	12.70	0.5000	205	295	A9761/2		
	13.00	0.5118	205	295	A97613.0		
	13.00	0.5118	260	375		A97713.0	
	14.00	0.5512	215	310	A97614.0		
	14.00	0.5512	270	390		A97714.0	

⁴⁾ Dormer Standard / По стандарту Dormer / Standard Dormera / Dormer Standard

- A130** • Vrtáky s kužel. stopkou nad 14,0 mm - bodbroušený vrchol
 • Спиральное сверло с конусом Морзе Более 14,0 мм - с подточкой вершины
- A530** • Wiertło z chwytem stożkowym Powyżej 14,0mm- pocieniony rdzeń
 • Vrták s kuželovou stopkou Nad 14,0mm - podbrúsený vrchol

- A730** • Vrtáky s kužel. stopkou
 • Спиральное сверло с конусом Морзе
 • Wiertło z chwytem stożkowym
 • Vrták s kuželovou stopkou

A130	▪	1.1	1.2	1.3	1.4	3.1	3.2														
	•	1.5	1.6	2.1	2.2	2.3	3.3	3.4	4.1	4.2	4.3	5.1	5.2	5.3	6.1	6.2	6.3	6.4	7.1	7.2	7.3
		7.4	8.1	8.2	8.3	9.1															
A530	▪	1.1	1.2	1.3	1.4	3.2	3.3	6.3													
	•	1.5	1.6	2.1	2.2	2.3	3.1	3.4	4.1	4.2	4.3	5.1	5.2	5.3	6.1	6.2	6.4	7.1	7.2	7.3	7.4
		8.1	8.2	8.3	9.1																
A730	▪	1.5	1.6	2.2	2.3	3.4															
	•	1.1	1.2	1.3	1.4	2.1	3.1	3.2	3.3	4.1	4.2	4.3	5.1	5.2	5.3	6.1	6.2	6.3	6.4	7.1	7.2
		7.3	7.4	8.1	8.2	8.3	9.1														

A130	HSS	DIN 345	4XD	118°	ST		N			
A530	HSS	DIN 345	4XD	118°	TiN		N			
A730	HSS-E	DIN 345	4XD	118°	Bronze		N			

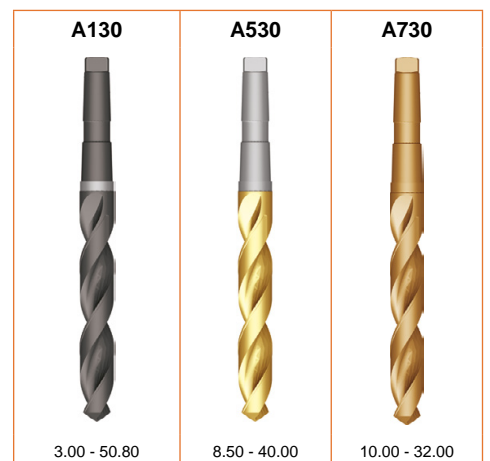
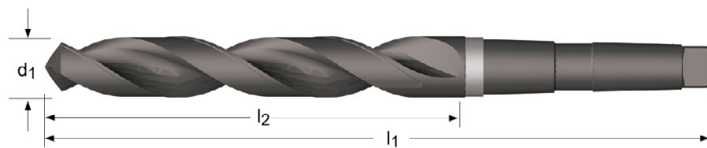

d_1 Øh ₈ Inch	d_1 Øh ₈ mm	d_1 decimal Inch	l_2 mm	l_1 mm	MK	A130	A530	A730
	3.00	0.1181	33	114	1	A1303.0		
1/8	3.18	0.1252	36	117	1	A1301/8		
	3.20	0.1260	36	117	1	A1303.2		
	3.25	0.1280	36	117	1	A1303.25		
	3.30	0.1299	36	117	1	A1303.3		
	3.50	0.1378	39	120	1	A1303.5		
9/64	3.57	0.1406	39	120	1	A1309/64		
	3.75	0.1476	39	120	1	A1303.75		
5/32	3.97	0.1563	43	124	1	A1305/32		
	4.00	0.1575	43	124	1	A1304.0		
	4.10	0.1614	43	124	1	A1304.1		
	4.20	0.1654	43	124	1	A1304.2		

d_1 $\varnothing h_8$ Inch	d_1 $\varnothing h_8$ mm	d_1 decimal Inch	l_2 mm	l_1 mm	MK	A130	A530	A730
11/64	4.25	0.1673	43	124	1	A1304.25		
	4.37	0.1720	47	128	1	A13011/64		
	4.50	0.1772	47	128	1	A1304.5		
3/16	4.75	0.1870	52	128	1	A1304.75		
	4.76	0.1874	52	133	1	A1303/16		
	4.80	0.1890	52	133	1	A1304.8		
	4.90	0.1929	52	133	1	A1304.9		
	5.00	0.1969	52	133	1	A1305.0		
13/64	5.10	0.2008	52	133	1	A1305.1		
	5.16	0.2031	52	133	1	A13013/64		
	5.20	0.2047	52	133	1	A1305.2		
	5.25	0.2067	52	133	1	A1305.25		
	5.40	0.2126	57	138	1	A1305.4		
7/32	5.50	0.2165	57	138	1	A1305.5		
	5.56	0.2189	57	138	1	A1307/32		
	5.70	0.2244	57	138	1	A1305.7		
	5.75	0.2264	57	138	1	A1305.75		
	5.80	0.2283	57	138	1	A1305.8		
15/64	5.90	0.2323	57	138	1	A1305.9		
	5.95	0.2343	57	138	1	A13015/64		
	6.00	0.2362	57	138	1	A1306.0		
	6.10	0.2402	63	144	1	A1306.1		
	6.20	0.2441	63	144	1	A1306.2		
1/4	6.25	0.2461	63	144	1	A1306.25		
	6.30	0.2480	63	144	1	A1306.3		
	6.35	0.2500	63	144	1	A1301/4		
	6.40	0.2520	63	144	1	A1306.4		
	6.50	0.2559	63	144	1	A1306.5		
17/64	6.60	0.2598	63	144	1	A1306.6		
	6.70	0.2638	63	144	1	A1306.7		
	6.75	0.2657	69	150	1	A13017/64		
	6.75	0.2657	69	150	1	A1306.75		
	6.80	0.2677	69	150	1	A1306.8		
9/32	6.90	0.2717	69	150	1	A1306.9		
	7.00	0.2756	69	150	1	A1307.0		
	7.14	0.2811	69	150	1	A1309/32		
	7.20	0.2835	69	150	1	A1307.2		
	7.25	0.2854	69	150	1	A1307.25		
19/64	7.30	0.2874	69	150	1	A1307.3		
	7.40	0.2913	69	150	1	A1307.4		
	7.50	0.2953	69	150	1	A1307.5		
	7.54	0.2969	75	156	1	A13019/64		
	7.70	0.3031	75	156	1	A1307.7		
5/16	7.75	0.3051	75	156	1	A1307.75		
	7.80	0.3071	75	156	1	A1307.8		
	7.90	0.3110	75	156	1	A1307.9		
	7.94	0.3126	75	156	1	A1305/16		
	8.00	0.3150	75	156	1	A1308.0		
21/64	8.10	0.3189	75	156	1	A1308.1		
	8.20	0.3228	75	156	1	A1308.2		
	8.25	0.3248	75	156	1	A1308.25		
	8.30	0.3268	75	156	1	A1308.3		
	8.33	0.3280	75	156	1	A13021/64		
11/32	8.40	0.3307	75	156	1	A1308.4		
	8.50	0.3346	75	156	1	A1308.5	A5308.5	
	8.60	0.3386	81	162	1	A1308.6		
	8.70	0.3425	81	162	1	A1308.7		
	8.73	0.3437	81	162	1	A13011/32		
23/64	8.75	0.3445	81	162	1	A1308.75		
	8.80	0.3465	81	162	1	A1308.8		
	8.90	0.3504	81	162	1	A1308.9		
	9.00	0.3543	81	162	1	A1309.0	A5309.0	
	9.10	0.3583	81	162	1	A1309.1		
3/8	9.13	0.3594	81	162	1	A13023/64		
	9.20	0.3622	81	162	1	A1309.2		
	9.25	0.3642	81	162	1	A1309.25		
	9.30	0.3661	81	162	1	A1309.3		
	9.50	0.3740	81	162	1	A1309.5		
3/8	9.52	0.3748	87	168	1	A1303/8		
	9.60	0.3780	87	168	1	A1309.6		

d ₁ Øh ₈ Inch	d ₁ Øh ₈ mm	d ₁ decimal Inch	l ₂ mm	l ₁ mm	MK	A130	A530	A730
	9.70	0.3819	87	168	1	A1309.7		
	9.75	0.3839	87	168	1	A1309.75		
	9.80	0.3858	87	168	1	A1309.8		
	9.90	0.3898	87	168	1	A1309.9		
25/64	9.92	0.3906	87	168	1	A13025/64		
	10.00	0.3937	87	168	1	A13010.0	A53010.0	A73010.0
	10.10	0.3976	87	168	1	A13010.1		
	10.20	0.4016	87	168	1	A13010.2	A53010.2	A73010.2
	10.25	0.4035	87	168	1	A13010.25		
	10.30	0.4055	87	168	1	A13010.3		
13/32	10.32	0.4063	87	168	1	A13013/32		
	10.50	0.4134	87	168	1	A13010.5	A53010.5	A73010.5
27/64	10.72	0.4220	94	175	1	A13027/64		
	10.75	0.4232	94	175	1	A13010.75		
	10.80	0.4252	94	175	1	A13010.8		A73010.8
	10.90	0.4291	94	175	1	A13010.9		
	11.00	0.4331	94	175	1	A13011.0	A53011.0	A73011.0
	11.10	0.4370	94	175	1	A13011.1		
7/16	11.11	0.4374	94	175	1	A1307/16		
	11.20	0.4409	94	175	1	A13011.2		
	11.25	0.4429	94	175	1	A13011.25		
	11.30	0.4449	94	175	1	A13011.3		
	11.40	0.4488	94	175	1	A13011.4		
	11.50	0.4528	94	175	1	A13011.5	A53011.5	A73011.5
29/64	11.51	0.4531	94	175	1	A13029/64		
	11.60	0.4567	94	175	1	A13011.6		
	11.70	0.4606	94	175	1	A13011.7		
	11.75	0.4626	94	175	1	A13011.75	A53011.75	
	11.80	0.4646	94	175	1	A13011.8		A73011.8
	11.90	0.4685	101	182	1	A13011.9		
15/32	11.91	0.4689	101	182	1	A13015/32		
	12.00	0.4724	101	182	1	A13012.0	A53012.0	A73012.0
	12.10	0.4764	101	182	1	A13012.1		
	12.20	0.4803	101	182	1	A13012.2		A73012.2
	12.25	0.4823	101	182	1	A13012.25		
	12.30	0.4843	101	182	1	A13012.3		
31/64	12.30	0.4843	101	182	1	A13031/64		
	12.40	0.4882	101	182	1	A13012.4		
	12.50	0.4921	101	182	1	A13012.5	A53012.5	A73012.5
	12.60	0.4961	101	182	1	A13012.6		
	12.70	0.5000	101	182	1	A13012.7		
1/2	12.70	0.5000	101	182	1	A1301/2		
	12.75	0.5020	101	182	1	A13012.75		
	12.80	0.5039	101	182	1	A13012.8		A73012.8
	12.90	0.5079	101	182	1	A13012.9		
	13.00	0.5118	101	182	1	A13013.0	A53013.0	A73013.0
33/64	13.10	0.5157	101	182	1	A13033/64		
	13.20	0.5197	101	182	1	A13013.2		
	13.25	0.5217	108	189	1	A13013.25		
17/32	13.49	0.5311	108	189	1	A13017/32		
	13.50	0.5315	108	189	1	A13013.5	A53013.5	A73013.5
	13.60	0.5354	108	189	1	A13013.6		
	13.70	0.5394	108	189	1	A13013.7		
	13.75	0.5413	108	189	1	A13013.75		
	13.80	0.5433	108	189	1	A13013.8		A73013.8
35/64	13.89	0.5469	108	189	1	A13035/64		
	13.90	0.5472	108	189	1	A13013.9		
	14.00	0.5512	108	189	1	A13014.0	A53014.0	A73014.0
	14.10	0.5551	114	212	2	A13014.1		
	14.20	0.5591	114	212	2	A13014.2		
	14.25	0.5610	114	212	2	A13014.25		A73014.25
9/16	14.29	0.5626	114	212	2	A1309/16		
	14.30	0.5630	114	212	2	A13014.3		
	14.40	0.5669	114	212	2	A13014.4		
	14.50	0.5709	114	212	2	A13014.5	A53014.5	A73014.5
	14.60	0.5748	114	212	2	A13014.6		
37/64	14.68	0.5780	114	212	2	A13037/64		
	14.70	0.5787	114	212	2	A13014.7		
	14.75	0.5807	114	212	2	A13014.75		A73014.75
	14.80	0.5827	114	212	2	A13014.8		

d_1 \varnothing_{h_8} Inch	d_1 \varnothing_{h_8} mm	d_1 decimal Inch	l_2 mm	l_1 mm	MK	A130	A530	A730
	14.90	0.5866	114	212	2	A13014.9		
19/32	15.00	0.5906	114	212	2	A13015.0	A53015.0	A73015.0
	15.08	0.5937	120	218	2	A13019/32		
	15.10	0.5945	120	218	2	A13015.1		
	15.20	0.5984	120	218	2	A13015.2		
39/64	15.25	0.6004	120	218	2	A13015.25	A53015.25	A73015.25
	15.48	0.6094	120	218	2	A13039/64		
	15.50	0.6102	120	218	2	A13015.5	A53015.5	A73015.5
	15.70	0.6181	120	218	2	A13015.7		
5/8	15.75	0.6201	120	218	2	A13015.75		A73015.75
	15.80	0.6220	120	218	2	A13015.8		
	15.88	0.6252	120	218	2	A1305/8		
	15.90	0.6260	120	218	2	A13015.9		
	16.00	0.6299	120	218	2	A13016.0	A53016.0	A73016.0
	16.10	0.6339	125	223	2	A13016.1		
	16.20	0.6378	125	223	2	A13016.2		
	16.25	0.6398	120	218	2			A73016.25
41/64	16.25	0.6398	125	223	2	A13016.25		
	16.27	0.6406	125	223	2	A13041/64		
	16.50	0.6496	125	223	2	A13016.5	A53016.5	A73016.5
21/32	16.67	0.6563	125	223	2	A13021/32		
	16.75	0.6594	125	223	2	A13016.75		
43/64	17.00	0.6693	125	223	2	A13017.0	A53017.0	A73017.0
	17.07	0.6720	130	228	2	A13043/64		
	17.25	0.6791	130	228	2	A13017.25		A73017.25
11/16	17.46	0.6874	130	228	2	A13011/16		
	17.50	0.6890	130	228	2	A13017.5	A53017.5	A73017.5
	17.75	0.6988	130	228	2	A13017.75		A73017.75
45/64	17.86	0.7031	130	228	2	A13045/64		
	18.00	0.7087	130	228	2	A13018.0	A53018.0	A73018.0
	18.25	0.7185	135	233	2	A13018.25		A73018.25
23/32	18.26	0.7189	135	233	2	A13023/32		
	18.50	0.7283	135	233	2	A13018.5	A53018.5	A73018.5
47/64	18.65	0.7343	135	233	2	A13047/64		
	18.75	0.7382	135	233	2	A13018.75		A73018.75
	19.00	0.7480	135	233	2	A13019.0	A53019.0	A73019.0
3/4	19.05	0.7500	140	238	2	A1303/4		
	19.25	0.7579	140	238	2	A13019.25		A73019.25
	19.45	0.7657	140	238	2	A13049/64		
49/64	19.50	0.7677	140	238	2	A13019.5	A53019.5	A73019.5
	19.75	0.7776	140	238	2	A13019.75		A73019.75
	19.84	0.7811	140	238	2	A13025/32		
	20.00	0.7874	140	238	2	A13020.0	A53020.0	A73020.0
51/64	20.24	0.7969	145	243	2	A13051/64		
	20.25	0.7972	145	243	2	A13020.25		A73020.25
	20.40	0.8031	145	243	2	A13020.4		
	20.50	0.8071	145	243	2	A13020.5	A53020.5	A73020.5
13/16	20.64	0.8126	145	243	2	A13013/16		
	20.75	0.8169	145	243	2	A13020.75		A73020.75
	21.00	0.8268	145	243	2	A13021.0	A53021.0	A73021.0
53/64	21.03	0.8280	145	243	2	A13053/64		
	21.25	0.8366	150	248	2	A13021.25		
	21.43	0.8437	150	248	2	A13027/32		
27/32	21.50	0.8465	150	248	2	A13021.5	A53021.5	A73021.5
	21.75	0.8563	150	248	2	A13021.75		
	21.83	0.8594	150	248	2	A13055/64		
	22.00	0.8661	150	248	2	A13022.0	A53022.0	A73022.0
7/8	22.22	0.8748	150	248	2	A1307/8		
	22.25	0.8760	150	248	2	A13022.25		
	22.50	0.8858	155	253	2	A13022.5	A53022.5	A73022.5
57/64	22.62	0.8906	155	253	2	A13057/64		
	22.75	0.8957	155	253	2	A13022.75		
	23.00	0.9055	155	253	2	A13023.0	A53023.0	A73023.0
29/32	23.02	0.9063	155	253	2	A13029/32		
	23.25	0.9154	155	276	3	A13023.25		
59/64	23.42	0.9220	155	276	3	A13059/64		
	23.50	0.9252	155	276	3	A13023.5	A53023.5	A73023.5
	23.75	0.9350	160	281	3	A13023.75		
15/16	23.81	0.9374	160	281	3	A13015/16		
	24.00	0.9449	160	281	3	A13024.0	A53024.0	A73024.0

d_1 $\varnothing_{\frac{1}{8}}$ Inch	d_1 $\varnothing_{\frac{1}{8}}$ mm	d_1 decimal Inch	l_2 mm	l_1 mm	MK	A130	A530	A730
61/64	24.21	0.9531	160	281	3	A13061/64		
	24.25	0.9547	160	281	3	A13024.25		
	24.50	0.9646	160	281	3	A13024.5	A53024.5	A73024.5
31/32	24.61	0.9689	160	281	3	A13031/32		
	24.75	0.9744	160	281	3	A13024.75		
	25.00	0.9843	160	281	3	A13025.0	A53025.0	A73025.0
63/64	25.00	0.9843	160	286	3	A13063/64		
	25.25	0.9941	165	286	3	A13025.25		
1"	25.40	1.0000	165	286	3	A1301		
	25.50	1.0039	165	286	3	A13025.5	A53025.5	A73025.5
	25.75	1.0138	165	286	3	A13025.75		
	26.00	1.0236	165	286	3	A13026.0	A53026.0	A73026.0
	26.25	1.0335	165	286	3	A13026.25		
	26.50	1.0433	165	286	3	A13026.5	A53026.5	A73026.5
	26.75	1.0531	170	291	3	A13026.75		
	26.99	1.0626	170	291	3	A1301.1/16		
1.1/16	27.00	1.0630	170	291	3	A13027.0	A53027.0	A73027.0
	27.25	1.0728	170	291	3	A13027.25		
	27.50	1.0827	170	291	3	A13027.5	A53027.5	A73027.5
	27.75	1.0925	170	291	3	A13027.75		
	28.00	1.1024	170	291	3	A13028.0	A53028.0	A73028.0
	28.25	1.1122	175	296	3	A13028.25		
	28.50	1.1220	175	296	3	A13028.5	A53028.5	A73028.5
	28.58	1.1252	175	296	3	A1301.1/8		
1.1/8	28.75	1.1319	175	296	3	A13028.75		
	29.00	1.1417	175	296	3	A13029.0	A53029.0	A73029.0
	29.25	1.1516	175	296	3	A13029.25		
	29.37	1.1563	175	296	3	A1301.5/32		
1.5/32	29.50	1.1614	175	296	3	A13029.5	A53029.5	
	29.75	1.1713	175	296	3	A13029.75		
	30.00	1.1811	175	296	3	A13030.0	A53030.0	A73030.0
	30.16	1.1874	180	301	3	A1301.3/16		
1.3/16	30.25	1.1909	180	301	3	A13030.25		
	30.50	1.2008	180	301	3	A13030.5		
	30.75	1.2106	180	301	3	A13030.75		
	30.96	1.2189	180	301	3	A1301.7/32		
	31.00	1.2205	180	301	3	A13031.0	A53031.0	A73031.0
1.7/32	31.25	1.2303	180	301	3	A13031.25		
	31.50	1.2402	180	301	3	A13031.5		
	31.75	1.2500	185	306	3	A13031.75		
	31.75	1.2500	185	306	3	A1301.1/4		
	32.00	1.2598	185	334	4	A13032.0	A53032.0	A73032.0
1.1/4	32.50	1.2795	185	334	4	A13032.5		
	32.54	1.2811	185	334	4	A1301.9/32		
	33.00	1.2992	185	334	4	A13033.0	A53033.0	
1.9/32	33.34	1.3126	185	334	4	A1301.5/16		
	33.50	1.3189	185	334	4	A13033.5		
	34.00	1.3386	190	339	4	A13034.0		
1.11/32	34.13	1.3437	190	339	4	A1301.11/32		
	34.50	1.3583	190	339	4	A13034.5		
	34.93	1.3752	190	339	4	A1301.3/8		
1.3/8	35.00	1.3780	190	339	4	A13035.0	A53035.0	
	35.50	1.3976	190	339	4	A13035.5		
	35.72	1.4063	195	344	4	A1301.13/32		
1.13/32	36.00	1.4173	195	344	4	A13036.0		
	36.50	1.4370	195	344	4	A13036.5		
	36.51	1.4374	195	344	4	A1301.7/16		
	37.00	1.4567	195	344	4	A13037.0		
1.7/16	37.50	1.4764	195	344	4	A13037.5		
	38.00	1.4961	200	349	4	A13038.0		
	38.10	1.5000	200	349	4	A1301.1/2		
	38.50	1.5157	200	349	4	A13038.5		
	39.00	1.5354	200	349	4	A13039.0		
1.9/16	39.50	1.5551	200	349	4	A13039.5		
	39.69	1.5626	200	349	4	A1301.9/16		
	40.00	1.5748	200	349	4	A13040.0	A53040.0	
	40.50	1.5945	205	354	4	A13040.5		
	41.00	1.6142	205	354	4	A13041.0		
1.5/8	41.28	1.6252	205	354	4	A1301.5/8		
	41.50	1.6339	205	354	4	A13041.5		

d_1 $\varnothing h_8$ Inch	d_1 $\varnothing h_8$ mm	d_1 decimal Inch	l_2 mm	l_1 mm	MK	A130	A530	A730
	42.00	1.6535	205	354	4	A13042.0		
	42.50	1.6732	205	354	4	A13042.5		
1.11/16	42.86	1.6874	210	359	4	A1301.11/16		
	43.00	1.6929	210	359	4	A13043.0		
	43.50	1.7126	210	359	4	A13043.5		
	44.00	1.7323	210	359	4	A13044.0		
1.3/4	44.45	1.7500	210	359	4	A1301.3/4		
	44.50	1.7520	210	359	4	A13044.5		
	45.00	1.7717	210	359	4	A13045.0		
	45.50	1.7913	215	364	4	A13045.5		
	46.00	1.8110	215	364	4	A13046.0		
	46.50	1.8307	215	364	4	A13046.5		
	47.00	1.8504	215	364	4	A13047.0		
	47.50	1.8701	215	364	4	A13047.5		
	48.00	1.8898	220	369	4	A13048.0		
	48.50	1.9094	220	369	4	A13048.5		
	49.00	1.9291	220	369	4	A13049.0		
	49.50	1.9488	220	369	4	A13049.5		
	50.00	1.9685	220	369	4	A13050.0		
2"	50.80	2.0000	225	374	4	A1302		

- # A166
- Vrták na MK, naletovaná karbidová špička, 4 fazety
 - Сверло с 4-х гранной заточкой и напайной т/с пластиной, конический хвостовик
 - Wiertło z chwytem stożkowym z 4 płaszczyznowym ostrzem z wlutowaną płytką węglkową
 - Vrták na MK, naletovaná karbidová špička, 4 fazety

A166	▪	3.1	3.2	3.3	3.4																
	•	1.1	1.2	1.3	1.4	1.5	1.6	2.1	2.2	2.3	4.1	4.2	4.3	5.1	5.2	5.3	6.1	6.2	6.3	6.4	7.1
		7.2	7.3	7.4	8.2	9.1															

A166 **HSS HM** **DIN 345** **4XD** **118°** **ST** **N**



d_1 \varnothing_{h_8} mm	d_1 decimal Inch	l_2 mm	l_1 mm	MK	A166
10.00	0.3937	87	168	1	A16610.0
10.50	0.4134	87	168	1	A16610.5
11.00	0.4331	94	175	1	A16611.0
11.50	0.4528	94	175	1	A16611.5
12.00	0.4724	101	182	1	A16612.0
13.00	0.5118	101	182	1	A16613.0
13.50	0.5315	108	189	1	A16613.5
14.00	0.5512	108	189	1	A16614.0
15.00	0.5906	114	212	2	A16615.0
16.00	0.6299	120	218	2	A16616.0
17.00	0.6693	125	223	2	A16617.0
17.50	0.6890	130	228	2	A16617.5
18.00	0.7087	130	228	2	A16618.0
19.00	0.7480	135	233	2	A16619.0
20.00	0.7874	140	238	2	A16620.0
21.00	0.8268	145	243	2	A16621.0
22.00	0.8661	150	248	2	A16622.0
22.50	0.8858	155	253	2	A16622.5
23.00	0.9055	155	253	2	A16623.0
24.00	0.9449	160	281	3	A16624.0
25.00	0.9843	160	281	3	A16625.0
26.00	1.0236	165	286	3	A16626.0
27.00	1.0630	170	291	3	A16627.0
28.00	1.1024	170	291	3	A16628.0
29.00	1.1417	175	296	3	A16629.0
30.00	1.1811	175	296	3	A16630.0
32.00	1.2598	185	334	4	A16632.0
33.00	1.2992	185	334	4	A16633.0

- A350**
- Vrtáky dlouhé
 - Спиральное сверло, длинное исполнение, с коническим хвостовиком
 - Wiertło długie z chwytem stożkowym
 - Vrták dlhý

A350	▪	1.1	1.2																		
	•	1.3	1.4	1.5	1.6	2.1	2.2	2.3	3.1	3.2	3.3	3.4	4.1	4.2	4.3	5.1	5.2	5.3	6.1	6.2	6.3
		6.4	7.1	7.2	7.3	7.4	8.1	8.2	8.3	9.1											

A350 HSS DIN 341 6XD 118° ST N

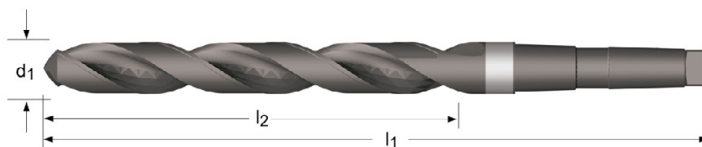

d_1 $\varnothing h_8$ mm	d_1 decimal Inch	l_2 mm	l_1 mm	MK	A350
5.00	0.1969	74	155	1	A3505.0
5.50	0.2165	80	161	1	A3505.5
6.00	0.2362	80	161	1	A3506.0
6.70	0.2638	86	167	1	A3506.7
6.80	0.2677	93	174	1	A3506.8
7.00	0.2756	93	174	1	A3507.0
7.50	0.2953	93	174	1	A3507.5
8.00	0.3150	100	181	1	A3508.0
8.40	0.3307	100	181	1	A3508.4
8.50	0.3346	100	181	1	A3508.5
8.75	0.3445	107	188	1	A3508.75
9.00	0.3543	107	188	1	A3509.0
9.50	0.3740	107	188	1	A3509.5
9.80	0.3858	116	197	1	A3509.8
10.00	0.3937	116	197	1	A35010.0
10.20	0.4016	116	197	1	A35010.2
10.50	0.4134	116	197	1	A35010.5
10.70	0.4213	125	206	1	A35010.7
11.00	0.4331	125	206	1	A35011.0
11.50	0.4528	125	206	1	A35011.5
11.75	0.4626	125	206	1	A35011.75
11.80	0.4646	125	206	1	A35011.8
12.00	0.4724	134	215	1	A35012.0
12.50	0.4921	134	215	1	A35012.5
13.00	0.5118	134	215	1	A35013.0
13.50	0.5315	142	223	1	A35013.5
14.00	0.5512	142	223	1	A35014.0
14.25	0.5610	147	245	2	A35014.25
14.50	0.5709	147	245	2	A35014.5
14.75	0.5807	147	245	2	A35014.75
15.00	0.5906	147	245	2	A35015.0
15.25	0.6004	153	251	2	A35015.25
15.50	0.6102	153	251	2	A35015.5
15.75	0.6201	153	251	2	A35015.75

d_1 $\varnothing h_8$ mm	d_1 decimal Inch	l_2 mm	l_1 mm	MK	A350
16.00	0.6299	153	251	2	A35016.0
16.25	0.6398	159	257	2	A35016.25
16.50	0.6496	159	257	2	A35016.5
16.75	0.6594	159	257	2	A35016.75
17.00	0.6693	159	257	2	A35017.0
17.25	0.6791	165	263	2	A35017.25
17.50	0.6890	165	263	2	A35017.5
18.00	0.7087	165	263	2	A35018.0
18.50	0.7283	171	269	2	A35018.5
19.00	0.7480	171	269	2	A35019.0
19.50	0.7677	177	275	2	A35019.5
19.75	0.7776	177	275	2	A35019.75
20.00	0.7874	177	275	2	A35020.0
20.25	0.7972	184	282	2	A35020.25
20.50	0.8071	184	282	2	A35020.5
21.00	0.8268	184	282	2	A35021.0
21.50	0.8465	191	289	2	A35021.5
22.00	0.8661	191	289	2	A35022.0
22.50	0.8858	198	296	2	A35022.5
23.00	0.9055	198	296	2	A35023.0
23.50	0.9252	198	319	3	A35023.5
24.00	0.9449	206	327	3	A35024.0
24.50	0.9646	206	327	3	A35024.5
25.00	0.9843	206	327	3	A35025.0
25.50	1.0039	214	335	3	A35025.5
26.00	1.0236	214	335	3	A35026.0
26.50	1.0433	214	335	3	A35026.5
27.00	1.0630	222	343	3	A35027.0
27.50	1.0827	222	343	3	A35027.5
28.00	1.1024	222	343	3	A35028.0
29.00	1.1417	230	351	3	A35029.0
30.00	1.1811	230	351	3	A35030.0
30.50	1.2008	239	360	3	A35030.5
31.00	1.2205	239	360	3	A35031.0
31.50	1.2402	239	360	3	A35031.5
32.00	1.2598	248	397	4	A35032.0
33.00	1.2992	248	397	4	A35033.0
34.00	1.3386	257	406	4	A35034.0
35.00	1.3780	257	406	4	A35035.0
36.00	1.4173	267	416	4	A35036.0
37.00	1.4567	267	416	4	A35037.0
38.00	1.4961	277	426	4	A35038.0
39.00	1.5354	277	426	4	A35039.0
40.00	1.5748	277	426	4	A35040.0
41.00	1.6142	287	436	4	A35041.0
42.00	1.6535	287	436	4	A35042.0
43.00	1.6929	298	447	4	A35043.0
44.00	1.7323	298	447	4	A35044.0
45.00	1.7717	298	447	4	A35045.0
46.00	1.8110	310	459	4	A35046.0
47.00	1.8504	310	459	4	A35047.0
48.00	1.8898	321	470	4	A35048.0
50.00	1.9685	321	470	4	A35050.0

A345

- Vrták s kužel. stopkou, extra dlouhý
- Спиральное сверло с конусом Морзе, сверхдлинное исполнение
- Wiertło bardzo długie z chwytem Morse'a
- Vrták s kuželovou stopkou, extra dlhý

A345	▪	1.1	1.2																		
	•	1.3	1.4	1.5	1.6	2.1	2.2	2.3	3.1	3.2	3.3	3.4	4.1	4.2	4.3	5.1	5.2	5.3	6.1	6.2	6.3
		6.4	7.1	7.2	7.3	7.4	8.1	8.2	8.3	9.1											

A345

HSS

DIN
1870/1

10XD

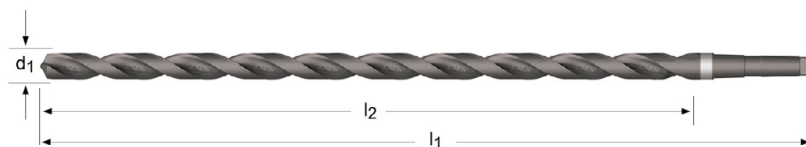

A345



8.00 - 40.00

d_1 \varnothing_{h_8} Inch	d_1 \varnothing_{h_8} mm	d_1 decimal Inch	l_2 mm	l_1 mm	MK	A345
	8.00	0.3150	165	265	1	A3458.0
	8.50	0.3346	165	265	1	A3458.5
	9.00	0.3543	175	275	1	A3459.0
	9.50	0.3740	175	275	1	A3459.5
3/8	9.52	0.3748	185	285	1	A3453/8
	10.00	0.3937	185	285	1	A34510.0
13/32	10.32	0.4063	185	285	1	A34513/32
	10.50	0.4134	185	285	1	A34510.5
	11.00	0.4331	195	300	1	A34511.0
7/16	11.11	0.4374	195	300	1	A3457/16
	11.50	0.4528	195	300	1	A34511.5
29/64	11.51	0.4531	205	310	1	A34529/64
	12.00	0.4724	205	310	1	A34512.0
	12.50	0.4921	205	310	1	A34512.5
1/2	12.70	0.5000	205	310	1	A3451/2
	13.00	0.5118	205	310	1	A34513.0
17/32	13.49	0.5311	220	325	1	A34517/32
	13.50	0.5315	220	325	1	A34513.5
	14.00	0.5512	220	325	1	A34514.0
9/16	14.29	0.5626	220	340	2	A3459/16
37/64	14.68	0.5780	220	340	2	A34537/64
	15.00	0.5906	220	340	2	A34515.0
39/64	15.48	0.6094	230	355	2	A34539/64
	15.50	0.6102	230	355	2	A34515.5
5/8	15.88	0.6252	230	355	2	A3455/8
	16.00	0.6299	230	355	2	A34516.0
41/64	16.27	0.6406	230	355	2	A34541/64
	16.50	0.6496	230	355	2	A34516.5
21/32	16.67	0.6563	230	355	2	A34521/32
	17.00	0.6693	230	355	2	A34517.0
11/16	17.46	0.6874	245	370	2	A34511/16
	17.50	0.6890	245	370	2	A34517.5

d_1 $\varnothing h_8$ Inch	d_1 $\varnothing h_8$ mm	d_1 decimal Inch	l_2 mm	l_1 mm	MK	A345	
3/4	18.00	0.7087	245	370	2	A34518.0	
	18.50	0.7283	245	370	2	A34518.5	
	19.00	0.7480	245	370	2	A34519.0	
	19.05	0.7500	260	385	2	A3453/4	
	19.50	0.7677	260	385	2	A34519.5	
	20.00	0.7874	260	385	2	A34520.0	
	20.50	0.8071	260	385	2	A34520.5	
	21.00	0.8268	260	385	2	A34521.0	
	21.50	0.8465	270	405	2	A34521.5	
	22.00	0.8661	270	405	2	A34522.0	
7/8	22.22	0.8748	270	405	2	A3457/8	
	22.50	0.8858	270	405	3	A34522.5	
	23.00	0.9055	270	405	3	A34523.0	
	23.50	0.9252	270	425	3	A34523.5	
	24.00	0.9449	290	440	3	A34524.0	
	24.50	0.9646	290	440	3	A34524.5	
	25.00	0.9843	290	440	3	A34525.0	
	25.40	1.0000	290	440	3	A3451 ³⁾	
1"	25.50	1.0039	290	440	3	A34525.5 ³⁾	
	26.00	1.0236	290	440	3	A34526.0 ³⁾	
	26.50	1.0433	290	440	3	A34526.5 ³⁾	
	27.00	1.0630	305	460	3	A34527.0 ³⁾	
	28.00	1.1024	305	460	3	A34528.0 ³⁾	
	29.00	1.1417	305	460	3	A34529.0 ³⁾	
	30.00	1.1811	305	460	3	A34530.0 ³⁾	
	1.1/4	31.75	1.2500	320	480	3	A3451.1/4 ³⁾
		31.00	1.2205	320	480	3	A34531.0 ³⁾
		32.00	1.2598	320	505	4	A34532.0 ³⁾
33.00		1.2992	320	505	4	A34533.0 ³⁾	
34.00		1.3386	340	530	4	A34534.0 ³⁾	
35.00		1.3780	340	530	4	A34535.0 ³⁾	
36.00		1.4173	340	530	4	A34536.0 ³⁾	
37.00		1.4567	340	530	4	A34537.0 ³⁾	
38.00		1.4961	360	555	4	A34538.0 ³⁾	
1.1/2		38.10	1.5000	360	555	4	A3451.1/2 ³⁾
	39.00	1.5354	360	555	4	A34539.0 ³⁾	
	40.00	1.5748	360	555	4	A34540.0 ³⁾	

- A951**
- Vrták s kužel. stopkou, extra dlouhý
 - Спиральное сверло с конусом Морзе, сверхдлинное исполнение
- A952**
- Wiertło bardzo długie z chwytem Morse'a
 - Vrták s kuželovou stopkou, extra dlhý

A951; A952	▪	1.1	1.2	1.3															
	•	1.4	1.5	1.6	2.1	2.2	2.3	3.1	3.2	3.3	3.4	4.1	4.2	4.3	5.1	5.2	5.3	6.1	6.2
		6.3	6.4	7.1	7.2	7.3	7.4	8.1	8.2	8.3	9.1								

A951	HSS	DIN 1870/1	15XD	130°	ST		W			
A952	HSS	DIN 1870/2	20XD	130°	ST		W			

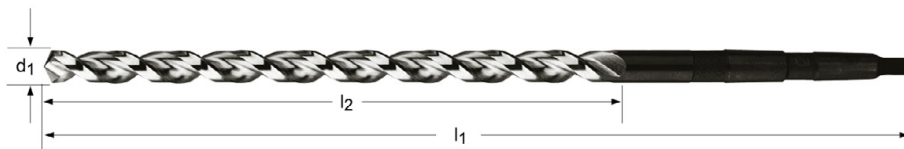

d_1 $\varnothing h_8$ mm	d_1 decimal Inch	l_2 mm	l_1 mm	MK	A951	A952
8.00	0.3150	210	330	1		A9528.0
8.50	0.3346	210	330	1		A9528.5
9.00	0.3543	220	345	1		A9529.0
10.00	0.3937	185	285	1	A95110.0	
10.00	0.3937	235	360	1		A95210.0
10.50	0.4134	235	360	1		A95210.5
11.00	0.4331	195	300	1	A95111.0	
11.00	0.4331	250	375	1		A95211.0
11.50	0.4528	250	375	1		A95211.5
12.00	0.4724	205	310	1	A95112.0	
12.00	0.4724	260	395	1		A95212.0
12.50	0.4921	205	310	1	A95112.5	
12.50	0.4921	260	395	1		A95212.5
13.00	0.5118	205	310	1	A95113.0	
13.00	0.5118	260	395	1		A95213.0
13.50	0.5315	220	325	1	A95113.5	
13.50	0.5315	275	410	1		A95213.5
14.00	0.5512	220	325	1	A95114.0	
14.00	0.5512	275	410	1		A95214.0
14.50	0.5709	220	340	2	A95114.5 ⁵⁾	
14.50	0.5709	275	425	2		A95214.5 ⁶⁾
15.00	0.5906	220	340	2	A95115.0 ⁵⁾	
15.00	0.5906	275	425	2		A95215.0 ⁶⁾
15.50	0.6102	230	355	2	A95115.5 ⁵⁾	
15.50	0.6102	295	445	2		A95215.5 ⁶⁾
16.00	0.6299	230	355	2	A95116.0 ⁵⁾	
16.00	0.6299	295	445	2		A95216.0 ⁶⁾
16.50	0.6496	230	355	2	A95116.5 ⁵⁾	

⁵⁾ < 15xD

⁶⁾ < 20xD

d_1 $\varnothing h_8$ mm	d_1 decimal Inch	l_2 mm	l_1 mm	MK	A951	A952
16.50	0.6496	295	445	2		A95216.5 ⁶⁾
17.00	0.6693	230	355	2	A95117.0 ⁵⁾	A95217.0 ⁶⁾
17.00	0.6693	295	445	2		A95217.0 ⁶⁾
17.50	0.6890	245	370	2	A95117.5 ⁵⁾	
17.50	0.6890	310	465	2		A95217.5 ⁶⁾
18.00	0.7087	245	370	2	A95118.0 ⁵⁾	
18.00	0.7087	310	465	2		A95218.0 ⁶⁾
18.50	0.7283	245	370	2	A95118.5 ⁵⁾	
18.50	0.7283	310	465	2		A95218.5 ⁶⁾
19.00	0.7480	245	370	2	A95119.0 ⁵⁾	
19.00	0.7480	310	465	2		A95219.0 ⁶⁾
19.50	0.7677	260	385	2	A95119.5 ⁵⁾	
19.50	0.7677	325	490	2		A95219.5 ⁶⁾
20.00	0.7874	260	385	2	A95120.0 ⁵⁾	
20.00	0.7874	325	490	2		A95220.0 ⁶⁾
21.00	0.8268	260	385	2	A95121.0 ⁵⁾	
21.00	0.8268	325	490	2		A95221.0 ⁶⁾
22.00	0.8661	270	405	2	A95122.0 ⁵⁾	
22.00	0.8661	345	515	2		A95222.0 ⁶⁾
23.00	0.9055	270	405	2	A95123.0 ⁵⁾	
23.00	0.9055	345	515	2		A95223.0 ⁶⁾
24.00	0.9449	290	440	3	A95124.0 ⁵⁾	
24.00	0.9449	365	555	3		A95224.0 ⁶⁾
25.00	0.9843	290	440	3	A95125.0 ⁵⁾	
25.00	0.9843	365	555	3		A95225.0 ⁶⁾
26.00	1.0236	290	440	3	A95126.0 ⁵⁾	
26.00	1.0236	365	555	3		A95226.0 ⁶⁾
27.00	1.0630	305	460	3	A95127.0 ⁵⁾	
27.00	1.0630	385	580	3		A95227.0 ⁶⁾
28.00	1.1024	305	460	3	A95128.0 ⁵⁾	
28.00	1.1024	385	580	3		A95228.0 ⁶⁾
29.00	1.1417	305	460	3	A95129.0 ⁵⁾	
29.00	1.1417	385	580	3		A95229.0 ⁶⁾
30.00	1.1811	305	460	3	A95130.0 ⁵⁾	
30.00	1.1811	385	580	3		A95230.0 ⁶⁾
31.00	1.2205	410	610	3		A95231.0 ⁶⁾
32.00	1.2598	410	635	4		A95232.0 ⁶⁾
33.00	1.2992	410	635	4		A95233.0 ⁶⁾
34.00	1.3386	430	665	4		A95234.0 ⁶⁾
35.00	1.3780	430	665	4		A95235.0 ⁶⁾
38.00	1.4961	460	695	4		A95238.0 ⁶⁾
40.00	1.5748	460	695	4		A95240.0 ⁶⁾

⁵⁾ < 15xD

⁶⁾ < 20xD

- A400**
- Stupňovitý vrták - 90°
 - Ступенчатое сверло для обработки отверстий под резьбу - 90°
 - Wiertło dwustopniowe - 90°
 - Stupňovitý vrták- 90°

A400	▪	1.1	1.2	1.3	1.4	3.1	3.2														
	•	1.5	1.6	2.1	2.2	2.3	3.3	3.4	4.1	4.2	4.3	5.1	5.2	5.3	6.1	6.2	6.3	6.4	7.1	7.2	7.3
		7.4	8.1																		

A400

HSS

DIN
8374

4XD

118°

ST

N



M	d_1 Ø mm	d_1 decimal Inch	l_2 mm	l_1 mm	l_3 mm	d_2 Ø mm	A400
M3	3.20	0.1260	57	93	9	6	A400M3
M4	4.30	0.1693	75	117	11	8	A400M4
M5	5.30	0.2087	87	133	13	10	A400M5
M6	6.40	0.2520	94	142	15	11.5	A400M6
M8	8.40	0.3307	114	169	19	15	A400M8
M10	10.50	0.4134	135	198	23	19	A400M10

- # A402
- Stupňovitý vrták - 180°
 - Ступенчатое сверло для обработки отверстий под резьбу - 180°
 - Wiertło dwustopniowe - 180°
 - Stupňovitý vrták- 180°

A402	▪	1.1	1.2	1.3	1.4	3.1	3.2														
	•	1.5	1.6	2.1	2.2	2.3	3.3	3.4	4.1	4.2	4.3	5.1	5.2	5.3	6.1	6.2	6.3	6.4	7.1	7.2	7.3
		7.4	8.1																		

A402 HSS DIN 8376 4XD 118° ST N 180°



M	d_1 Ø mm	d_1 decimal Inch	l_2 mm	l_1 mm	l_3 mm	d_2 Ø mm	A402
M3	3.40	0.1339	57	93	9	6	A402M3
M4	4.50	0.1772	75	117	11	8	A402M4
M5	5.50	0.2165	87	133	13	10	A402M5
M6	6.60	0.2598	94	142	15	11	A402M6
M8	9.00	0.3543	114	169	19	15	A402M8
M10	11.00	0.4331	130	191	23	18	A402M10

- A405**
- Stupňovitý vrták - 180°
 - Ступенчатое сверло для обработки отверстий под резьбу - 180°
 - Wiertło dwustopniowe z chwytym Morse'a - 180°
 - Stupňovitý vrták- 180°

A405	▪	1.1	1.2	1.3	1.4	3.1	3.2														
	•	1.5	1.6	2.1	2.2	2.3	3.3	3.4	4.1	4.2	4.3	5.1	5.2	5.3	6.1	6.2	6.3	6.4	7.1	7.2	7.3
		7.4	8.1																		

A405 HSS DIN 8377 4XD 118° ST N 180°

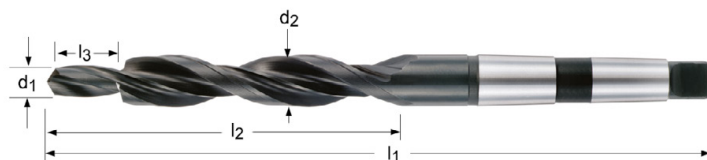

M	d ₁ ∅ mm	d ₁ decimal Inch	l ₂ mm	l ₁ mm	l ₃ mm	d ₂ ∅ mm	MK	A405
M6	6.60	0.2598	94	175	15	11	1	A405M6
M8	9.00	0.3543	114	212	19	15	2	A405M8
M10	11.00	0.4331	130	228	23	18	2	A405M10
M12	13.50	0.5315	140	238	27	20	2	A405M12
M14	15.50	0.6102	160	281	31	24	3	A405M14
M16	17.50	0.6890	165	286	35	26	3	A405M16
M18	20.00	0.7874	175	296	39	30	3	A405M18

A412

- Stupňovitý vrták
- Ступенчатое сверло
- Wiertło stopniowe
- Stupňovitý vrták

A412	▪	1.1	1.2	1.3	1.4	2.1	3.1	3.2														
	•	1.5	1.6	2.2	2.3	3.3	3.4	4.1	4.2	4.3	5.1	5.2	5.3	6.1	6.2	6.3	6.4	7.1	7.2	7.3	7.4	
		8.1																				

A412

HSS

2.5XD

118°

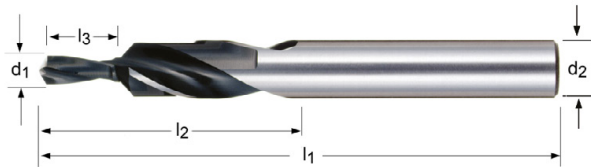

M	d_1 Ø mm	d_1 decimal Inch	l_2 mm	l_1 mm	l_3 mm	d_2 Ø mm	A412
M3	3.40	0.1339	31	70	9	6.6	A412M3
M4	4.50	0.1772	40	84	11	9	A412M4
M5	5.50	0.2165	47	95	13	11	A412M5
M6	6.60	0.2598	51	102	15	13	A412M6
M8	9.00	0.3543	62	123	19	17.2	A412M8
M10	11.00	0.4331	70	141	23	21.5	A412M10

A413

- Stupňovitý vrták
- Ступенчатое сверло
- Wiertło stopniowe
- Stupňovitý vrták

A413	▪	1.1	1.2	1.3	1.4	2.1	3.1	3.2													
	•	1.5	1.6	2.2	2.3	3.3	3.4	4.1	4.2	4.3	5.1	5.2	5.3	6.1	6.2	6.3	6.4	7.1	7.2	7.3	7.4
		8.1																			

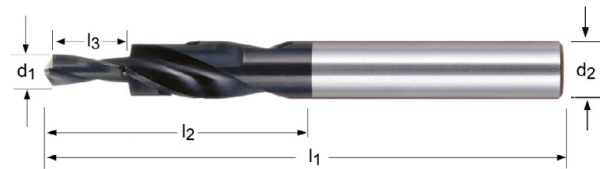

M	d ₁ Ø mm	d ₁ decimal Inch	l ₂ mm	l ₁ mm	l ₃ mm	d ₂ Ø mm	A413
M3	3.40	0.1339	28	66	9	6	A413M3
M4	4.50	0.1772	37	79	11	8	A413M4
M5	5.50	0.2165	43	89	13	10	A413M5
M6	6.60	0.2598	47	95	15	11	A413M6
M8	9.00	0.3543	56	111	19	15	A413M8
M10	11.00	0.4331	62	123	23	18	A413M10

- A200** • Středicí navrtávák - 60°
A205 • Центровочное сверло - 60°
A206 • Wiertło do nakiełków - 60°
A266 • Strediací navrtávák - 60°

A200; A205; A206; A266	▪	1.1	1.2	1.3	1.4	3.1	3.2									
	•	1.5	1.6	2.1	2.2	2.3	3.3	3.4	4.1	4.2	4.3	5.1	5.2	5.3	6.1	6.2
		6.3	6.4	7.1	7.2	7.3	7.4	8.1	8.2	8.3	9.1					

A200	HSS	DIN 333A	1XD	118°									
A205	HSS	DIN 333A	1XD	118°									
A206	HSS-E	DIN 333A	1XD	118°									
A266	HSS-E	DIN 333A	1XD	118°									



A200	A205	A206	A266
0.50 - 12.50	1.00 - 5.00	1.00 - 5.00	1.00 - 5.00

d ₁ Ø mm	d ₁ decimal Inch	l ₂ max/min mm	l ₁ mm	d ₂ Ø mm	A200	A205	A206	A266
0.50	0.0197	0.9 - 0.6	25	3.15	A200.5X3.15 ⁷⁾			
0.80	0.0315	1.3 - 1.0	25	3.15	A200.8X3.15 ⁷⁾			
1.00	0.0394	1.7 - 1.3	31	3.15	A2001.0X3.15	A2051.0X3.15	A2061.0X3.15	A2661.0X3.15
1.25	0.0492	2.0 - 1.6	31	3.15	A2001.25X3.15	A2051.25X3.15	A2061.25X3.15	A2661.25X3.15
1.60	0.0630	2.6 - 2.0	35	4.00	A2001.6X4.0	A2051.6X4.0	A2061.6X4.0	A2661.6X4.0
2.00	0.0787	3.1 - 2.5	40	5.00	A2002.0X5.0	A2052.0X5.0	A2062.0X5.0	A2662.0X5.0
2.50	0.0984	3.8 - 3.1	45	6.30	A2002.5X6.3	A2052.5X6.3	A2062.5X6.3	A2662.5X6.3
3.15	0.1240	4.6 - 3.9	50	8.00	A2003.15X8.0	A2053.15X8.0	A2063.15X8.0	A2663.15X8.0
4.00	0.1575	5.9 - 5.0	55	10.00	A2004.0X10.0	A2054.0X10.0	A2064.0X10.0	A2664.0X10.0
5.00	0.1969	7.2 - 6.3	63	12.50	A2005.0X12.5	A2055.0X12.5	A2065.0X12.5	A2665.0X12.5
6.30	0.2480	8.9 - 8.0	71	16.00	A2006.3X16.0			
8.00	0.3150	11.1 - 10.1	80	20.00	A2008.0X20.0			
10.00	0.3937	13.8 - 12.8	100	25.00	A2010.0X25.0			
12.50	0.4921	17.5 - 16.5	125	31.50	A2012.5X31.5			

⁷⁾ Pouze jednostranný / Только одностороннее / Pojedyńcze / Iba jednostranný

A210

- Středící navrtávák Radiusový
- Центровочное сверло Радиусная форма
- Wiertło do nakiełków Kształt promieniowy
- Strediaci navrtavák Rádiusový

A210	▪	1.1	1.2	1.3	1.4	3.1	3.2														
	•	1.5	1.6	2.1	2.2	2.3	3.3	3.4	4.1	4.2	4.3	5.1	5.2	5.3	6.1	6.2	6.3	6.4	7.1	7.2	7.3
		7.4	8.1	8.2	8.3	9.1															

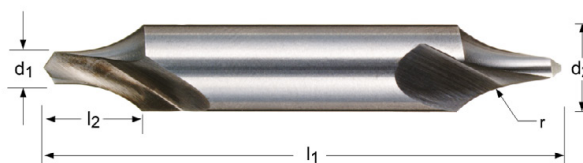

d_1 Ø mm	d_1 decimal Inch	l_2 max/min mm	l_1 mm	r max/min mm	d_2 Ø mm	A210
0.50	0.0197	2.6 - 2.3	25.0	2.50 - 2.00	3.15	A210.5X3.15 ⁷⁾
0.80	0.0315	2.9 - 2.6	25.0	3.15 - 2.50	3.15	A210.8X3.15 ⁷⁾
1.00	0.0394	3.3 - 3.0	31.0	3.65 - 2.90	3.15	A2101.0X3.15
1.25	0.0492	3.6 - 3.3	31.0	3.95 - 3.15	3.15	A2101.25X3.15
1.60	0.0630	4.7 - 4.2	35.0	5.00 - 4.00	4.00	A2101.6X4.0
2.00	0.0787	5.4 - 5.0	40.0	6.25 - 5.00	5.00	A2102.0X5.0
2.50	0.0984	6.8 - 6.3	45.0	7.88 - 6.30	6.30	A2102.5X6.3
3.15	0.1240	8.5 - 8.0	50.0	10.00 - 8.00	8.00	A2103.15X8.0
4.00	0.1575	10.6 - 10.0	55.0	12.50 - 10.00	10.00	A2104.0X10.0
5.00	0.1969	13.1 - 12.5	63.0	15.63 - 12.50	12.50	A2105.0X12.5
6.30	0.2480	16.6 - 16.0	71.0	20.00 - 16.00	16.00	A2106.3X16.0
8.00	0.3150	20.7 - 20.0	80.0	25.00 - 20.00	20.00	A2108.0X20.0
10.00	0.3937	25.7 - 25.0	100.0	31.25 - 25.00	25.00	A21010.0X25.0

A201

- Středicí navrtávák - 60°
- Центровочное сверло - 60°
- Wiertło do nakiełków - 60°
- Strediací navrtávák - 60°

A201	▪	1.1	1.2	1.3	1.4	3.1	3.2														
	•	1.5	1.6	2.1	2.2	2.3	3.3	3.4	4.1	4.2	4.3	5.1	5.2	5.3	6.1	6.2	6.3	6.4	7.1	7.2	7.3
		7.4	8.1	8.2	8.3	9.1															

A201 HSS DORMER 1XD 122° 60°

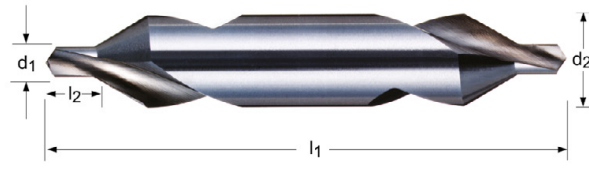

d ₁ Ø mm	d ₁ decimal Inch	l ₂ max/min mm	l ₁ mm	d ₂ Ø mm	A201
0.63	0.0248	1.2 - 0.9	20	3.15	A201.63X3.15 ⁷⁾
0.75	0.0295	1.3 - 1.0	35	3.50	A201.75X3.5
1.00	0.0394	2.1 - 1.5	35	4.00	A2011.0X4.0
1.50	0.0591	2.8 - 2.0	40	5.00	A2011.5X5.0
1.60	0.0630	2.4 - 2.0	40	5.00	A2011.6X5.0
2.00	0.0787	4.0 - 3.0	45	6.00	A2012.0X6.0
2.00	0.0787	2.9 - 2.5	45	6.30	A2012.0X6.3
2.50	0.0984	4.5 - 3.5	50	8.00	A2012.5X8.0
3.00	0.1181	4.4 - 3.9	50	8.00	A2013.0X8.0
3.00	0.1181	5.0 - 4.0	56	10.00	A2013.0X10.0
3.15	0.1240	4.4 - 3.9	56	10.00	A2013.15X10.0
4.00	0.1575	6.2 - 5.0	66	12.00	A2014.0X12.0
5.00	0.1969	7.7 - 6.5	78	14.00	A2015.0X14.0
6.00	0.2362	9.2 - 8.0	90	18.00	A2016.0X18.0

⁷⁾ Pouze jednostranný / Только одностороннее / Pojedyncze / Iba jednostranný

A225

- Středící navrtávák - 60°
- Центровочное сверло - 60°
- Wiertło do nakiełków - 60°
- Strediací navrtávák - 60°

A225	▪	1.1	1.2	1.3	1.4	3.1	3.2														
	•	1.5	1.6	2.1	2.2	2.3	3.3	3.4	4.1	4.2	4.3	5.1	5.2	5.3	6.1	6.2	6.3	6.4	7.1	7.2	7.3
		7.4	8.1	8.2	8.3	9.1															

A225 HSS BS 328 1XD 120° 60° A296 136

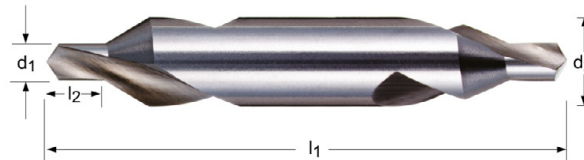

Nr.	d ₁ Ø Inch	d ₁ decimal Inch	l ₂ max/min Inch	l ₁ Inch	d ₂ Ø Inch	A225
BS1	3/64	0.0469	5/64 - 1/16	1.1/2	1/8	A225BS1
BS2	1/16	0.0625	3/32 - 5/64	1.3/4	3/16	A225BS2
BS3	3/32	0.0938	5/32 - 1/8	2"	1/4	A225BS3
BS4	1/8	0.1250	3/16 - 5/32	2.1/4	5/16	A225BS4
BS5	3/16	0.1875	9/32 - 1/4	2.1/2	7/16	A225BS5
BS5A	7/32	0.2188	5/16 - 9/32	2.3/4	1/2	A225BS5A
BS6	1/4	0.2500	3/8 - 5/16	3"	5/8	A225BS6
BS7	5/16	0.3125	15/32 - 13/32	3.1/2	3/4	A225BS7

- A237**
- Středící navrtávák - 60° Stopka s ploškou
 - Центровочное сверло - 60° Хвостовик с лыской
 - Wiertło do nakiełków - 60° Płaski chwyt
 - Strediací navrtávák - 60° Stopka s ploškou

A237	▪	1.1	1.2	1.3	1.4	3.1	3.2														
	•	1.5	1.6	2.1	2.2	2.3	3.3	3.4	4.1	4.2	4.3	5.1	5.2	5.3	6.1	6.2	6.3	6.4	7.1	7.2	7.3
		7.4	8.1	8.2	8.3	9.1															

A237 HSS-E **DIN 333A** 1XD

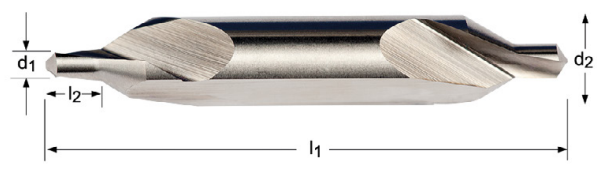

d ₁ Ø mm	d ₁ decimal Inch	l ₂ max/min mm	l ₁ mm	d ₂ Ø mm	d ₄ max/min mm	A237
1.60	0.0630	2.6 - 2.0	35	4.00	3.25 - 3.15	A2371.6X4.0
2.00	0.0787	3.1 - 2.5	40	5.00	4.20 - 4.10	A2372.0X5.0
2.50	0.0984	3.8 - 3.1	45	6.30	5.35 - 5.25	A2372.5X6.3
3.15	0.1240	4.6 - 3.9	50	8.00	6.95 - 6.85	A2373.15X8.0
4.00	0.1575	5.9 - 5.0	55	10.00	8.40 - 8.30	A2374.0X10.0
5.00	0.1969	7.2 - 6.3	63	12.50	10.95 - 10.85	A2375.0X12.5
6.30	0.2480	8.9 - 8.0	71	16.00	14.00 - 13.90	A2376.3X16.0
8.00	0.3150	11.1 - 10.1	80	20.00	17.90 - 17.80	A2378.0X20.0
10.00	0.3937	13.8 - 12.8	100	25.00	22.50 - 22.40	A23710.0X25.0

- A238**
- Středící navrtávák Radiusový navrtávák, stopka s ploškou
 - Центровочное сверло Радиусный профиль и хвостовик с лыской
 - Wiertło do nakiełków Zaokrąglony i płaski chwyt
 - Strediaci navrtavák Kruhový tvar a stopka s plôškou

A238	▪	1.1	1.2	1.3	1.4	3.1	3.2														
	•	1.5	1.6	2.1	2.2	2.3	3.3	3.4	4.1	4.2	4.3	5.1	5.2	5.3	6.1	6.2	6.3	6.4	7.1	7.2	7.3
		7.4	8.1	8.2	8.3	9.1															

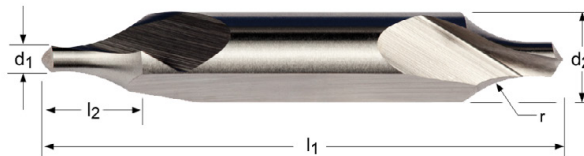

d_1 Ø mm	d_1 decimal Inch	l_2 max/min mm	l_1 mm	r max/min mm	d_2 Ø mm	d_4 max/min mm	A238
1.60	0.0630	4.7 - 4.2	35	5.00 - 4.00	4.00	3.25 - 3.15	A2381.6X4.0
2.00	0.0787	5.4 - 5.0	40	6.25 - 5.00	5.00	4.20 - 4.10	A2382.0X5.0
2.50	0.0984	6.8 - 6.3	45	7.88 - 6.30	6.30	5.35 - 5.25	A2382.5X6.3
3.15	0.1240	8.5 - 8.0	50	10.00 - 8.00	8.00	6.95 - 6.85	A2383.15X8.0
4.00	0.1575	10.6 - 10.0	55	12.50 - 10.00	10.00	8.40 - 8.30	A2384.0X10.0
5.00	0.1969	13.1 - 12.5	63	15.63 - 12.50	12.50	10.95 - 10.85	A2385.0X12.5
6.30	0.2480	16.6 - 16.0	71	20.00 - 16.00	16.00	14.00 - 13.90	A2386.3X16.0
8.00	0.3150	20.7 - 20.0	80	25.00 - 20.00	20.00	17.90 - 17.80	A2388.0X20.0

A242

- Středicí navrtávák - 60°
- Центровочное сверло - 60°
- Wiertło do nakiełków - 60°
- Strediací navrtávák - 60°

A242	▪	1.1	1.2	1.3	1.4	3.1	3.2														
	•	1.5	1.6	2.1	2.2	2.3	3.3	3.4	4.1	4.2	4.3	5.1	5.2	5.3	6.1	6.2	6.3	6.4	7.1	7.2	7.3
		7.4	8.1	8.2	8.3	9.1															

A242 HSS-E 1XD



d_1 \emptyset mm	d_1 decimal Inch	l_2 max/min mm	l_1 mm	d_2 \emptyset mm	A242
1.00	0.0394	1.7 - 1.3	100	4.00	A2421.0X4.0
1.50	0.0591	2.6 - 2.0	100	5.00	A2421.5X5.0
2.00	0.0787	3.1 - 2.5	100	6.00	A2422.0X6.0
2.50	0.0984	3.8 - 3.1	100	8.00	A2422.5X8.0
3.00	0.1181	4.6 - 3.9	100	8.00	A2423.0X8.0
3.00	0.1181	4.6 - 3.9	100	10.00	A2423.0X10.0
4.00	0.1575	5.9 - 5.0	100	10.00	A2424.0X10.0
4.00	0.1575	5.9 - 5.0	100	12.00	A2424.0X12.0
5.00	0.1969	7.2 - 6.3	100	12.00	A2425.0X12.0

A088

- Navrtávák, sada
- Набор спиральных сверл, короткое исполнение
- Zestaw wiertel ogólnego stosowania
- Navrtávák, sada

A=typy v sadě, B=počet v sadě, C=rozměry v sadě

A=тип сверл в наборе, B=кол-во сверл, C=диаметры сверл

A=Typy w komplecie. B=Ilość w komplecie. C=Średnice występujące w komplecie

A=typy v sade, B=počet v sade, C=rozmery v sade



Set	A	B	C	A088
200S	A022	24	1.0 mm - 10.5 mm x 0.5 mm + 3.3 mm, 4.2 mm, 6.8 mm, 10.2 mm	A088200S

A095

- Vrták zákl. délka, sada
- Набор спиральных сверл, короткое исполнение
- Zestaw wiertel ogólnego stosowania
- Vrták zákl. délka, sada

A=typy v sadě, B=počet v sadě, C=rozměry v sadě

A=тип сверл в наборе, B=кол-во сверл, C=диаметры сверл

A=Typy w komplecie. B=Ilość w komplecie. C=Średnice występujące w komplecie

A=typy v sade, B=počet v sade, C=rozmery v sade



Set	A	B	C	A095
18	A002	29	1/16 inch - 1/2 inch x 1/64 inch	A09518
20	A002	15	1/16 inch - 1/2 inch x 1/32 inch	A09520
200	A002	24	1.0 mm - 10.5 mm x 0.5 mm + 3.3 mm, 4.2 mm, 6.8 mm, 10.2 mm	A095200
201	A002	19	1.0 mm - 10.0 mm x 0.5 mm	A095201
202	A002	51	1.0 mm - 6.0 mm x 0.1 mm	A095202
203	A002	41	6.0 mm - 10.0 mm x 0.1 mm	A095203
204	A002	25	1.0 mm - 13.0 mm x 0.5 mm	A095204
206	A002	29	1.0 mm - 13.0 mm x 0.5 mm + 3.3 mm, 4.2 mm, 6.8 mm, 10.2 mm	A095206
209	A002	91	1.0 mm - 10.0 mm x 0.1 mm	A095209

A087

- Kompaktní sada vrtáků A=typy v sadě, B=počet v sadě, C=rozměry v sadě
- Набор свёрел A=тип сверл в наборе, B=кол-во сверл, C=диаметры сверл
- Zestaw wiertel A=Typy w komplecie. B=Ilość w komplecie. C=Średnice występujące w komplecie
- Kompaktná sada vrtákov A=typy v sade, B=počet v sade, C=rozmery v sade



Set

Nr.	A	B	C	A087
201	A002	19	1.0 mm - 10.0 mm x 0.5 mm	A087201

A094

- Vrták zákl. délka, sada
- Набор спиральных сверл, короткое исполнение
- Zestaw wiertel ogólnego stosowania
- Vrták základná dĺžka, sada

A=typy v sadě, B=počet v sadě, C=rozměry v sadě

A=тип сверл в наборе, B=кол-во сверл, C=диаметры сверл

A=Typy w komplecie. B=Ilość w komplecie. C=Średnice występujące w komplecie

A=typy v sade, B=počet v sade, C=rozmery v sade



Set	A	B	C	A094
413	A002	13	1.5 mm - 6.5 mm x 0.5 mm + 3.3 mm, 4.2 mm	A094413
419	A002	19	1.0 mm - 10.0 mm x 0.5 mm	A094419

A089

- Vrták zákl. délka, sada
- Набор спиральных сверл, короткое исполнение
- Zestaw wiertel ogólnego stosowania
- Vrták základná dĺžka, sada

A=typy v sadě, B=počet v sadě, C=rozměry v sadě

A=тип сверл в наборе, B=кол-во сверл, C=диаметры сверл

A=Typy w komplecie. B=Ilość w komplecie. C=Średnice występujące w komplecie

A=typy v sade, B=počet v sade, C=rozmary v sade



A089



Set

A089

Nr.	A	B	C	
10	A002	5	A0024.0, A0025.0, A0026.0, A0028.0, A00210.0	A08910

A099

- Příhradkový pořadač
- Набор спиральных сверл в металлическом стеллаже
- Zestaw wiertel ogólnego stosowania
- Box na sadu vrtákov

A=typy v sadě, B=počet v sadě, C=rozměry v sadě

A=тип сверл в наборе, B=кол-во сверл, C=диаметры сверл

A=Typy w komplecie. B=Ilość w komplecie. C=Średnice występujące w komplecie

A=typy v sade, B=počet v sade, C=rozmery v sade

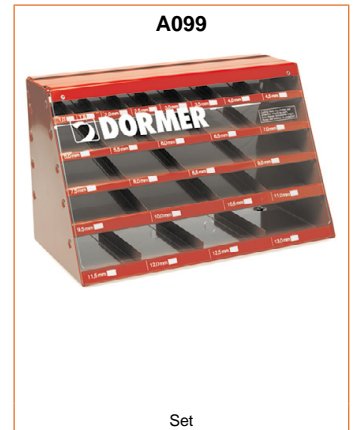

Set	A	B	C
F1	A002	380	5 x (13/32, 7/16, 15/32, 1/2) inch; 10 x (5/64, 7/64, 9/64, 11/64, 13/64, 15/64, 17/64, 9/32, 19/64, 5/16, 21/64, 11/32, 23/64, 3/8) inch; 20 x (1/16, 7/32, 1/4) inch; 30 x 3/32 inch; 40 x (5/32, 3/16) inch; 50 x 1/8 inch
M1	A002	340	5 x (10.50, 11.00, 11.50, 12.00, 12.50, 13.00) mm; 10 x (1.50, 2.50, 3.50, 4.50, 5.50, 6.50, 7.00, 7.50, 8.00, 8.50, 9.00, 9.50, 10.00) mm; 20 x (1.00, 5.00, 6.00) mm; 30 x 2.00 mm; 40 x 4.00 mm; 50 x 3.00 mm

Set	A	B	C
A099			
A099F1			
A099M1			



Set	A	B	C
DRILLBOY	A002	43	3 x (3.0 mm, 3.3 mm, 3.5 mm, 4.0 mm) 2 x (4.2 mm, 4.5 mm, 5.0 mm, 5.5 mm, 6.0 mm, 6.5 mm, 6.8 mm, 7.0 mm, 7.5 mm, 8.0 mm) + 8.5 mm, 9.0 mm, 9.5 mm, 10.0 mm, 10.2 mm, 10.5 mm, 11.0 mm, 11.5 mm, 12.0 mm, 12.5 mm, 13.0 mm

Set	A	B	C
A099			
A099DRILLBOY			

A199

- Příhradkový pořadač
- Набор спиральных сверл в металлическом стеллаже
- Zestaw wiertel ogólnego stosowania
- Box na sadu vrtákov

A=typy v sadě, B=počet v sadě, C=rozměry v sadě

A=тип сверл в наборе, B=кол-во сверл, C=диаметры сверл

A=Typy w komplecie. B=Ilość w komplecie. C=Średnice występujące w komplecie

A=typy v sade, B=počet v sade, C=rozmery v sade



A199



Set

Set	A	B	C	A199
F1	A100	380	5 x (13/32, 7/16, 15/32, 1/2) inch; 10 x (5/64, 7/64, 9/64, 11/64, 13/64, 15/64, 17/64, 9/32, 19/64, 5/16, 21/64, 11/32, 23/64, 3/8) inch; 20 x (1/16, 7/32, 1/4) inch; 30 x 3/32 inch; 40 x (5/32, 3/16) inch; 50 x 1/8 inch	A199F1
M1	A100	340	5 x (10.50, 11.00, 11.50, 12.00, 12.50, 13.00) mm; 10 x (1.50, 2.50, 3.50, 4.50, 5.50, 6.50, 7.00, 7.50, 8.00, 8.50, 9.00, 9.50, 10.00) mm; 20 x (1.00, 5.00, 6.00) mm; 30 x 2.00 mm; 40 x 4.00 mm; 50 x 3.00 mm	A199M1

A080

- Příhradkový pořadač
- Набор спиральных сверл в металлическом стеллаже
- Zestaw wiertel ogólnego stosowania
- Box na sadu vrtákov

Prázdny zásobník
 Пустой раздатчик
 Pusty pojemnik
 Prázdny zásobník



A080	
	
Set	
A080	
M1EMPTY	A080M1EMPTY
F1EMPTY	A080F1EMPTY

Nr.	d ∅ mm
M1EMPTY	(1.00, 1.50, 2.00, 2.50, 3.00, 3.50, 4.00, 4.50, 5.00, 5.50, 6.00, 6.50, 7.00, 7.50, 8.00, 8.50, 9.00, 9.50, 10.00, 10.50, 11.00, 11.50, 12.00) mm
F1EMPTY	(1/16, 5/64, 3/32, 7/64, 1/8, 9/64, 5/32, 11/64, 3/16, 13/64, 7/32, 15/64, 1/4, 17/64, 9/32, 19/64, 5/16, 21/64, 11/32, 3/8, 13/32, 7/16, 1/2) inch

A190

- Vrták zákl. délka, sada
- Набор спиральных сверл, короткое исполнение
- Zestaw wiertel ogólnego stosowania
- Vrták základná dĺžka, sada

A=typy v sadě, B=počet v sadě, C=rozměry v sadě

A=тип сверл в наборе, B=кол-во сверл, C=диаметры сверл

A=Typy w komplecie. B=Ilość w komplecie. C=Średnice występujące w komplecie

A=typy v sade, B=počet v sade, C=rozmary v sade



Set	A	B	C	A190
3	A100	21	1/16 inch - 3/8 inch x 1/64 inch	A1903
12	A100	60	No.1 - No.60	A19012
18	A100	29	1/16 inch - 1/2 inch x 1/64 inch	A19018
20	A100	15	1/16 inch - 1/2 inch x 1/32 inch	A19020
201	A100	19	1.0 mm - 10.0 mm x 0.5 mm	A190201
202	A100	51	1.0 mm - 6.0 mm x 0.1 mm	A190202
203	A100	41	6.0 mm - 10.0 mm x 0.1 mm	A190203
204	A100	25	1.0 mm - 13.0 mm x 0.5 mm	A190204
206	A100	29	1.0 mm - 13.0 mm x 0.5 mm + 3.3 mm, 4.2 mm, 6.8 mm, 10.2 mm	A190206
209	A100	91	1.0 mm - 10.0 mm x 0.1 mm	A190209 ⁸⁾

⁸⁾ A190209 se dodává ve dvou krabicích: krabice 1 (1,0–5,9 × 0,1 mm) + krabice 2 (6,0–10,0 × 0,1 mm) / A190209 продается в 2 коробках: коробка 1 (1,0–5,9 × 0,1 мм) + коробка 2 (6,0–10,0 × 0,1 мм) / A190209 jest sprzedawany w 2 pudełkach: pudełko 1 (1,0-5,9 × 0,1mm) + pudełko 2 (6,0-10,0 × 0,1mm) / A190209 sa predáva v 2 baleniach: balenie 1 (1,0 – 5,9 × 0,1 mm) + balenie 2 (6,0 – 10,0 × 0,1 mm)

A191

- Vrták zákl. délka, sada
- Набор спиральных сверл, короткое исполнение
- Zestaw wiertel ogólnego stosowania
- Vrták základná dĺžka, sada

Broušený povrch pod 1,0 mm, 3/64", N60. A=typy v sadě, B=počet v sadě, C=rozměry v sadě

Менее 1,0mm, 3/64", N60 полированные. A=тип сверл в наборе, B=кол-во сверл, C=диаметры сверл.

Nierokrywane poniżej 1,0mm, 3/64", N60. A=Typy w komplecie. B=Ilość w komplecie. C=Średnice występujące w komplecie

Brúsený povrch pod 1,0 mm, 3/64", N60. A=typy v sade, B=počet v sade, C=rozmery v sade



A191



Set

Set	A	B	C	A191
31M	A100	20	0.3 mm - 1.0 mm x 0.05 mm + 0.38 mm, 0.52 mm, 0.58 mm, 0.78 mm, 0.82 mm	A19131M
61-80	A100	20	No.61 - No. 80	A19161-80
413	A100	13	1.5 mm - 6.5 mm x 0.5 mm + 3.3 mm, 4.2 mm	A191413
419	A100	19	1.0 mm - 10.0 mm x 0.5 mm	A191419

A188

- Vrták zákl. délka, sada
- Набор спиральных сверл, короткое исполнение
- Zestaw wiertel ogólnego stosowania
- Vrták základná dĺžka, sada

A=typy v sadě, B=počet v sadě, C=rozměry v sadě

A=тип сверл в наборе, B=кол-во сверл, C=диаметры сверл

A=Typy w komplecie. B=Ilość w komplecie. C=Średnice występujące w komplecie

A=typy v sade, B=počet v sade, C=rozmary v sade



Nr.	A	B	C	A188
201	A108	19	1.0 mm - 10.0 mm x 0.5 mm	A188201
204	A108	25	1.0 mm - 13.0 mm x 0.5 mm	A188204

A295

- Vrták zákl. délka, sada
- Набор спиральных сверл, короткое исполнение
- Zestaw wiertel ogólnego stosowania
- Vrták základná dĺžka, sada

- 4 fazetkový vrchol až do 1.4 mm, A=typy v sadě, B=počet v sadě, C=rozměry v sadě
- 118° стандартная заточка до 1,4 мм. A=тип сверл в наборе, B=кол-во сверл, C=диаметры сверл
- 4 płaszczynowe ostrze do 1.4mm. A=Typy w komplecie. B=Ilość w komplecie. C=Średnice występujące w komplecie
- 4 fazetkový vrchol až do 1.4 mm, A=typy v sade, B=počet v sade, C=rozmary v sade



Set	A	B	C	A295
219	A777	19	1.0 mm - 10.0 mm x 0.5 mm	A295219
225	A777	25	1.0 mm - 13.0 mm x 0.5 mm	A295225

A296

- Středící navrtávák sada
- Набор центровочных сверл
- Zestaw wiertel do nakielków
- Strediací navrtávák sada

A296200 - 118° špička DIN333A, A296225 - 120° BS328. A=typy v sadě, B=počet v sadě, C=rozměry v sadě

A296200 — 118° вершина DIN333A, A296225 — 120° вершина BS328. A=тип сверл в наборе, B=кол-во сверл, C=диаметры сверл

A296200- 118°.DIN333A,A296225- 120°. BS328. A=Типу w kompletie. B=Ilość w kompletie. C=Średnice występujące w kompletie

A296200 - 118° špička DIN333A, A296225 - 120° BS328. A=typy v sade, B=počet v sade, C=rozmery v sade



Nr.	A	B	C	A296
200	A200	5	1.00 mm, 2.00 mm, 2.50 mm, 3.15 mm, 4.00 mm	A296200
225	A225	5	BS1, BS2, BS3, BS4, BS5	A296225



143 - 200



B100	158	B411	156	G106	189	G171	196
B101	176	B441	155	G107	192	G236	199
B121	178	B442	157	G125	198	G314	197
B122	166	B481	153	G129	187	G335	184
B157	173	B901	162	G132	194	G338	195
B161	174	B903	164	G135	184	G400	183
B170	170	B952	165	G136	189	G506	189
B180	168	B953	167	G137	185	G560	189
B301	163	B954	179	G138	195	G570	191
B334	160	B955	180	G142	191	G600	193
B335	161	B956	181	G149	188		
B400	152	B957	182	G154	186		

Materiál	Материал	Materiał	Materiál
Povlak	Покрытие	Pokrycie	Povlak
Standard	Стандарт	Standard	Štandard
Směr otáčení	Направление	Kierunek	Smer otáčania
Stopka	Хвостовик	Chwyt	Stopka
Typ drážek	Тип канавок	Typ rowka wiórowego	Typ drážok
Tolerance	Допуск	Tolerancja	Tolerancia
Kuželovitost	Конусность	Zbieżność (pochylenie)	Kuželovitost'
<ul style="list-style-type: none"> ■ vynikající ● dobrý <p>Příklad 10 = řezná rychlost (m/min) +/- 10%</p>	<p>Основное применение</p> <p>Возможное применение</p> <p>Пример: 10 = Скорость резания в м/мин +/- 10%</p>	<p>Najlepsze zastosowanie</p> <p>Dobre zastosowanie</p> <p>Na Przykład 10 = prędkość skrawania w m/min +/- 10%</p>	<p>Vynikajúce</p> <p>Dobré</p> <p>Príklad 10 = rezná rýchlosť (m/min) +/- 10%</p>
Kód	Код	Kod	Kód
Rozměrová řada	Ассортимент	Zakres średnic	Rozsah rozmerov

AMG	Česky	Русский	Polski	Slovensky
1.1	magneticky měkká	Автоматная сталь	magnetyczna miękka	Magnetycky mäkká oceľ
1.2	konstrukční uhlíkatá	Низкоуглеродистая сталь	konstrukcyjna do nawęglania	Konstruktórná oceľ, uhlíková
1.3	uhlíkatá	Углеродистая нелегированная сталь	węgłowa	Uhlíková oceľ
1.4	legovaná	Легированная сталь	stopowa	Legovaná oceľ
1.5	legovaná, tvrzená a temperovaná	Легированная сталь после отжига	stopowa-hartowana i odpuszczana	Legovaná oceľ, tvrdená a temperovaná
1.6	legovaná, tvrzená a temperovaná	Высоколегированная сталь после отжига	stopowa-hartowana i odpuszczana	Legovaná oceľ, tvrdená a temperovaná
1.7	legovaná, tvrzená	Легированная закаленная сталь	stopowa-hartowana	Legovaná oceľ tvrdená
1.8	legovaná, tvrzená	Легированная закаленная сталь	stopowa-hartowana	Legovaná oceľ tvrdená, oceľ odolná oproti opotrebovaniu
2.1	automatová	Ферритная нержавеющая сталь	automatowa	Automatová nehrdzavejúca oceľ
2.2	austenitická	Аустенитная нержавеющая сталь	austenityczna	Austenická
2.3	feritická+austenitická	Ферритно-аустенитная нержавеющая сталь	ferytyczna+austenityczna	Feriticko austenitická nehr. oceľ (Duplex)
2.4	precipitačně tvrzená	Сталь дисперсионного твердения	Utwardzane wydzieleniowo	Tvrdená nehr. oceľ
3.1	lamelární	Серый чугуn	szare	Sivá liatina
3.2	lamelární	Ковкий чугуn	szare	Sivá liatina
3.3	nodulární	Высокопрочный чугуn	sferoidalne ciagłwie	Tvárná liatina
3.4	nodulární	Высокопрочный чугуn	sferoidalne ciagłwie	Tvárná liatina
4.1	čistý	Технически чистый титан	niestopowy	Čistý titán
4.2	slitiny	Титановые сплавы	stopy tytanu	Zliatiny titánu
4.3	slitiny	Титановые сплавы	stopy tytanu	Zliatiny titánu
5.1	čistý	Технически чистый никель	niestopowy	Čistý nikel
5.2	slitiny	Никелевые сплавы	stopy niklu	Zliatiny niklu
5.3	slitiny	Никелевые сплавы	stopy niklu	Zliatiny niklu
6.1	bronz	Технически чистая медь	niestopowa	Bronz
6.2	β - mosaz, bronz	Бронза	Mosiądz-β, brąz	β - mosadz, bronz
6.3	bronz mosaz	Латунь	Mosiądz CuZn	Mosadz, bronz
6.4	bronz vysokopevnostní	Высокопрочная бронза	Brąz o wysokiej wytrzymałości	Vysokopevnostný bronz
7.1	Al, Mg, tvářené	Технически чистый алюминий/магний	Al.,Mg, niestopowe	Al, Mg, tvárnený (čistý)
7.2	Al slitiny, Si<0.5%	Сплавы Al с содержанием Si<0.5%	Al. Stopowe, Si<0,5%	Al zliatiny, Si<0,5%
7.3	Al slitiny, Si>0.5%<10%	Сплавы Al с содержанием 0.5%<Si<10%	Al. Stopowe, Si>0,5%<10%	Al zliatiny, Si>0,5%<10%
7.4	Al slitiny, Si>10%	Сплавы Al с содержанием Si>10%	Al. Stopowe, Si>10%	Al zliatiny, Si>10%
8.1	termoplasty	Термопластики	Tworzywa termoplastyczne	Termoplasty
8.2	termosety	Терморезактивные полимеры	Tworzywa termoutwardzalne	Termosety
8.3	zpevněné plasty	Армированные полимеры	Zbrojone tworzywa sztuczne	Spevněné plasty
9.1	cermet (keramika)	Металлокерамика	Cermetale	Cermet (kov-keramika)
10.1	standardni grafit	Технический графит	Grafit standartowy	Grafit

	HM	HM	HM	HM	HM	HSS	HSS	HSS	HSS-E	HSS	HSS	HSS	HSS	HSS-E	HSS-E	HSS-E	HSS-E	
	DIN 8093	DIN 8093	DIN 8050	DIN 8094	DIN 8051	DIN 206	DORMER	DORMER	BS 328	BS 328	DIN 9	DIN 9	ANSI	DIN 2179	DIN 212	DIN 212	DIN 212	
		DIN 6535HA 													DIN 6535HA 			
	B	B	A	B	A	B			B	A	A	B			B	B	E	
	H7	0.95-5.5 0,+0.004 05.51-12 0,+0.005	H7	H7	H7	H7			H7						H7	0.95-5.5 0,+0.004 05.51-12 0,+0.005	H7	
									1:48	1:50	1:50			1:50				
	B400	B481	B441	B411	B442	B100	B334	B335	B901	B301	B903	B952	B122	B953	B180	B170	B157	
	1.00 - 20.00	0.98 - 12.05	10.00 - 20.00	5.00 - 30.00	10.00 - 20.00	1.50 - 50.00	N000 - N16	N000BLADES - N16NUT	1.50 - 1/2	1/16 - 1/2	1.50 - 20.00	1.20 - 50.00	3/8 - 1.1/16	1.00 - 12.00	1.50 - 20.0	0.98 - 12.00	2.00 - 20.00	
AMG	152	153	155	156	157	158	160	161	162	163	164	165	166	167	168	170	173	ISO
1.1	18B	18B	18B	18B	18B	18C	18C		18C	18C	18C	18C	18C	25C	25C	25C	25C	P 1
1.2	18B	18B	18B	18B	18B	14C	14C		14C	14C	14C	14C	14C	20C	20C	20C	20C	P 1
1.3	14B	14B	14B	14B	14B	11C	11C		11C	11C	11C	11C	11C	16C	16C	16C	16C	P 2
1.4	14B	14B	14B	14B	14B	10B	10B		10B	10B	10B	10B	10B	15B	15B	15B	15B	P 3
1.5	10C	10C	10C	10C	10C	5B	5B		5B	5B	5B	5B	5B	9B	9B	9B	9B	P 4
1.6	10C	10C	10C	10C	10C	4A	4A		4A	4A	4A	4A	4A	5A	5A	5A	5A	H 1
1.7																		H 3
1.8																		H 4
2.1						8F	8F		8C	8C	8C	8C	8C	11C	11C	11C	11C	M 1
2.2									5B	5B	5B	5B	5B	6B	6B	6B	6B	M 3
2.3									6B	6B	6B	6B	6B	8B	8B	8B	8B	M 2
2.4														6B				S 2
3.1	17D	17D	17D	17D	17D	14E	14E		14E	14E	14E	14E	14E	16E	16E			K 1
3.2	17D	17D	17D	17D	17D	11D	11D		11D	11D	11D	11D	11D	15D	15D			K 2
3.3	17D	17D	17D	17D	17D	10C	10C		10C	10C	10C	10C	10C	13C	13C			K 3
3.4	14D	14D	14D	14D	14D	9C	9C		9C	9C	9C	9C	9C	11C	11C			K 4
4.1	14C	14C	14C	14C	14C	11C	11C		11C	11C	11C	11C	11C	15C	15C	15C	15C	S 1
4.2	14C	14C	14C	14C	14C	5B	5B		5B	5B	5B	5B	5B	9B	9B	9B	9B	S 2
4.3	10B	10B	10B	10B	10B	4B	4B		4B	4B	4B	4B	4B	5B	5B	5B	5B	S 3
5.1	10C	10C	10C	10C	10C	5D	5D		5D	5D	5D	5D	5D	8D	8D	8D	8D	S 1
5.2	10B	10B	10B	10B	10B	3C	3C		3C					5C	5C	5C	5C	S 2
5.3	10B	10B	10B	10B	10B	2C	2C		2C					3C	3C	3C	3C	S 3
6.1	38E	38E	38E	38E	38E	18D	18D		18D	18D	18D	18D	18D	25D	25D	25D	25D	N 3
6.2	38E	38E	38E	38E	38E	20E	20E		20E	20E	20E	20E	20E	28E	28E	28E	28E	N 4
6.3	38E	38E	38E	38E	38E	18D	18D		18D	18D	18D	18D	18D	25D	25D			N 3
6.4	38D	38D	38D	38D	38D	11D	11D		11D	11D	11D	11D	11D	14D	14D			N 4
7.1	60D	60D	60D	60D	60D	23F	23F		23F	23F	23F	23F	23F	28F			28F	N 1
7.2	60D	60D	60D	60D	60D	18F	18F		18F	18F	18F	18F	18F	25F			25F	N 1
7.3	25D	25D	25D	25D	25D				15E	15E	15E	15E	15E	20E			20E	N 1
7.4	25D	25D	25D	25D	25D				14D	14D	14D	14D	14D	16D			16D	N 2
8.1	25C	25C	25C	25C	25C									30B			30B	O
8.2	13C	13C	13C	13C	13C	21B	21B		21B	21B	21B	21B	21B					O
8.3																		O
9.1														3A			3A	H
10.1																		O

	HSS-E	HSS-E	HSS	HSS-E	HSS-E	HSS-E		
	DIN 208	BS 328	DIN 311	DIN 2180	DIN 219	DIN 217		
	B	B			B			
	H7	H7	k11		H7			
				1:50				
	B161	B101	B121	B954	B955	B956	B957	
	3.00 - 50.00	3.00 - 2"	10.00 - 30.00	5.00 - 30.00	25.00 - 80.00	13.00 - 40.00	N3DRIVER - N9WASHER	
AMG	174	176	178	179	180	181	182	ISO
1.1	■25C	■18C	■18C	●25C	■18C			P 1
1.2	■20C	■14C	■14C	●20C	■14C			P 1
1.3	■16C	■11C	■11C	●16C	■11C			P 2
1.4	■15B	■10B	■10B	●15B	■10B			P 3
1.5	●9B	●5B	●5B	●9B	●5B			P 4
1.6	●5A	●4A	●4A	●5A	●4A			H 1
1.7								H 3
1.8								H 4
2.1	■11C	■8C		■11C	■8C			M 1
2.2	●6B			■6B	●5B			M 3
2.3	●8B			■8B	●6B			M 2
2.4								S 2
3.1	●16E	■14E	■14E		●14E			K 1
3.2	●15D	●11D	●11D					K 2
3.3	●13C	●10C	●10C					K 3
3.4	●11C	●9C	●9C					K 4
4.1	■15C	■11C	■11C	■15C	■11C			S 1
4.2	●9B	●5B		■9B	●5B			S 2
4.3	●5B	●4B		■5B	●4B			S 3
5.1	■8D	●5D		■8D	■5D			S 1
5.2	●5C	●3C		■5C	●3C			S 2
5.3	●3C	●2C		■3C	●2C			S 3
6.1	●25D	●18D		■25D	●18D			N 3
6.2	●28E	■20E		●28E	●20E			N 4
6.3	●25D	●18D						N 3
6.4	●14D	●11D						N 4
7.1		●23F		■28F	●23F			N 1
7.2		●18F		■25F	●18F			N 1
7.3				■20E	●15E			N 1
7.4				■16D	●14D			N 2
8.1				■30B				O
8.2		●21B	●21B		●21B			O
8.3								O
9.1				●3A				H
10.1								O

Materiál	Материал	Materiał	Materiál
Povlak	Покрытие	Pokrycie	Povlak
Standard	Стандарт	Standard	Štandard
Směr otáčení	Направление	Kierunek	Smer otáčania
Použití	Применение	Zastosowanie	Použitie
Stopka	Хвостовик	Chwył	Stopka
Úhel zahloubení	Угол зенковки	Kąt Ostrza	Uhol zahĺbenia
<ul style="list-style-type: none"> ■ vynikající ● dobrý <p>Příklad 10 = řezná rychlost (m/min) +/- 10%</p>	<p>Основное применение Возможное применение</p> <p>Пример: 10 = Скорость резания в м/мин +/- 10%</p>	<p>Najlepsze zastosowanie Dobre zastosowanie</p> <p>Na przykład 10 = prędkość skrawania w m/min +/- 10%</p>	<p>Vynikajúce Dobré</p> <p>Príklad 10 = rezná rýchlosť (m/min) +/- 10%</p>
Kód	Код	Kod	Kód
Rozměrová řada	Ассортимент	Zakres średnic	Rozsah rozmerov

AMG	Česky	Русский	Polski	Slovensky
1.1	magneticky měkká	Автоматная сталь	magnetyczna miękka	Magneticky mäkká oceľ
1.2	konstrukční uhlíkatá	Низкоуглеродистая сталь	konstrukcyjna do nawęglania	Konstruktčná oceľ,uhlíková
1.3	uhlíkatá	Углеродистая нелегированная сталь	węglowa	Uhlíková oceľ
1.4	legovaná	Легированная сталь	stopowa	Legovaná oceľ
1.5	legovaná, tvřená a temperovaná	Легированная сталь после отжига	stopowa-hartowana i odpuszczana	Legovaná oceľ, tvrdená a temperovaná
1.6	legovaná, tvřená a temperovaná	Высоколегированная сталь после отжига	stopowa-hartowana i odpuszczana	Legovaná oceľ, tvrdená a temperovaná
1.7	legovaná, tvřená	Легированная закаленная сталь	stopowa-hartowana	Legovaná oceľ tvrdená
1.8	legovaná, tvřená	Легированная закаленная сталь	stopowa-hartowana	Legovaná oceľ tvrdená, oceľ odolná oproti opotrebovaniu
2.1	automatová	Ферритная нержавеющая сталь	automatowa	Automatová nehrdzavejúca oceľ
2.2	austenitická	Аустенитная нержавеющая сталь	austenityczna	Austenická
2.3	fertická+austenitická	Ферритно-аустенитная нержавеющая сталь	ferrytyczna+austenityczna	Feriticko austenitická nehr. oceľ (Duplex)
2.4	precipitačně tvřená	Сталь дисперсионного твердения	Utwardzane wydzieleniowo	Tvrdená nehr. oceľ
3.1	lamelární	Серый чугун	szare	Sivá liatina
3.2	lamelární	Ковкий чугун	szare	Sivá liatina
3.3	nodulární	Высокопрочный чугун	sferoidalne ciągliwe	Tvárna liatina
3.4	nodulární	Высокопрочный чугун	sferoidalne ciągliwe	Tvárna liatina
4.1	čistý	Технически чистый титан	niestopowy	Čistý titán
4.2	slitiny	Титановые сплавы	stopy tytanu	Zliatiny titánu
4.3	slitiny	Титановые сплавы	stopy tytanu	Zliatiny titánu
5.1	čistý	Технически чистый никель	niestopowy	Čistý nikel
5.2	slitiny	Никелевые сплавы	stopy niklu	Zliatiny niklu
5.3	slitiny	Никелевые сплавы	stopy niklu	Zliatiny niklu
6.1	bronz	Технически чистая медь	niestopowa	Bronz
6.2	β - mosaz, bronz	Бронза	Mosiądz-β,brąz	β - mosadz, bronz
6.3	bronz mosaz	Латунь	Mosiądz CuZn	Mosadz, bronz
6.4	bronz vysokopevnostní	Высокопрочная бронза	Brąz o wysokiej wytrzymałości	Vysokopevnostný bronz
7.1	Al, Mg, tváření	Технически чистый алюминий/магний	Al.,Mg, niestopowe	Al, Mg, tvárnený (čistý)
7.2	Al slitiny, Si<0.5%	Сплавы Al с содержанием Si<0.5%	Al. Stopowe,Si<0,5%	Al zliatiny, Si<0,5%
7.3	Al slitiny, Si>0.5%<10%	Сплавы Al с содержанием 0.5%<Si<10%	Al. Stopowe,Si>0,5%<10%	Al zliatiny, Si>0,5%<10%
7.4	Al slitiny, Si>10%	Сплавы Al с содержанием Si>10%	Al. Stopowe,Si>10%	Al zliatiny, Si>10%
8.1	termoplasty	Термопластики	Tworzywa termoplastyczne	Termoplasty
8.2	termosety	Термореактивные полимеры	Tworzywa termoutwardzalne	Termosety
8.3	zpevněné plasty	Армированные полимеры	Zbrojone tworzywa sztuczne	Spevnené plasty
9.1	cermet (keramika)	Металлокерамика	Cermetale	Cermet (kov-keramika)
10.1	standardní grafit	Технический графит	Grafit standartowy	Grafit

	HM	HSS	HSS	HSS	HSS	HSS	HSS-E	HSS	HSS	HSS	HSS	HSS	HSS-E	HSS-E	
	DIN 335C	DIN 334C	DIN 334C	DIN 334D	DIN 335C	DORMER	DORMER	DIN 335C	DIN 335C	DIN 335C	DIN 335C	DIN 335C	DIN 335C	DORMER	
	G400	G135	G335	G137	G154	G129	G149	G136	G560	G106	G506	G142	G570	G107	
	6.30 - 31.00	6.30 - 25.00	6.30 - 25.00	16.00 - 80.00	6.30 - 25.00	6.00 - 31.50	5.00 - 50.00	4.30 - 31.00	6.30 - 31.00	6.30 - 50.00	6.30 - 50.00	4.80 - 31.00	6.30 - 31.00	6.30 - 20.50	
AMG	183	184	184	185	186	187	188	189	189	189	189	191	191	192	ISO
1.1	■30F	■30F	■50E	■30F	■30F	■30D	■30D	■30F	■50E	■30F	■50E	■30F	●45E	■30F	P 1
1.2	■25E	■25E	■40E	■25E	■25E	■25D	■25D	■25E	■40E	■25E	■40E	■25E	●36E	■25E	P 1
1.3	■20D	■20D	■30D	■20D	■20D	■20C	■20C	■20D	■30D	■20D	■30D	■20D	●20D	■20D	P 2
1.4	■15D	■15D	●20D	■15D	■15D	■15B	■15B	■15D	■20D	■15D	●20D	●15D	■22D	■15D	P 3
1.5	■10B	■10B	●15B	■10B	■10B	●10A	●10A	●10B	■15B	■10B	●15B	■17B	■10B	■10B	P 4
1.6	●6A	●6A	●10B	●6A	●6A	●6A	●6A	●6A	●10B	●6A	●10B	●12B	●6A	●6A	H 1
1.7															H 3
1.8															H 4
2.1	●8C	●8C		●8C	●8C	●8B	●8B	●8C	■8C	●8C		■8C	■17C	●8C	M 1
2.2	●6B	●6B		●6B	●6B	●6A	●6A	●6B	●6B	●6B		■6B	■12B	●6B	M 3
2.3	●4A	●4A		●4A	●4A			●4A	●4A	●4A		■4A	■15A	●4A	M 2
2.4													●10A		S 2
3.1	●25F	●25F	■45F	●25F	●25F	●25D	●25D	●25F	■45F	●25F	■45F		●40C	●25F	K 1
3.2	●15D	●15D	■35D	●15D	●15D	●15C	●15C	●15D	■35D	●15D	■35D		●32C	●15D	K 2
3.3	●12C	●12C	■30C	●12C	●12C	●12A	●12A	●12C	■30C	●12C	■30C		●27C	●12C	K 3
3.4	●8C	●8C	■30C	●8C	●8C	●8A	●8A	●8C	■30C	●8C	■30C		●24C	●8C	K 4
4.1	■12C	■12C	●20C	■12C	■12C	■12B	■12B	■12C	●20C	■12C	●20C	■12C		■12C	S 1
4.2	■10A	■10A	●15A	■10A	■10A	■10A	■10A	■10A	●15A	■10A	●15A	●10A		■10A	S 2
4.3	■8A	■8A	●10A	■8A	■8A	●8A	●8A	●8A	●10A	■8A	●10A			■8A	S 3
5.1	■12C	■12C	●20C	■12C	■12C	■12B	■12B	■12C	●20C	■12C	●20C	■12C		■12C	S 1
5.2	■6B	■6B	●10B	■6B	■6B	■6A	■6A	■6B	■10B	■6B	●10B	●6B	●6A	■6B	S 2
5.3	■4A	■4A	●6A	■4A	■4A	●4A	●4A	●4A	■6A	■4A	●6A	●4A	●4A	■4A	S 3
6.1	■25D	■25D	●40D	■25D	■25D	■25B	■25B	■25D	●40D	■25D	■25D	■25D	■25D	■25D	N 3
6.2	■20F	■20F	●30F	■20F	■20F	■20C	■20C	■20F	●30F	■20F	●30F	■20F	●30F	■20F	N 4
6.3	■25F	■25F	●40F	■25F	■25F	■25C	■25C	■25F	●40F	■25F	●40F	●25F	●40F	■25F	N 3
6.4	●10D	●10D	●15D	●10D	●10D	●10B	●10B	●10D	●15D	●10D	●15D	●15D	●15D	●10D	N 4
7.1	■30G	■30G	■50G	■30G	■30G	■30D	■30D	■30G	■50G	■30G	■50G	■30G	●45G	■30G	N 1
7.2	■25F	■25F	■40F	■25F	■25F	■25C	■25C	■25F	●40F	■25F	■40F	■25F	●36F	●25F	N 1
7.3	●20F	●20F	■30F	●20F	●20F	●20C	●20C	●20F	■30F	●20F	■30F	●20F	●27F	●20F	N 1
7.4	●10F	●10F	■15F	●10F	●10F	●10C	●10C	●10F	■15F	●10F	■15F	●10F	●13F	●10F	N 2
8.1	●30G	●30G	●50G	●30G	●30G	●30D	●30D	■30G	●50G	●30G	●50G	■30G		●30G	O
8.2	●20G	●20G	●30G	●20G	●20G	●20D	●20D	●20G	●30G	●20G	●30G	■20G		●20G	O
8.3															O
9.1															H
10.1															O

HSS	HSS	HSS	HSS	HSS	HSS	HSS
DORMER	DIN 335A	DIN 335D	DIN 335D	DIN 335C	DORMER	DIN 373
90°	90°	90°	90°	100°	20°	180°
G600	G132	G138	G338	G171	G314	G125
6.30 - 25.00	8.00 - 20.00	25.00 - 80.00	25.00 - 63.00	6.30 - 25.00	4.00 - 9.00	6.50 - 20.00
						G236
						Set

AMG	193	194	195	195	196	197	198	199	ISO
1.1	■22F		■30F	■50F	■50E	■30D	■30E		P 1
1.2	■17E		■25E	■40E	■40E	■25D	■25E		P 1
1.3	■15D	●20E	■20D	■30D	■30D	■20C	■20D		P 2
1.4	■12D	●15D	■15D	■20D	●20D	■15B	●15D		P 3
1.5	■8B	■10D	■10B	■15B	●15B	●10A	●10C		P 4
1.6	●6A	■6B	●6A	●10A	●10B	●6A	●6C		H 1
1.7									H 3
1.8									H 4
2.1	●8C		●8C			●8B	■8D		M 1
2.2	●6B		●6B			●6A	●6C		M 3
2.3	●4A	●4B	●4A			●4A			M 2
2.4									S 2
3.1	●25F		●25F	■45F	■45F	●25D	■25E		K 1
3.2	●15D		●15D	■35D	■35D	●15C	■15E		K 2
3.3	●12C		●12C	■30C	■30C	●12A	●12D		K 3
3.4		■8D	●8C	■30C	■30C	●8A	●8C		K 4
4.1			■12C	●20C	●20C	■12B	●12E		S 1
4.2		■8A	■10A	●15A	●15A	■10A	●10E		S 2
4.3		■8A	■8A	●10A	●10A	■8A	●8E		S 3
5.1			■12C	●20C	●20C	■12B	●12E		S 1
5.2		■6C	■6B	●10B	●10B	■6A	●6C		S 2
5.3		■4B	■4A	●6A	●6A	■4A	●4E		S 3
6.1	●25D		■25D	●40D	●40D	■25B	●25C		N 3
6.2	●20F		■20F	●30F	●30F	■20C	●20C		N 4
6.3	●25F		■25F	●40F	●40F	■25C	●25C		N 3
6.4	●10D	■10F	●10D	●15D	●15D	●10B			N 4
7.1	■30G		●30G	■50G	■50G	■30D	■30G		N 1
7.2	●25F		●25F	■40F	■40F	■25C	■25G		N 1
7.3	●20F		●20F	■30F	■30F	●20C	●20G		N 1
7.4	●10F		●10F	■15F	■15F	●10C	●10E		N 2
8.1			●30G	●50G	●50G	■30D	■30C		O
8.2			●20G	●30G	●30G	■20D	●20C		O
8.3		●5G							O
9.1									H
10.1									O

	Ø mm												
	1,5	2	3	5	8	10	12	16	20	25	30	40	50
A	0,045	0,055	0,078	0,100	0,150	0,170	0,185	0,220	0,250	0,280	0,320	0,390	0,440
B	0,055	0,072	0,110	0,150	0,180	0,210	0,240	0,280	0,310	0,360	0,400	0,500	0,550
C	0,065	0,085	0,135	0,185	0,220	0,260	0,285	0,335	0,390	0,440	0,480	0,600	0,680
D	0,080	0,110	0,160	0,200	0,270	0,320	0,360	0,410	0,470	0,540	0,600	0,730	0,850
E	0,100	0,140	0,180	0,250	0,350	0,390	0,430	0,500	0,530	0,640	0,750	0,910	1,100
F	0,140	0,180	0,260	0,350	0,440	0,500	0,550	0,630	0,700	0,800	0,930	1,200	1,500

mm/REV ± 15 %

	Ø mm										
	6	8	10	16	20	25	32	40	60	80	
A	0.03	0.04	0.05	0.06	0.08	0.09	0.10	0.12	0.14	0.16	
B	0.04	0.05	0.06	0.08	0.10	0.12	0.14	0.16	0.18	0.20	
C	0.05	0.06	0.08	0.10	0.12	0.14	0.16	0.18	0.20	0.22	
D	0.06	0.08	0.10	0.12	0.15	0.18	0.20	0.22	0.25	0.28	
E	0.08	0.10	0.12	0.15	0.18	0.20	0.25	0.27	0.30	0.32	
F	0.09	0.11	0.13	0.16	0.19	0.21	0.26	0.29	0.33	0.36	
G	0.10	0.12	0.15	0.18	0.20	0.22	0.28	0.32	0.36	0.40	
H	0.12	0.15	0.18	0.20	0.22	0.25	0.30	0.35	0.40	0.45	

mm/REV

• Základní doporučení pro úběr materiálu při předvrtávání děr • Рекомендованные припуски для развёртывания • Podstawowe wskazówki dotyczące usuwania materiału przy wierceniu pod rozwiertak • Základné odporúčanie pre úber materiálu pri predvrtávaní dier

	Ø (mm)					
	3 - 5mm	5.1 - 10mm	10.1 - 20mm	20.1 - 30mm	> 30mm	
1.1	0.1-0.2	0.2	0.2-0.3	0.3-0.4	0.4-0.5	P 1
1.2	0.1-0.2	0.2	0.2-0.3	0.3-0.4	0.4-0.5	P 1
1.3	0.1-0.2	0.2	0.2-0.3	0.3-0.4	0.4-0.5	P 2
1.4	0.1-0.2	0.2	0.2	0.3	0.3-0.4	P 3
1.5	0.1-0.2	0.2	0.2	0.3	0.3-0.4	P 4
1.6	0.1-0.2	0.2	0.2	0.3	0.3-0.4	H 1
1.7	0.1-0.2	0.2	0.2	0.3	0.3-0.4	H 3
1.8	0.1-0.2	0.2	0.2	0.3	0.3-0.4	H 4
2.1	0.1-0.2	0.2	0.2	0.3	0.3-0.4	M 1
2.2	0.1-0.2	0.2	0.2	0.3	0.3-0.4	M 3
2.3	0.1-0.2	0.2	0.2	0.3	0.3-0.4	M 2
2.4	0.1-0.2	0.2	0.2	0.3	0.3-0.4	S 2
3.1	0.1-0.2	0.2	0.2-0.3	0.3-0.4	0.4-0.5	K 1
3.2	0.1-0.2	0.2	0.2-0.3	0.3-0.4	0.4-0.5	K 2
3.3	0.1-0.2	0.2	0.3	0.4	0.5	K 3
3.4	0.1-0.2	0.2	0.3	0.4	0.5	K 4
4.1	0.1-0.2	0.2	0.2-0.3	0.3-0.4	0.3-0.4	S 1
4.2	0.1-0.2	0.2	0.2	0.3	0.3-0.4	S 2
4.3	0.1-0.2	0.2	0.2	0.3	0.3-0.4	S 3
5.1	0.1-0.2	0.2	0.2-0.3	0.3-0.4	0.4-0.5	S 1
5.2	0.1-0.2	0.2	0.2	0.3	0.3-0.4	S 2
5.3	0.1-0.2	0.2	0.2	0.3	0.3-0.4	S 3
6.1	0.1-0.2	0.2-0.3	0.3-0.4	0.4-0.5	0.5	N 3
6.2	0.1-0.2	0.2	0.2-0.3	0.3	0.3-0.4	N 4
6.3	0.1-0.2	0.2	0.2-0.3	0.3	0.3-0.4	N 3
6.4	0.1-0.2	0.2	0.2-0.3	0.3	0.3-0.4	N 4
7.1	0.1-0.2	0.2-0.3	0.3-0.4	0.4-0.5	0.5	N 1
7.2	0.1-0.2	0.2-0.3	0.3-0.4	0.4-0.5	0.5	N 1
7.3	0.1-0.2	0.2-0.3	0.3-0.4	0.4-0.5	0.5	N 1
7.4	0.1-0.2	0.2-0.3	0.3-0.4	0.4-0.5	0.5	N 2
8.1	0.1-0.2	0.3	0.4	0.4-0.5	0.5	O
8.2	0.1-0.2	0.2	0.2	0.3	0.3-0.4	O
8.3	0.1-0.2	0.2	0.2	0.3	0.3-0.4	O
9.1	0.1-0.2	0.2	0.2	0.3	0.3-0.4	H
10.1	0.1-0.2	0.2	0.2-0.3	0.3-0.4	0.4-0.5	O

Pro stavitelné výstružníky nebo výstružníky s břity zmenšete úběr materiálu o 30%. Pro výstružníky s rychlou šroubovicí zvýšte o 50% / Для регулируемых разверток снижение припуска на 30%. Для скоростных разверток увеличить на 50% / Dla rozwiertaków nastawnych zmniejsz usuwanie materiału o 30%,zostaw większy zapas.Dla rozwiertaków mocno skrętnych zwiększ o 50%,zostaw mniejszy zapas / Pre nastaviteľné výstružníky alebo výstružníky s britom zmenšite úber materiálu o 30%. Pre výstružníky s rýchlou skrutkovicou zvýšte o 50%.

B400

- Výstružník strojní extrémně nerovnoměrné členění
- Машинные развертки, неравномерный шаг
- Rozwiertak maszynowy o przemiennych ostrzach
- Výstružník strojný extrémne nerovnomerné členenie

B400	▪	1.5	1.6	3.1	3.2	3.3	3.4	4.1	4.2	4.3	5.1	5.2	5.3	6.1	6.2	6.3	6.4	7.1	7.2	7.3	7.4	
		8.1	8.2																			
	•	1.1	1.2	1.3	1.4																	

B400

HM



DIN
8093



B

H7

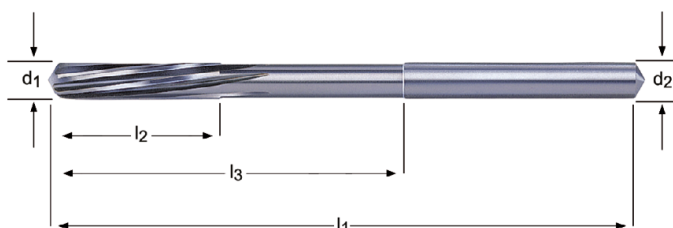

B400



1.00 - 20.00

d_1 Ø mm	l_1 mm	l_2 mm	l_3 mm	z	d_2 Ø h_7 mm	B400
1.0	34	6	15	3	1.0	B4001.0 ¹⁾
1.2	38	8	16.5	3	1.2	B4001.2 ¹⁾
1.4	40	8	18	3	1.4	B4001.4 ¹⁾
1.5	40	8	18	3	1.5	B4001.5 ¹⁾
1.6	49	11	26	3	1.6	B4001.6 ¹⁾
1.8	49	11	25	4	1.8	B4001.8 ¹⁾
2.0	49	11	24	4	2.0	B4002.0 ¹⁾
2.2	57	15	30	4	2.2	B4002.2 ¹⁾
2.5	57	15	28	4	2.5	B4002.5 ¹⁾
2.8	61	15	32	4	2.8	B4002.8 ¹⁾
3.0	61	15	30	6	3.0	B4003.0 ¹⁾
3.2	70	18	33	6	3.2	B4003.2 ¹⁾
3.5	70	18	33	6	3.5	B4003.5 ¹⁾
4.0	75	19	44	6	4.0	B4004.0 ¹⁾
4.5	80	21	46	6	4.5	B4004.5 ¹⁾
5.0	86	23	53	6	5.0	B4005.0 ¹⁾
5.5	93	26	56	6	5.6	B4005.5 ¹⁾
6.0	93	26	56	6	5.6	B4006.0 ¹⁾
6.5	101	28	63	6	6.3	B4006.5 ²⁾
7.0	109	31	69	6	7.1	B4007.0 ²⁾
8.0	117	33	75	6	8.0	B4008.0 ²⁾
9.0	125	36	81	6	9.0	B4009.0 ²⁾
10.0	133	38	87	6	10.0	B40010.0 ²⁾
12.0	151	44	105	6	10.0	B40012.0 ²⁾
14.0	160	47	110	8	12.5	B40014.0 ²⁾
16.0	170	52	120	8	12.5	B40016.0 ²⁾
18.0	182	56	130	6	14.0	B40018.0 ³⁾
20.0	195	60	137	6	16.0	B40020.0 ³⁾

¹⁾ slinutý karbid / Твердый сплав / Pełno węglkowy / spekaný karbid

²⁾ karbidová hlava / Твердосплавная головка / Część skrawająca z węglika / karbidová hlava

³⁾ karbidovaný / С напайными пластинами / Włutowana płytka węglkowa / karbidovaný

B481

- NC- setinový výstružník pro vysoce přesné upnutí
- NC- Развертка для станков с ЧПУ
- NC- Rozwiertak precyzyjny przeznaczony do mocowania w dokładnych uchwytach
- NC- stotinový výstružník pre vysoko presné upnutie

Extrémně nerovnoměrné členění
Неравномерный шаг
Nierównomierna podziałka
Extrémne nerovnomerné členenie

B481	▪	1.5	1.6	3.1	3.2	3.3	3.4	4.1	4.2	4.3	5.1	5.2	5.3	6.1	6.2	6.3	6.4	7.1	7.2	7.3	7.4	
		8.1	8.2																			
	•	1.1	1.2	1.3	1.4																	

B481

HM



DIN
8093



DIN
6535HA

B

Ø.95-5.5
0,+0.004
Ø5.51-12
0,+0.005



B481



0.98 - 12.05

d_1 Ø mm	l_1 mm	l_2 mm	l_3 mm	z	d_2 Ø h_6 mm	B481
0.98	49.5	6	21.5	3	4	B4810.98
0.99	49.5	6	21.5	3	4	B4810.99
1.00	49.5	6	21.5	3	4	B4811.00
1.01	49.5	6	21.5	3	4	B4811.01
1.02	49.5	6	21.5	3	4	B4811.02
1.03	49.5	9	21.5	3	4	B4811.03
1.48	49	9	21	3	4	B4811.48
1.49	49	9	21	3	4	B4811.49
1.50	49	9	21	3	4	B4811.50
1.51	49	9	21	3	4	B4811.51
1.52	49	9	21	3	4	B4811.52
1.53	49	9	21	3	4	B4811.53
1.98	49	12	21	4	4	B4811.98
1.99	49	12	21	4	4	B4811.99
2.00	49	12	21	4	4	B4812.00
2.01	49	12	21	4	4	B4812.01
2.02	49	12	21	4	4	B4812.02
2.03	49	12	21	4	4	B4812.03
2.48	59	16	31	4	4	B4812.48
2.49	59	16	31	4	4	B4812.49
2.50	59	16	31	4	4	B4812.50
2.51	59	16	31	4	4	B4812.51
2.52	59	16	31	4	4	B4812.52
2.53	59	16	31	4	4	B4812.53
2.97	62.5	17	35	6	4	B4812.97
2.98	62.5	17	35	6	4	B4812.98
2.99	62.5	17	35	6	4	B4812.99
3.00	62.5	17	35	6	4	B4813.00
3.01	62.5	17	35	6	4	B4813.01
3.02	62.5	17	35	6	4	B4813.02
3.03	62.5	17	35	6	4	B4813.03
3.97	75	19	47	6	4	B4813.97
3.98	75	19	47	6	4	B4813.98
3.99	75	19	47	6	4	B4813.99
4.00	75	19	47	6	4	B4814.00
4.01	75	19	47	6	4	B4814.01
4.02	75	19	47	6	4	B4814.02
4.03	75	19	47	6	4	B4814.03

d_1 Ø mm	l_1 mm	l_2 mm	l_3 mm	z	d_2 Ø h_6 mm	B481
4.97	86	23	50	6	6	B4814.97
4.98	86	23	50	6	6	B4814.98
4.99	86	23	50	6	6	B4814.99
5.00	86	23	50	6	6	B4815.00
5.01	86	23	50	6	6	B4815.01
5.02	86	23	50	6	6	B4815.02
5.03	86	23	50	6	6	B4815.03
5.97	93	26	57	6	6	B4815.97
5.98	93	26	57	6	6	B4815.98
5.99	93	26	57	6	6	B4815.99
6.00	93	26	57	6	6	B4816.00
6.01	93	26	57	6	6	B4816.01
6.02	93	26	57	6	6	B4816.02
6.03	93	26	57	6	6	B4816.03
7.97	117	33	81	6	8	B4817.97
7.98	117	33	81	6	8	B4817.98
7.99	117	33	81	6	8	B4817.99
8.00	117	33	81	6	8	B4818.00
8.01	117	33	81	6	8	B4818.01
8.02	117	33	81	6	8	B4818.02
8.03	117	33	81	6	8	B4818.03
8.04	117	33	81	6	8	B4818.04
9.97	133	38	93	6	10	B4819.97
9.98	133	38	93	6	10	B4819.98
9.99	133	38	93	6	10	B4819.99
10.00	133	38	93	6	10	B48110.00
10.01	133	38	93	6	10	B48110.01
10.02	133	38	93	6	10	B48110.02
10.03	133	38	93	6	10	B48110.03
10.04	133	38	93	6	10	B48110.04
10.05	133	38	93	6	10	B48110.05
11.97	151	44	106	6	12	B48111.97
11.98	151	44	106	6	12	B48111.98
11.99	151	44	106	6	12	B48111.99
12.00	151	44	106	6	12	B48112.00
12.01	151	44	106	6	12	B48112.01
12.02	151	44	106	6	12	B48112.02
12.03	151	44	106	6	12	B48112.03
12.04	151	44	106	6	12	B48112.04
12.05	151	44	106	6	12	B48112.05

- B441**
- Výstružník strojní extrémně nerovnoměrné členění
 - Машинные развертки, неравномерный шаг
 - Rozwiertak maszynowy o przemiennych ostrzach
 - Výstružník strojný extrémne nerovnomerné členenie

B441	▪	1.5	1.6	3.1	3.2	3.3	3.4	4.1	4.2	4.3	5.1	5.2	5.3	6.1	6.2	6.3	6.4	7.1	7.2	7.3	7.4	
		8.1	8.2																			
	•	1.1	1.2	1.3	1.4																	

B441

HM

DIN
8050

A

H7

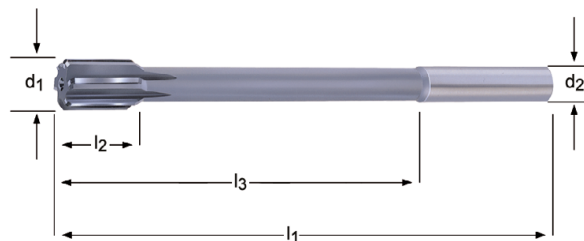

d_1 Ø mm	l_1 mm	l_2 mm	l_3 mm	z	d_2 Ø _{h9} mm	B441
10.0	133	19	87	6	10	B44110.0 ³⁾
11.0	142	19	96	6	10	B44111.0 ³⁾
12.0	151	19	105	6	10	B44112.0 ³⁾
13.0	151	19	105	6	10	B44113.0 ³⁾
14.0	160	19	110	6	12.5	B44114.0 ³⁾
15.0	162	19	112	6	12.5	B44115.0 ³⁾
16.0	170	22	120	6	12.5	B44116.0 ³⁾
17.0	175	22	123	6	14	B44117.0 ³⁾
18.0	182	22	130	6	14	B44118.0 ³⁾
19.0	189	22	131	6	16	B44119.0 ³⁾
20.0	195	22	137	6	16	B44120.0 ³⁾

³⁾ karbidovaný / С напайными пластинами / Wlutowana płytka węglkowa / karbidovaný

- B411**
- Výstružník strojní extrémně nerovnoměrné členění
 - Машинные развертки, неравномерный шаг
 - Rozwiertak maszynowy o przemiennych ostrzach
 - Výstružník strojný extrémne nerovnomerné členenie

B411	▪	1.5	1.6	3.1	3.2	3.3	3.4	4.1	4.2	4.3	5.1	5.2	5.3	6.1	6.2	6.3	6.4	7.1	7.2	7.3	7.4	
		8.1	8.2																			
		•	1.1	1.2	1.3	1.4																

B411

HM

DIN
8094

B

H7



d_1 Ø mm	l_1 mm	l_2 mm	l_3 mm	z	MK	B411
5.0	133	23	67.5	6	1	B4115.0 ²⁾
6.0	138	26	72.5	6	1	B4116.0 ²⁾
7.0	150	31	84.5	6	1	B4117.0 ²⁾
8.0	156	33	90.5	6	1	B4118.0 ²⁾
9.0	162	36	96.5	6	1	B4119.0 ²⁾
10.0	168	38	102.5	6	1	B41110.0 ²⁾
12.0	182	44	116.5	6	1	B41112.0 ²⁾
14.0	189	47	123.5	8	1	B41114.0 ²⁾
15.0	204	50	124	8	2	B41115.0 ²⁾
16.0	210	52	130	8	2	B41116.0 ²⁾
17.0	214	54	134	6	2	B41117.0 ³⁾
18.0	219	56	139	6	2	B41118.0 ³⁾
19.0	223	58	143	6	2	B41119.0 ³⁾
20.0	228	60	148	6	2	B41120.0 ³⁾
22.0	237	64	157	6	2	B41122.0 ³⁾
24.0	268	68	169	8	3	B41124.0 ³⁾
25.0	268	68	169	8	3	B41125.0 ³⁾
26.0	273	70	174	8	3	B41126.0 ³⁾
30.0	281	73	182	8	3	B41130.0 ³⁾

²⁾ karbidová hlava / Твердосплавная головка / Część skrawająca z węglika / karbidová hlava

³⁾ karbidovaný / С напайными пластинами / Włutowana płytką węglkowa / karbidovaný

- B442**
- Výstružník strojní extrémně nerovnoměrné členění
 - Машинные развертки, неравномерный шаг
 - Rozwiertak maszynowy o przemiennych ostrzach
 - Výstružník strojný extrémne nerovnomerné členenie

B442	▪	1.5	1.6	3.1	3.2	3.3	3.4	4.1	4.2	4.3	5.1	5.2	5.3	6.1	6.2	6.3	6.4	7.1	7.2	7.3	7.4	
		8.1	8.2																			
	•	1.1	1.2	1.3	1.4																	

B442

HM		DIN 8051			A	H7	
----	--	----------	--	--	---	----	--

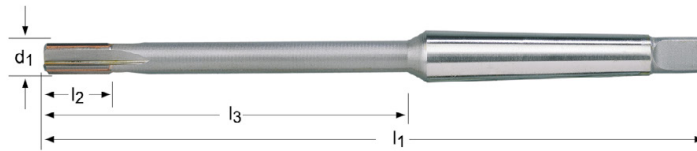

d_1 Ø mm	l_1 mm	l_2 mm	l_3 mm	z	MK	B442
10.0	168	19	102.5	6	1	B44210.0
12.0	182	19	116.5	6	1	B44212.0
14.0	189	19	123.5	6	1	B44214.0
15.0	204	19	124	6	2	B44215.0
16.0	210	22	130	6	2	B44216.0
17.0	214	22	134	6	2	B44217.0
18.0	219	22	139	6	2	B44218.0
19.0	223	22	143	6	2	B44219.0
20.0	228	22	148	6	2	B44220.0

B100

- Výstružník ruční
- Коническая ручная развертка для обработки конуса Морзе
- Rozwiertak ręczny
- Výstružník ručný

d2=d1 tolerance e9
 d2=d1 с допуском e9
 d2=d1 z tolerancją e9
 d2=d1 tolerancia e9

B100	▪	1.1	1.2	1.3	1.4	2.1	3.1	4.1	6.2								
	•	1.5	1.6	3.2	3.3	3.4	4.2	4.3	5.1	5.2	5.3	6.1	6.3	6.4	7.1	7.2	8.2

B100 HSS ST DIN 206 B H7



B100



1.50 - 50.00

d ₁ Ø Inch	d ₁ Ø mm	l ₁ mm	l ₂ mm	l ₃ mm	z	□ a mm	B100
	1.50	41	20	5	3	1.12	B1001.5
1/16	1.59	41	20	5	3	1.12	B1001/16
	1.60	44	21	5	3	1.25	B1001.6
5/64	1.98	47	23	6	4	1.40	B1005/64
	2.00	50	25	6	4	1.60	B1002.0
3/32	2.38	54	27	7	4	1.80	B1003/32
	2.50	58	29	7	4	2.10	B1002.5
7/64	2.78	62	31	8	6	2.10	B1007/64
	3.00	62	31	8	6	2.40	B1003.0
1/8	3.18	66	33	8	6	2.40	B1001/8
	3.20	66	33	8	6	2.40	B1003.2
	3.50	71	35	9	6	2.70	B1003.5
9/64	3.57	71	35	9	6	2.70	B1009/64
5/32	3.97	76	38	10	6	3.00	B1005/32
	4.00	76	38	10	6	3.00	B1004.0
11/64	4.37	81	41	10	6	3.40	B10011/64
	4.50	81	41	10	6	3.40	B1004.5
3/16	4.76	87	44	11	6	3.80	B1003/16
	5.00	87	44	11	6	3.80	B1005.0
13/64	5.16	87	44	11	6	3.80	B10013/64
	5.50	93	47	12	6	4.30	B1005.5
7/32	5.56	93	47	12	6	4.30	B1007/32
15/64	5.95	93	47	12	6	4.90	B10015/64
	6.00	93	47	12	6	4.90	B1006.0
1/4	6.35	100	50	13	6	4.90	B1001/4
	6.50	100	50	13	6	4.90	B1006.5
17/64	6.75	107	54	14	6	5.50	B10017/64
	7.00	107	54	14	6	5.50	B1007.0
9/32	7.14	107	54	14	6	6.20	B1009/32
	7.50	107	54	14	6	6.20	B1007.5
19/64	7.54	115	58	15	6	6.20	B10019/64
5/16	7.94	115	58	15	6	6.20	B1005/16
	8.00	115	58	15	6	6.20	B1008.0
21/64	8.33	115	58	15	6	7.00	B10021/64
	8.50	115	58	15	6	7.00	B1008.5
11/32	8.73	124	62	16	6	7.00	B10011/32
	9.00	124	62	16	6	7.00	B1009.0
23/64	9.13	124	62	16	6	8.00	B10023/64
	9.50	124	62	16	6	8.00	B1009.5
3/8	9.52	124	62	17	6	8.00	B1003/8

d₁ Ø Inch	d₁ Ø mm	l₁ mm	l₂ mm	l₃ mm	z	□ a mm	B100
25/64	9.92	133	66	17	6	8.00	B10025/64
	10.00	133	66	17	6	8.00	B10010.0
13/32	10.32	133	66	17	6	8.00	B10013/32
	10.50	133	66	17	6	8.00	B10010.5
	11.00	142	71	18	6	9.00	B10011.0
7/16	11.11	142	71	18	6	9.00	B1007/16
	11.50	142	71	18	6	9.00	B10011.5
	12.00	152	76	19	6	9.00	B10012.0
	12.50	152	76	19	6	10.00	B10012.5
1/2	12.70	152	76	19	6	10.00	B1001/2
	13.00	152	76	19	6	10.00	B10013.0
17/32	13.49	163	81	20	8	11.00	B10017/32
	13.50	163	81	20	8	11.00	B10013.5
	14.00	163	81	20	8	11.00	B10014.0
9/16	14.29	163	81	20	8	11.00	B1009/16
	14.50	163	81	20	8	11.00	B10014.5
	15.00	163	81	20	8	12.00	B10015.0
19/32	15.08	163	81	22	8	12.00	B10019/32
5/8	15.88	175	87	22	8	12.00	B1005/8
	16.00	175	87	22	8	12.00	B10016.0
	17.00	175	87	22	8	13.00	B10017.0
11/16	17.46	188	93	23	8	14.50	B10011/16
	18.00	188	93	23	8	14.50	B10018.0
	19.00	188	93	23	8	14.50	B10019.0
3/4	19.05	188	93	25	8	14.50	B1003/4
	20.00	201	100	25	8	16.00	B10020.0
13/16	20.64	201	100	25	8	16.00	B10013/16
	21.00	201	100	25	8	16.00	B10021.0
	22.00	215	107	27	8	18.00	B10022.0
7/8	22.22	215	107	27	8	18.00	B1007/8
	23.00	215	107	27	8	18.00	B10023.0
	24.00	231	115	29	8	18.00	B10024.0
	25.00	231	115	29	8	20.00	B10025.0
1"	25.40	231	115	29	8	20.00	B1001
	26.00	231	115	29	8	20.00	B10026.0
	27.00	247	124	31	10	22.00	B10027.0
	28.00	247	124	31	10	22.00	B10028.0
	29.00	247	124	31	10	22.00	B10029.0
	30.00	247	124	31	10	24.00	B10030.0
	31.00	265	133	33	10	24.00	B10031.0
	32.00	265	133	33	10	24.00	B10032.0
	33.00	265	133	33	10	26.00	B10033.0
	34.00	284	142	36	10	26.00	B10034.0
	35.00	284	142	36	10	29.00	B10035.0
	36.00	284	142	36	10	29.00	B10036.0
	37.00	284	142	36	10	29.00	B10037.0
	38.00	305	152	38	10	29.00	B10038.0
	39.00	305	152	38	10	32.00	B10039.0
	40.00	305	152	38	10	32.00	B10040.0
	45.00	326	163	41	12	35.00	B10045.0
	50.00	347	174	44	12	39.00	B10050.0

- B334**
- Výstružník ruční, rychle stavitelný
 - Регулируемые ручные развертки
 - Rozwiertak ręczny rozprężny - prosty
 - Výstružník ručný, rychle nastaviteľný

B334	▪	1.1	1.2	1.3	1.4	2.1	3.1	4.1	6.2								
	•	1.5	1.6	3.2	3.3	3.4	4.2	4.3	5.1	5.2	5.3	6.1	6.3	6.4	7.1	7.2	8.2

B334 HSS

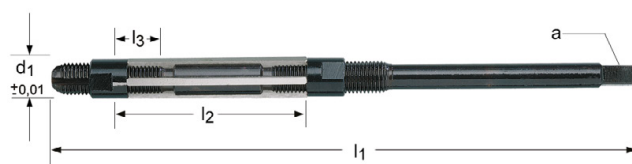

B334



N000 - N16

Nr.	d min-max mm	l ₁ mm	l ₂ mm	l ₃ mm	z	∇ a mm	B334
000	6.4 - 7.2	110	32	7	4	3.0	B334000
00	7.2 - 8.0	110	32	7	4	3.4	B33400
0	8.0 - 9.0	115	34	9	5	3.8	B3340
1	9.0 - 10.0	115	34	9	5	4.3	B3341
2	10.0 - 11.0	115	34	9	5	4.9	B3342
3	11.0 - 12.0	125	35	9	5	4.9	B3343
4	12.0 - 13.5	135	41	9	5	6.2	B3344
5	13.5 - 15.5	146	50	12	5	7.0	B3345
6	15.5 - 18.0	166	60	12	5	8.0	B3346
7	18.0 - 21.0	178	65	15	5	9.0	B3347
8	21.0 - 24.0	195	76	15	5	11.0	B3348
9	24.0 - 27.5	218	82	18	5	12.0	B3349
10	27.5 - 31.5	245	86	18	5	14.5	B33410
11	31.5 - 37.0	280	98	18	6	18.0	B33411
12	37.0 - 45.0	325	108	20	6	20.0	B33412
13	45.0 - 55.0	370	118	20	6	26.0	B33413
14	55.0 - 67.0	400	125	20	6	32.0	B33414
15	67.0 - 80.0	435	140	23	8	39.0	B33415
16	80.0 - 95.0	475	155	23	8	49.0	B33416

- B335**
- Výstružník ruční, rychle stavitelný - náhradní díly (B334)
 - Комплектующие для регулируемых ручных разверток B334
 - Rozwiertak rozprężny ręczny części zamienne (B 334)
 - Výstružník ručný, rychle nastaviteľný-náhradné diely (B334)



BLADES



NUT



Nr.	B335
000	B335000BLADES
000	B335000NUT
00	B33500BLADES
00	B33500NUT
0	B3350BLADES
0	B3350NUT
1	B3351BLADES
1	B3351NUT
2	B3352BLADES
2	B3352NUT
3	B3353BLADES
3	B3353NUT
4	B3354BLADES
4	B3354NUT
5	B3355BLADES
5	B3355NUT
6	B3356BLADES
6	B3356NUT
7	B3357BLADES
7	B3357NUT
8	B3358BLADES
8	B3358NUT
9	B3359BLADES
9	B3359NUT
10	B33510BLADES
10	B33510NUT
11	B33511BLADES
11	B33511NUT
12	B33512BLADES
12	B33512NUT
13	B33513BLADES
13	B33513NUT
14	B33514BLADES
14	B33514NUT
15	B33515BLADES
15	B33515NUT
16	B33516BLADES
16	B33516NUT

B901

- Výstružník strojní
- Машинная развертка
- Rozwiertak maszynowy
- Výstružník strojný

d2=d1 - 0.025
d2=d1 - 0.025
d2=d1 - 0.025
d2=d1 - 0.025

B901	▪	1.1	1.2	1.3	1.4	2.1	3.1	4.1	6.2											
	•	1.5	1.6	3.2	3.3	3.4	4.2	4.3	5.1	5.2	5.3	6.1	6.3	6.4	7.1	7.2	8.2			

B901 HSS-E



BS
328



B

H7



B901



1.50 - 1/2

d ₁ Ø Inch	d ₁ Ø mm	l ₁ mm	l ₂ mm	z	B901
	1.50	44	21	4	B9011.5
1/16	1.59	44	21	4	B9011/16
	2.00	50	25	4	B9012.0
3/32	2.38	58	29	4	B9013/32
	2.50	58	29	4	B9012.5
	3.00	62	31	4	B9013.0
1/8	3.18	66	33	4	B9011/8
	3.50	71	35	4	B9013.5
5/32	3.97	76	38	6	B9015/32
	4.00	76	38	6	B9014.0
	4.50	81	41	6	B9014.5
3/16	4.76	87	44	6	B9013/16
	5.00	87	44	6	B9015.0
13/64	5.16	87	44	6	B90113/64
	5.50	93	47	6	B9015.5
7/32	5.56	93	47	6	B9017/32
15/64	5.95	93	47	6	B90115/64
	6.00	93	47	6	B9016.0
1/4	6.35	100	50	6	B9011/4
	7.00	107	54	6	B9017.0
9/32	7.14	107	54	6	B9019/32
5/16	7.94	115	58	6	B9015/16
	8.00	115	58	6	B9018.0
	9.00	124	62	6	B9019.0
3/8	9.52	133	66	6	B9013/8
	10.00	133	66	6	B90110.0
	11.00	142	71	6	B90111.0
7/16	11.11	142	71	6	B9017/16
	12.00	152	76	6	B90112.0
1/2	12.70	152	76	6	B9011/2

- B301**
- Výstružník ruční na kuželové kolíky
 - Коническая ручная развертка
 - Rozwiertak ręczny pod kołki
 - Výstružník ručný na kužeľové kolíky

B301	▪	1.1	1.2	1.3	1.4	2.1	3.1	4.1	6.2										
	•	1.5	1.6	2.2	2.3	3.2	3.3	3.4	4.2	4.3	5.1	6.1	6.3	6.4	7.1	7.2	7.3	7.4	8.2

B301 HSS

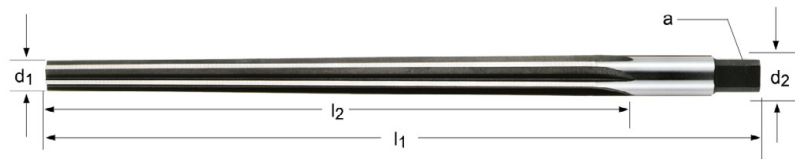

nom Ø	d ₁ Ø mm	l ₁ mm	l ₂ mm	z	∠ a mm	d ₂ Ø mm	B301
1/16	1.10	51	25	4	1.2	1.63	B3011/16 ⁴⁾
5/64	1.50	51	25	4	1.6	2.03	B3015/64 ⁴⁾
3/32	1.75	57	32	4	2.0	2.41	B3013/32 ⁴⁾
7/64	2.03	64	38	4	2.2	2.82	B3017/64 ⁴⁾
1/8	2.30	70	44	4	2.5	3.23	B3011/8 ⁴⁾
9/64	2.64	73	48	4	2.8	3.63	B3019/64 ⁴⁾
5/32	2.95	76	51	4	3.1	4.01	B3015/32 ⁴⁾
11/64	3.23	89	57	4	3.6	4.42	B30111/64 ⁴⁾
3/16	3.50	102	70	4	4.0	4.95	B3013/16 ⁴⁾
7/32	4.13	102	70	6	4.5	5.59	B3017/32 ⁴⁾
1/4	4.64	117	86	6	5.0	6.43	B3011/4 ⁵⁾
9/32	5.23	143	105	6	5.6	7.42	B3019/32 ⁵⁾
5/16	5.84	143	105	6	6.3	8.03	B3015/16 ⁵⁾
11/32	6.43	152	114	6	7.1	8.81	B30111/32 ⁵⁾
3/8	7.03	165	127	6	8.0	9.68	B3013/8 ⁵⁾
13/32	7.42	191	146	6	8.0	10.46	B30113/32 ⁵⁾
7/16	8.21	191	146	6	9.0	11.25	B3017/16 ⁵⁾
1/2	9.41	210	165	6	10.0	12.85	B3011/2 ⁵⁾

⁴⁾ Limit tolerance +0.0030 / Границы полей допусков +0.0030 / Wymiar graniczny +0.0030 / Limit tolerance +0.0030

⁵⁾ Limit tolerance +0.0050 / Границы полей допусков +0.0050 / Wymiar graniczny +0.0050 / Limit tolerancie +0.0050

B903

- Výstružník ruční na kuželové kolíky
- Коническая ручная развертка
- Rozwiertak ręczny pod kołki
- Výstružník ručný na kuželové kolíky

B903	▪	1.1	1.2	1.3	1.4	2.1	3.1	4.1	6.2										
	•	1.5	1.6	2.2	2.3	3.2	3.3	3.4	4.2	4.3	5.1	6.1	6.3	6.4	7.1	7.2	7.3	7.4	8.2

B903 HSS ST DIN 9    



B903



1.50 - 20.00

nom Ø	d ₁ Ø mm	d ₂ Ø mm	l ₁ mm	l ₂ mm	z	∇ a mm	d ₃ Øh ₁₁ mm	B903
1.5	1.40	2.14	57	37	4	1.80	2.14	B9031.5 ⁶⁾
2.0	1.90	2.86	68	48	4	2.24	2.86	B9032.0 ⁶⁾
2.5	2.40	3.36	68	48	4	2.80	3.36	B9032.5 ⁶⁾
3.0	2.90	4.06	80	58	4	3.15	4.00	B9033.0 ⁶⁾
4.0	3.90	5.26	93	68	4	4.00	5.00	B9034.0 ⁶⁾
5.0	4.90	6.36	100	73	4	5.00	6.30	B9035.0 ⁶⁾
6.0	5.90	8.00	135	105	6	6.30	7.90	B9036.0 ⁷⁾
8.0	7.90	10.80	180	145	6	8.00	10.50	B9038.0 ⁷⁾
10.0	9.90	13.40	215	175	6	10.00	13.30	B90310.0 ⁷⁾
12.0	11.80	16.00	255	210	8	11.20	16.00	B90312.0 ⁷⁾
13.0	12.86	16.74	255	210	8	12.50	16.74	B90313.0 ⁷⁾
14.0	13.86	17.74	255	210	8	12.50	17.74	B90314.0 ⁷⁾
16.0	15.80	20.40	280	230	8	14.00	20.40	B90316.0 ⁷⁾
20.0	19.80	24.80	310	250	8	18.00	24.80	B90320.0 ⁷⁾

⁶⁾ Limit tolerance +0.0750 / Границы полей допусков +0.0750 / Wymiar graniczny +0.0750 / Limit tolerance +0.0750

⁷⁾ Limit tolerance +0.125 / Границы полей допусков +0.0050 / Wymiar graniczny +0.125 / Limit tolerance +0.125

- B952**
- Výstružník ruční na kuželové kolíky
 - Коническая ручная развертка со спиральным зубом
 - Rozwiertak ręczny pod kołki - ze spiralnymi ostrzami
 - Výstružník ručný na kužeľové kolíky

B952 ■ 1.1 1.2 1.3 1.4 2.1 3.1 4.1 6.2
 • 1.5 1.6 2.2 2.3 3.2 3.3 3.4 4.2 4.3 5.1 6.1 6.3 6.4 7.1 7.2 7.3 7.4 8.2

B952 HSS DIN 9 B 1:50

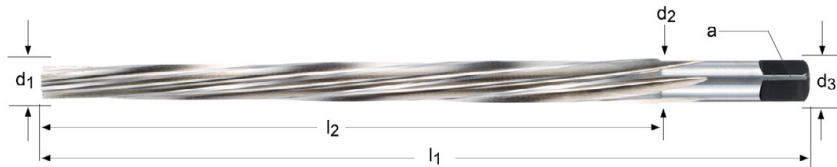

nom Ø	d ₁ Ø mm	d ₂ Ø mm	l ₁ mm	l ₂ mm	z	□ a mm	d ₃ Ø _{h₁₁} mm	B952
1.2	1.1	1.74	50	32	3	2.4	3.15	B9521.2 ⁸⁾
1.5	1.4	2.14	57	37	3	2.4	3.15	B9521.5 ⁸⁾
2.0	1.9	2.86	68	48	3	2.4	3.15	B9522.0 ⁸⁾
2.5	2.4	3.36	68	48	4	2.4	3.15	B9522.5 ⁸⁾
3.0	2.9	4.06	80	58	5	3.0	4.00	B9523.0
3.5	3.4	4.66	87	63	5	3.4	4.50	B9523.5
4.0	3.9	5.26	93	68	5	3.8	5.00	B9524.0
4.5	4.4	5.80	95	70	5	4.3	5.60	B9524.5
5.0	4.9	6.36	100	73	5	4.9	6.30	B9525.0
5.5	5.4	7.20	118	90	6	5.5	7.10	B9525.5
6.0	5.9	8.00	135	105	6	6.2	8.00	B9526.0
6.5	6.4	8.60	140	110	6	6.2	8.00	B9526.5
7.0	6.9	9.40	160	125	6	7.0	9.00	B9527.0
8.0	7.9	10.8	180	145	6	8.0	10.00	B9528.0
9.0	8.9	12.1	195	160	6	9.0	11.20	B9529.0
10.0	9.9	13.4	215	175	6	10.0	12.50	B95210.0
12.0	11.8	16.0	255	210	8	11.0	14.00	B95212.0
13.0	12.8	17.0	255	210	8	12.0	16.00	B95213.0
14.0	13.8	18.0	255	210	8	12.0	16.00	B95214.0
16.0	15.8	20.4	280	230	8	14.5	18.00	B95216.0
20.0	19.8	24.8	310	250	8	18.0	22.40	B95220.0
25.0	24.7	30.7	370	300	10	22.0	28.00	B95225.0
30.0	29.7	36.1	400	320	10	24.0	31.50	B95230.0
40.0	39.7	46.5	430	340	12	32.0	40.00	B95240.0
50.0	49.7	56.9	460	360	12	39.0	50.00	B95250.0

⁸⁾ Příčná drážka, typ A / Прямая стружечная канавка, форма A / z prostym rowkiem, kształt A / Priama drážka, typ A

- B122**
- Výstružník kuželový, levotočivé šroubovitě drážky
 - Кузовная развёртка, спиральная канавка
 - Stożkowy rozwiertak dla przemysłu samochodowego lewo skrętny
 - Výstružník kuželový, ľavotočivá skrutkovica

B122	▪	1.1	1.2	1.3	1.4	2.1	3.1	4.1	6.2										
	•	1.5	1.6	2.2	2.3	3.2	3.3	3.4	4.2	4.3	5.1	6.1	6.3	6.4	7.1	7.2	7.3	7.4	8.2

B122 HSS



ANSI



B122



3/8 - 1.1/16

d_1 Ø Inch	d_1 decimal Inch	l_1 Inch	l_2 Inch	z	d_2 Ø Inch	B122
3/8	0.3750	4.5/8	2.1/2	4	3/8	B1223/8
1/2	0.5000	5.7/8	3.3/4	5	1/2	B1221/2
9/16	0.5625	5.7/8	3.3/4	5	1/2	B1229/16
5/8	0.6250	6.3/8	4.1/4	5	1/2	B1225/8
11/16	0.6875	6.3/8	4.1/4	5	1/2	B12211/16
3/4	0.7500	6.7/8	4.1/2	5	1/2	B1223/4
13/16	0.8125	6.7/8	4.1/2	5	1/2	B12213/16
7/8	0.8750	6.7/8	4.1/2	5	1/2	B1227/8
15/16	0.9375	6.7/8	4.1/2	5	1/2	B12215/16
1"	1.0000	6.7/8	4.1/2	5	1/2	B1221
1.1/16	1.0625	6.7/8	4.1/2	5	1/2	B1221.1/16

B953

- Výstružník strojní pro kuželové kolíky, levotočivá šroubovice 45°
- Машинная коническая развертка с левосторонней спиралью 45°
- Rozwiertak maszynowy pod kołki stożkowe, lewoskrętny rowek wiórowy 45°
- Výstružník strojný pre kužeľové kolíky, ľavotočivá skrutkovica 45°

Hrot dle DIN 1809
 Согласно DIN 1809
 Chwył zgodnie z DIN 1809
 Hrot podľa DIN 1809

B953 ■ 2.1 2.2 2.3 4.1 4.2 4.3 5.1 5.2 5.3 6.1 7.1 7.2 7.3 7.4 8.1
 • 1.1 1.2 1.3 1.4 1.5 1.6 6.2 9.1

B953 HSS-E 1:50

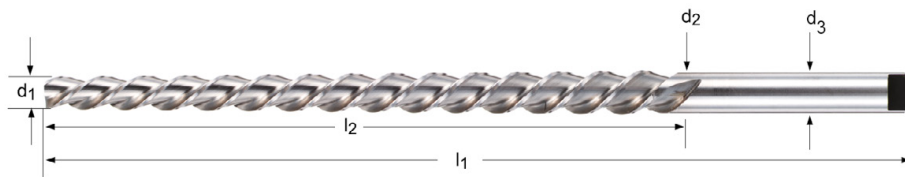

nom Ø	d_1 Ø mm	d_2 Ø mm	l_1 mm	l_2 mm	z	d_3 Ø _{h₃} mm	B953
1.0	0.8	1.46	60	33	2	1.4	B9531.0
1.5	1.4	2.14	70	37	2	2.1	B9531.5
2.0	1.9	2.86	86	48	3	3.15	B9532.0
2.5	2.4	3.36	86	48	3	3.15	B9532.5
3.0	2.9	4.06	100	58	3	4.0	B9533.0
4.0	3.9	5.26	112	68	3	5.0	B9534.0
5.0	4.9	6.36	122	73	3	6.3	B9535.0
6.0	5.9	8.00	160	105	3	8.0	B9536.0
6.5	6.4	8.78	188	119	3	8.5	B9536.5
8.0	7.9	10.80	207	145	3	10.0	B9538.0
10.0	9.9	13.40	245	175	3	12.5	B95310.0
12.0	11.8	16.00	290	210	3	16.0	B95312.0

B180

- NC - výstružník pro vysoce přesné upnutí
- Развертка для станков с ЧПУ
- Rozwiertaki NC do precyzyjnych uchwytów
- NC výstružník pre vysokopresné upnutie

B180	▪	1.1	1.2	1.3	1.4	2.1	4.2	5.1											
	•	1.5	1.6	2.2	2.3	2.4	3.1	3.2	3.3	3.4	4.1	4.3	5.2	5.3	6.1	6.2	6.3	6.4	

B180 HSS-E



DIN
212



DIN
6535HA

B

H7



B180



1.50 - 20.0

d_1 Ø mm	l_1 mm	l_2 mm	l_3 mm	z	d_2 Ø h_6 mm	B180
1.5	40	8	18	3	2	B1801.5
1.6	43	9	20	3	2	B1801.6
1.7	43	9	20	3	2	B1801.7
1.8	46	10	22	4	2	B1801.8
1.9	46	10	22	4	2	B1801.9
2.0	49	11	24	4	2	B1802.0
2.1	49	11	24	4	2	B1802.1
2.2	53	12	26	4	3	B1802.2
2.3	53	12	26	4	3	B1802.3
2.4	57	14	28	4	3	B1802.4
2.5	57	14	28	4	3	B1802.5
2.6	57	14	28	4	3	B1802.6
2.7	61	15	32	6	3	B1802.7
2.8	61	15	32	6	3	B1802.8
2.9	61	15	32	6	3	B1802.9
3.0	61	15	32	6	3	B1803.0
3.1	65	16	35	6	4	B1803.1
3.2	65	16	35	6	4	B1803.2
3.3	65	16	35	6	4	B1803.3
3.4	70	18	40	6	4	B1803.4
3.5	70	18	40	6	4	B1803.5
3.6	70	18	40	6	4	B1803.6
3.7	70	18	40	6	4	B1803.7
3.8	75	19	43	6	4	B1803.8
3.9	75	19	43	6	4	B1803.9
4.0	75	19	43	6	4	B1804.0
4.1	75	19	43	6	4	B1804.1
4.2	75	19	43	6	4	B1804.2
4.3	80	21	47	6	5	B1804.3
4.4	80	21	47	6	5	B1804.4
4.5	80	21	47	6	5	B1804.5
4.6	80	21	47	6	5	B1804.6
4.7	80	21	47	6	5	B1804.7
4.8	86	23	52	6	5	B1804.8
4.9	86	23	52	6	5	B1804.9
5.0	86	23	52	6	5	B1805.0
5.1	86	23	52	6	5	B1805.1
5.2	86	23	52	6	5	B1805.2
5.3	86	23	52	6	5	B1805.3
5.4	93	26	57	6	6	B1805.4

d_1 Ø mm	l_1 mm	l_2 mm	l_3 mm	z	d_2 Ø _{h₆} mm	B180
5.5	93	26	57	6	6	B1805.5
5.6	93	26	57	6	6	B1805.6
5.7	93	26	57	6	6	B1805.7
5.8	93	26	57	6	6	B1805.8
5.9	93	26	57	6	6	B1805.9
6.0	93	26	57	6	6	B1806.0
6.1	101	28	63	6	6	B1806.1
6.2	101	28	63	6	6	B1806.2
6.3	101	28	63	6	6	B1806.3
6.4	101	28	63	6	6	B1806.4
6.5	101	28	63	6	6	B1806.5
6.6	101	28	63	6	6	B1806.6
6.7	101	28	63	6	6	B1806.7
6.8	109	31	69	6	8	B1806.8
6.9	109	31	69	6	8	B1806.9
7.0	109	31	69	6	8	B1807.0
7.1	109	31	69	6	8	B1807.1
7.2	109	31	69	6	8	B1807.2
7.3	109	31	69	6	8	B1807.3
7.4	109	31	69	6	8	B1807.4
7.5	109	31	69	6	8	B1807.5
7.6	117	33	75	6	8	B1807.6
7.7	117	33	75	6	8	B1807.7
7.8	117	33	75	6	8	B1807.8
7.9	117	33	75	6	8	B1807.9
8.0	117	33	75	6	8	B1808.0
8.1	117	33	75	6	8	B1808.1
8.2	117	33	75	6	8	B1808.2
8.3	117	33	75	6	8	B1808.3
8.4	117	33	75	6	8	B1808.4
8.5	117	33	75	6	8	B1808.5
8.6	125	36	81	6	10	B1808.6
8.7	125	36	81	6	10	B1808.7
8.8	125	36	81	6	10	B1808.8
8.9	125	36	81	6	10	B1808.9
9.0	125	36	81	6	10	B1809.0
9.1	125	36	81	6	10	B1809.1
9.2	125	36	81	6	10	B1809.2
9.3	125	36	81	6	10	B1809.3
9.4	125	36	81	6	10	B1809.4
9.5	125	36	81	6	10	B1809.5
9.6	133	38	87	6	10	B1809.6
9.7	133	38	87	6	10	B1809.7
9.8	133	38	87	6	10	B1809.8
9.9	133	38	87	6	10	B1809.9
10.0	133	38	87	6	10	B18010.0
11.0	142	41	96	6	10	B18011.0
12.0	151	44	105	6	10	B18012.0
13.0	151	44	105	6	10	B18013.0
14.0	160	47	110	8	14	B18014.0
15.0	162	50	112	8	14	B18015.0
16.0	170	52	120	8	14	B18016.0
17.0	175	54	123	8	14	B18017.0
18.0	182	56	130	8	14	B18018.0
19.0	189	58	131	8	16	B18019.0
20.0	195	60	137	8	16	B18020.0

- B170**
- Výstružník strojní, setinný
 - Машинная развертка со спиральным зубом
 - Rozwiertak maszynowy
 - Strojny výstružník stotinnový

B170	▪	1.1	1.2	1.3	1.4	2.1	4.2	5.1										
	•	1.5	1.6	2.2	2.3	3.1	3.2	3.3	3.4	4.1	4.3	5.2	5.3	6.1	6.2	6.3	6.4	

B170 HSS-E      



d_1 Ø mm	l_1 mm	l_2 mm	l_3 mm	z	d_2 Ø h_9 mm	B170
0.98	34	5.5	15	3	1.0	B170.98
0.99	34	5.5	15	3	1.0	B170.99
1.00	34	5.5	15	3	1.0	B1701.0
1.01	34	5.5	15	3	1.0	B1701.01
1.02	34	5.5	15	3	1.0	B1701.02
1.03	34	5.5	15	3	1.0	B1701.03
1.04	34	5.5	15	3	1.0	B1701.04
1.05	34	5.5	15	3	1.0	B1701.05
1.49	40	8.0	18	3	1.5	B1701.49
1.50	40	8.0	18	3	1.5	B1701.5
1.51	43	9.0	20	3	1.6	B1701.51
1.52	43	9.0	20	3	1.6	B1701.52
1.98	49	11.0	24	4	2.0	B1701.98
1.99	49	11.0	24	4	2.0	B1701.99
2.00	49	11.0	24	4	2.0	B1702.0
2.01	49	11.0	24	4	2.0	B1702.01
2.02	49	11.0	24	4	2.0	B1702.02
2.03	49	11.0	24	4	2.0	B1702.03
2.04	49	11.0	24	4	2.0	B1702.04
2.05	49	11.0	24	4	2.0	B1702.05
2.49	57	14.0	28	4	2.5	B1702.49
2.50	57	14.0	28	4	2.5	B1702.5
2.51	57	14.0	28	4	2.5	B1702.51
2.52	57	14.0	28	4	2.5	B1702.52
2.98	61	15.0	32	6	3.0	B1702.98
2.99	61	15.0	32	6	3.0	B1702.99
3.00	61	15.0	32	6	3.0	B1703.0
3.01	65	16.0	35	6	3.2	B1703.01
3.02	65	16.0	35	6	3.2	B1703.02
3.03	65	16.0	35	6	3.2	B1703.03
3.04	65	16.0	35	6	3.2	B1703.04
3.05	65	16.0	35	6	3.2	B1703.05
3.49	70	18.0	40	6	3.5	B1703.49
3.50	70	18.0	40	6	3.5	B1703.5
3.51	70	18.0	40	6	3.5	B1703.51
3.52	70	18.0	40	6	3.5	B1703.52
3.98	75	19.0	43	6	4.0	B1703.98
3.99	75	19.0	43	6	4.0	B1703.99
4.00	75	19.0	43	6	4.0	B1704.0
4.01	75	19.0	43	6	4.0	B1704.01

d_1 Ø mm	l_1 mm	l_2 mm	l_3 mm	z	d_2 Ø h_3 mm	B170
4.02	75	19.0	43	6	4.0	B1704.02
4.03	75	19.0	43	6	4.0	B1704.03
4.04	75	19.0	43	6	4.0	B1704.04
4.05	75	19.0	43	6	4.0	B1704.05
4.49	80	21.0	47	6	4.5	B1704.49
4.50	80	21.0	47	6	4.5	B1704.5
4.51	80	21.0	47	6	4.5	B1704.51
4.52	80	21.0	47	6	4.5	B1704.52
4.98	86	23.0	52	6	5.0	B1704.98
4.99	86	23.0	52	6	5.0	B1704.99
5.00	86	23.0	52	6	5.0	B1705.0
5.01	86	23.0	52	6	5.0	B1705.01
5.02	86	23.0	52	6	5.0	B1705.02
5.03	86	23.0	52	6	5.0	B1705.03
5.04	86	23.0	52	6	5.0	B1705.04
5.05	86	23.0	52	6	5.0	B1705.05
5.49	93	26.0	57	6	5.6	B1705.49
5.50	93	26.0	57	6	5.6	B1705.5
5.51	93	26.0	57	6	5.6	B1705.51
5.52	93	26.0	57	6	5.6	B1705.52
5.98	93	26.0	57	6	5.6	B1705.98
5.99	93	26.0	57	6	5.6	B1705.99
6.00	93	26.0	57	6	5.6	B1706.0
6.01	101	28.0	63	6	6.3	B1706.01
6.02	101	28.0	63	6	6.3	B1706.02
6.03	101	28.0	63	6	6.3	B1706.03
6.04	101	28.0	63	6	6.3	B1706.04
6.05	101	28.0	63	6	6.3	B1706.05
6.49	101	28.0	63	6	6.3	B1706.49
6.50	101	28.0	63	6	6.3	B1706.5
6.51	101	28.0	63	6	6.3	B1706.51
6.52	101	28.0	63	6	6.3	B1706.52
6.98	109	31.0	69	6	7.1	B1706.98
6.99	109	31.0	69	6	7.1	B1706.99
7.00	109	31.0	69	6	7.1	B1707.0
7.01	109	31.0	69	6	7.1	B1707.01
7.02	109	31.0	69	6	7.1	B1707.02
7.03	109	31.0	69	6	7.1	B1707.03
7.04	109	31.0	69	6	7.1	B1707.04
7.05	109	31.0	69	6	7.1	B1707.05
7.49	109	31.0	69	6	7.1	B1707.49
7.50	109	31.0	69	6	7.1	B1707.5
7.51	117	33.0	75	6	8.0	B1707.51
7.52	117	33.0	75	6	8.0	B1707.52
7.98	117	33.0	75	6	8.0	B1707.98
7.99	117	33.0	75	6	8.0	B1707.99
8.00	117	33.0	75	6	8.0	B1708.0
8.01	117	33.0	75	6	8.0	B1708.01
8.02	117	33.0	75	6	8.0	B1708.02
8.03	117	33.0	75	6	8.0	B1708.03
8.04	117	33.0	75	6	8.0	B1708.04
8.05	117	33.0	75	6	8.0	B1708.05
8.49	117	33.0	75	6	8.0	B1708.49
8.50	117	33.0	75	6	8.0	B1708.5
8.51	125	36.0	81	6	9.0	B1708.51
8.52	125	36.0	81	6	9.0	B1708.52
8.98	125	36.0	81	6	9.0	B1708.98
8.99	125	36.0	81	6	9.0	B1708.99
9.00	125	36.0	81	6	9.0	B1709.0
9.01	125	36.0	81	6	9.0	B1709.01
9.02	125	36.0	81	6	9.0	B1709.02
9.03	125	36.0	81	6	9.0	B1709.03
9.04	125	36.0	81	6	9.0	B1709.04
9.05	125	36.0	81	6	9.0	B1709.05
9.49	125	36.0	81	6	9.0	B1709.49
9.50	125	36.0	81	6	9.0	B1709.5
9.51	133	38.0	87	6	10.0	B1709.51
9.52	133	38.0	87	6	10.0	B1709.52
9.98	133	38.0	87	6	10.0	B1709.98
9.99	133	38.0	87	6	10.0	B1709.99

d_1 Ø mm	l_1 mm	l_2 mm	l_3 mm	z	d_2 Ø h_9 mm	B170
10.00	133	38.0	87	6	10.0	B17010.0
10.01	133	38.0	87	6	10.0	B17010.01
10.02	133	38.0	87	6	10.0	B17010.02
10.03	133	38.0	87	6	10.0	B17010.03
10.04	133	38.0	87	6	10.0	B17010.04
10.05	133	38.0	87	6	10.0	B17010.05
10.49	133	38.0	87	6	10.0	B17010.49
10.51	133	38.0	87	6	10.0	B17010.51
10.52	133	38.0	87	6	10.0	B17010.52
10.98	142	41.0	96	6	10.0	B17010.98
10.99	142	41.0	96	6	10.0	B17010.99
11.00	142	41.0	96	6	10.0	B17011.0
11.01	142	41.0	96	6	10.0	B17011.01
11.02	142	41.0	96	6	10.0	B17011.02
11.03	142	41.0	96	6	10.0	B17011.03
11.04	142	41.0	96	6	10.0	B17011.04
11.05	142	41.0	96	6	10.0	B17011.05
11.49	142	41.0	96	6	10.0	B17011.49
11.50	142	41.0	96	6	10.0	B17011.5
11.51	142	41.0	96	6	10.0	B17011.51
11.52	142	41.0	96	6	10.0	B17011.52
11.98	151	44.0	105	6	10.0	B17011.98
11.99	151	44.0	105	6	10.0	B17011.99
12.00	151	44.0	105	6	10.0	B17012.0

- B157**
- Výstružník strojní , levotočivá šroubovice 45°
 - Машинная развертка с левосторонней спиралью 45°
 - Rozwiertak maszynowy, lewoskrętny rowek wiórowy 45°
 - Výstružník strojný, ľavotočivá skrutkovica 45°

B157 ■ 1.1 1.2 1.3 1.4 2.1 2.2 2.3 4.1 4.2 4.3 5.1 5.2 5.3 6.1 7.1 7.2 7.3 7.4 8.1
 • 1.5 1.6 6.2 9.1

B157 HSS-E E H7



d ₁ Ø mm	l ₁ mm	l ₂ mm	l ₃ mm	l ₄ mm	z	d ₂ Ø _{h₉} mm	B157
2.0	49	11	3.5	24	3	2.0	B1572.0
3.0	61	15	4.0	32	3	3.0	B1573.0
4.0	75	19	4.0	43	3	4.0	B1574.0
5.0	86	23	4.5	52	3	5.0	B1575.0
6.0	93	26	6.0	57	3	5.6	B1576.0
7.0	109	31	7.0	69	3	7.1	B1577.0
8.0	117	33	9.0	75	3	8.0	B1578.0
9.0	125	36	9.5	81	3	9.0	B1579.0
10.0	133	38	10.0	87	3	10.0	B15710.0
11.0	142	41	10.5	96	3	10.0	B15711.0
12.0	151	44	11.0	105	3	10.0	B15712.0
13.0	151	44	11.5	105	3	10.0	B15713.0
14.0	160	47	12.0	110	3	12.5	B15714.0
15.0	162	50	12.5	112	3	12.5	B15715.0
16.0	170	52	13.0	120	3	12.5	B15716.0
17.0	175	54	13.5	123	3	14.0	B15717.0
18.0	182	56	14.0	130	3	14.0	B15718.0
19.0	189	58	14.5	131	3	16.0	B15719.0
20.0	195	60	15.0	137	3	16.0	B15720.0

- B161**
- Výstružník strojní
 - Машинная развертка
 - Rozwiertak maszynowy
 - Výstružník strojný

B161	▪	1.1	1.2	1.3	1.4	2.1	4.1	5.1											
	•	1.5	1.6	2.2	2.3	3.1	3.2	3.3	3.4	4.2	4.3	5.2	5.3	6.1	6.2	6.3	6.4		

B161 HSS-E   **DIN 208**   **B** **H7** 



B161



3.00 - 50.00

d_1 Ø mm	l_1 mm	l_2 mm	l_3 mm	z	MK	B161
3.0	113	15	47.5	6	1	B1613.0
4.0	124	19	58.5	6	1	B1614.0
5.0	133	23	67.5	6	1	B1615.0
6.0	138	26	72.5	6	1	B1616.0
7.0	150	31	84.5	6	1	B1617.0
8.0	156	33	90.5	6	1	B1618.0
9.0	162	36	96.5	6	1	B1619.0
10.0	168	38	102.5	6	1	B16110.0
11.0	175	41	109.5	6	1	B16111.0
12.0	182	44	116.5	6	1	B16112.0
13.0	182	44	116.5	6	1	B16113.0
14.0	189	47	123.5	8	1	B16114.0
15.0	204	50	124	8	2	B16115.0
16.0	210	52	130	8	2	B16116.0
17.0	214	54	134	8	2	B16117.0
18.0	219	56	139	8	2	B16118.0
19.0	223	58	143	8	2	B16119.0
20.0	228	60	148	8	2	B16120.0
21.0	232	62	152	8	2	B16121.0
22.0	237	64	157	8	2	B16122.0
23.0	241	66	161	8	2	B16123.0
24.0	268	68	169	8	3	B16124.0
25.0	268	68	169	8	3	B16125.0
26.0	273	70	174	8	3	B16126.0
27.0	277	71	178	10	3	B16127.0
28.0	277	71	178	10	3	B16128.0
29.0	281	73	182	10	3	B16129.0
30.0	281	73	182	10	3	B16130.0
31.0	285	75	186	10	3	B16131.0
32.0	317	77	193	10	4	B16132.0
33.0	317	77	193	10	4	B16133.0
34.0	321	78	197	10	4	B16134.0
35.0	321	78	197	10	4	B16135.0
36.0	325	79	201	10	4	B16136.0
38.0	329	81	205	10	4	B16138.0
40.0	329	81	205	10	4	B16140.0
42.0	333	82	209	12	4	B16142.0
44.0	336	83	212	12	4	B16144.0

d₁ ∅ mm	l₁ mm	l₂ mm	l₃ mm	z	MK	B161
45.0	336	83	212	12	4	B16145.0
46.0	340	84	216	12	4	B16146.0
47.0	340	84	216	12	4	B16147.0
48.0	344	86	220	12	4	B16148.0
50.0	344	86	220	12	4	B16150.0

B101

- Výstružník strojní
- Машинная развертка
- Rozwiertak maszynowy
- Výstružník strojný

B101 ■ 1.1 1.2 1.3 1.4 2.1 3.1 4.1 6.2
 • 1.5 1.6 3.2 3.3 3.4 4.2 4.3 5.1 5.2 5.3 6.1 6.3 6.4 7.1 7.2 8.2

B101 HSS-E  ST  BS 328   B  H7

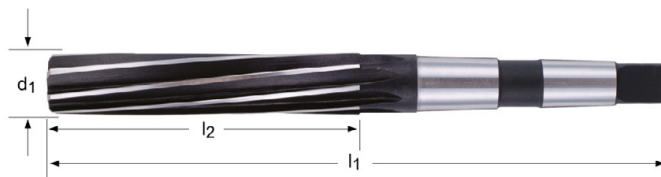

B101



3.00 - 2"

d_1 Ø Inch	d_1 Ø mm	l_1 mm	l_2 mm	z	MK	B101
1/8	3.00	112	33	4	1	B1013.0
	3.18	112	33	4	1	B1011/8
	3.50	115	35	6	1	B1013.5
	4.00	117	38	6	1	B1014.0
	4.50	120	41	6	1	B1014.5
3/16	4.76	124	44	6	1	B1013/16
	5.00	124	44	6	1	B1015.0
	5.50	127	47	6	1	B1015.5
	6.00	127	47	6	1	B1016.0
1/4	6.35	130	50	6	1	B1011/4
	6.50	130	50	6	1	B1016.5
	7.00	134	54	6	1	B1017.0
5/16	7.94	138	58	6	1	B1015/16
	8.00	138	58	6	1	B1018.0
	8.50	138	58	6	1	B1018.5
	9.00	142	62	6	1	B1019.0
	9.50	142	62	6	1	B1019.5
3/8	9.52	146	66	6	1	B1013/8
	10.00	146	66	6	1	B10110.0
	10.50	146	66	6	1	B10110.5
	11.00	151	71	6	1	B10111.0
7/16	11.11	151	71	6	1	B1017/16
	12.00	156	76	6	1	B10112.0
	12.50	156	76	6	1	B10112.5
1/2	12.70	156	76	6	1	B1011/2
	13.00	156	76	6	1	B10113.0
	13.50	161	81	6	1	B10113.5
	14.00	161	81	8	1	B10114.0
9/16	14.29	181	81	8	2	B1019/16
	14.50	181	81	8	2	B10114.5
	15.00	181	81	8	2	B10115.0
	15.50	187	87	8	2	B10115.5
5/8	15.88	187	87	8	2	B1015/8
	16.00	187	87	8	2	B10116.0
	16.50	187	87	8	2	B10116.5
	17.00	187	87	8	2	B10117.0
	18.00	193	93	8	2	B10118.0
	19.00	193	93	8	2	B10119.0
3/4	19.05	200	100	8	2	B1013/4
	20.00	200	100	8	2	B10120.0

d₁ Ø	d₁ Ø	l₁	l₂	z	MK	B101
Inch	mm	mm	mm			
13/16	20.64	200	100	8	2	B10113/16
	21.00	200	100	8	2	B10121.0
	22.00	207	107	8	2	B10122.0
7/8	22.22	207	107	8	2	B1017/8
	23.00	207	107	8	2	B10123.0
	24.00	242	115	8	3	B10124.0
1"	25.00	242	115	10	3	B10125.0
	25.40	242	115	10	3	B1011
	26.00	242	115	10	3	B10126.0
	27.00	251	124	10	3	B10127.0
1.1/8	28.00	251	124	10	3	B10128.0
	28.58	251	124	10	3	B1011.1/8
	29.00	251	124	10	3	B10129.0
	30.00	251	124	10	3	B10130.0
1.1/4	31.00	260	133	10	3	B10131.0
	31.75	260	133	10	3	B1011.1/4
	32.00	293	133	10	4	B10132.0
	34.00	302	142	10	4	B10134.0
1.3/8	34.93	302	142	10	4	B1011.3/8
	35.00	302	142	10	4	B10135.0
	36.00	302	142	10	4	B10136.0
	37.00	302	142	10	4	B10137.0
1.1/2	38.00	312	152	10	4	B10138.0
	38.10	312	152	10	4	B1011.1/2
	39.00	312	152	10	4	B10139.0
	40.00	312	152	10	4	B10140.0
	41.00	312	152	10	4	B10141.0
	42.00	312	152	10	4	B10142.0
	43.00	323	163	10	4	B10143.0
1.3/4	44.00	323	163	10	4	B10144.0
	44.45	323	163	10	4	B1011.3/4
	45.00	323	163	12	4	B10145.0
	46.00	323	163	12	4	B10146.0
	47.00	323	163	12	4	B10147.0
	48.00	334	174	12	4	B10148.0
2"	50.00	334	174	12	4	B10150.0
	50.80	334	174	12	4	B1012

B121

- Výstružník s kuželovým náběhem - šroubovitě drážky
 - Коническая развертка со спиральным зубом и конусом Морзе
 - Rozwiertak do otworów w konstrukcjach stalowych z chwytem Morse'a
 - Výstružník s kuželovým nábehom, skrutkovité drážky
- S náběh. úhlem 1:10 (I3) Konusnosť 1:10
 Konusność 1:10 Zbiežnosť 1:10
 Obsahuje úhol 1:10

B121	▪	1.1	1.2	1.3	1.4	3.1	4.1
	•	1.5	1.6	3.2	3.3	3.4	8.2

B121

HSS



DIN
311



k11

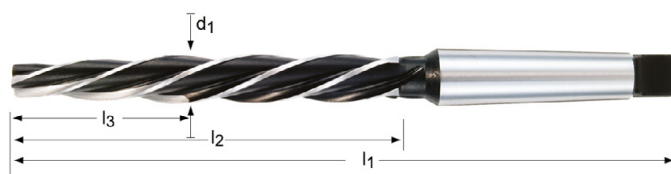

B121



10.00 - 30.00

d_1 Ø mm	l_1 mm	l_2 mm	l_3 mm	z	MK	B121
10.0	171	95	30	4	1	B12110.0
11.0	176	100	33	4	1	B12111.0
12.0	199	105	39	4	2	B12112.0
13.0	199	105	39	4	2	B12113.0
14.0	209	115	42	4	2	B12114.0
15.0	219	125	45	4	2	B12115.0
16.0	229	135	48	4	2	B12116.0
17.0	251	135	51	4	3	B12117.0
18.0	261	145	58	4	3	B12118.0
19.0	261	145	58	4	3	B12119.0
20.0	271	155	62	4	3	B12120.0
21.0	271	155	62	4	3	B12121.0
22.0	281	165	66	4	3	B12122.0
23.0	281	165	66	4	3	B12123.0
24.0	296	180	72	4	3	B12124.0
25.0	296	180	72	4	3	B12125.0
26.0	296	180	72	4	3	B12126.0
30.0	311	195	78	5	3	B12130.0

- B954**
- Výstružník strojní pro kuželové kolíky, levotočivá šroubovice 45°
 - Машинная коническая развертка с левосторонней спиралью 45°
 - Rozwiertak maszynowy pod kołki stożkowe, lewoskrętny rowek wiórowy 45°
 - Výstružník strojný pre kúžeľové kolíky, ľavotočivá skrutkovica 45°

B954	▪	2.1	2.2	2.3	4.1	4.2	4.3	5.1	5.2	5.3	6.1	7.1	7.2	7.3	7.4	8.1
	•	1.1	1.2	1.3	1.4	1.5	1.6	6.2	9.1							

B954 HSS-E

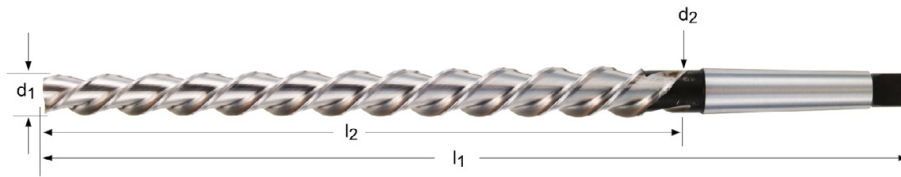

nom Ø	d ₁ Ø mm	d ₂ Ø mm	l ₁ mm	l ₂ mm	z	MK	B954
5.0	4.90	6.36	155	73	3	1	B9545.0
6.0	5.90	8.00	187	105	3	1	B9546.0
8.0	7.90	10.80	227	145	3	1	B9548.0
10.0	9.90	13.40	257	175	3	1	B95410.0
12.0	11.80	16.00	315	210	3	2	B95412.0
13.0	12.86	16.74	295	194	3	2	B95413.0
14.0	13.86	17.74	295	194	3	2	B95414.0
16.0	15.80	20.40	335	230	3	2	B95416.0
20.0	19.80	24.80	377	250	3	3	B95420.0
25.0	24.70	30.70	427	300	3	3	B95425.0
30.0	29.70	36.10	475	320	4	4	B95430.0

- B955**
- Nástrčný výstružník d2=nominální průměr d1 B956
 - Насадная развертка d2=номинальному диаметру d1 развертки B956
 - Rozwiertak nasadzany d2=Średnica nominalna d1 rozwiertaka B956
 - Nástrčný výstružník d2= nominálny priemer d1 od B956

B955	▪	1.1	1.2	1.3	1.4	2.1	4.1	5.1								
	•	1.5	1.6	2.2	2.3	3.1	4.2	4.3	5.2	5.3	6.1	6.2	7.1	7.2	7.3	7.4

B955 HSS-E  ST     

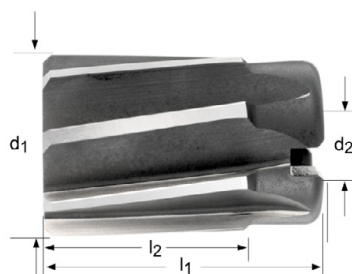

B955



25.00 - 80.00

d_1 Ø mm	l_1 mm	l_2 mm	z	d_2 Ø mm	B955
25.0	45	32	8	13	B95525.0
26.0	45	32	8	13	B95526.0
27.0	45	32	8	13	B95527.0
28.0	45	32	8	13	B95528.0
29.0	45	32	8	13	B95529.0
30.0	45	32	8	13	B95530.0
31.0	50	36	10	16	B95531.0
32.0	50	36	10	16	B95532.0
34.0	50	36	10	16	B95534.0
35.0	50	36	10	16	B95535.0
36.0	56	40	10	19	B95536.0
37.0	56	40	10	19	B95537.0
38.0	56	40	10	19	B95538.0
40.0	56	40	10	19	B95540.0
42.0	56	40	10	19	B95542.0
44.0	63	45	12	22	B95544.0
45.0	63	45	12	22	B95545.0
48.0	63	45	12	22	B95548.0
50.0	63	45	12	22	B95550.0
52.0	71	50	12	27	B95552.0
55.0	71	50	12	27	B95555.0
58.0	71	50	12	27	B95558.0
60.0	71	50	12	27	B95560.0
65.0	80	56	14	32	B95565.0
70.0	80	56	14	32	B95570.0
75.0	90	63	14	40	B95575.0
80.0	90	63	14	40	B95580.0

- B956**
- Trn pro nástrčný výstružník (B955)
 - Оправка для разверток с хвостовиком Морзе (B955)
 - Oprawka pod rozwiertak nasadzany (B955) z chwytem Morse'a
 - Trň pre nástrčný výstružník (B955)

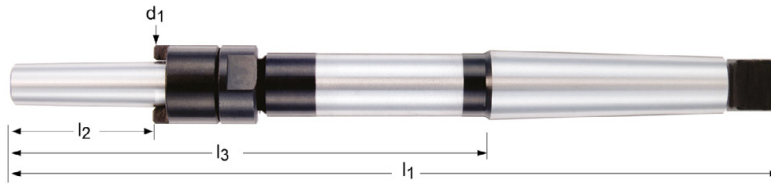

d_1 mm	l_1 mm	l_2 mm	l_3 mm	MK	B956
13.0	250	45	151	3	B95613.0
16.0	261	50	162	3	B95616.0
19.0	298	56	174	4	B95619.0
22.0	312	63	188	4	B95622.0
27.0	359	71	203	5	B95627.0
32.0	376	80	220	5	B95632.0
40.0	396	90	240	5	B95640.0

B957

- Trn pro nástrčný výstružník - náhradní díly (B956)
- Оправка для насадной развертки
- Części zamienne dla (B956)
- Trň pre nástrčný výstružník-náhradné diely (B956)



DRIVER



NUT



WASHER



Nr.	d	B957
3	13.00	B957N3DRIVER
3		B957N3NUT
3		B957N3WASHER
4	16.00	B957N4DRIVER
4		B957N4NUT
4		B957N4WASHER
5	19.00	B957N5DRIVER
5		B957N5NUT
5		B957N5WASHER
6	22.00	B957N6DRIVER
6		B957N6NUT
6		B957N6WASHER
7	27.00	B957N7DRIVER
7		B957N7NUT
7		B957N7WASHER
8	32.00	B957N8DRIVER
8		B957N8NUT
8		B957N8WASHER
9	40.00	B957N9DRIVER
9		B957N9NUT
9		B957N9WASHER

- # G400
- Záhľubník pro vysoce přesné upnutí - 90°
 - Зенковка для высокоточных патронов - 90°
 - Pogłębiacz stożkowy do precyzyjnych uchwytów - 90°
 - Záhľbník pre vysoko presné upnutie - 90°

G400	▪	1.1	1.2	1.3	1.4	1.5	4.1	4.2	4.3	5.1	5.2	5.3	6.1	6.2	6.3	
	•	1.6	2.1	2.2	2.3	3.1	3.2	3.3	3.4	6.4	7.1	7.2	7.3	7.4	8.1	8.2

G400

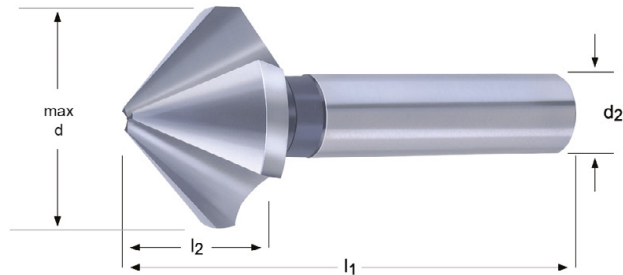

max d mm	min d mm	l ₂ mm	l ₁ mm	d ₂ Øh ₆ mm	z	G400
6.3	1.5	5.0	45	5	3	G4006.3
8.3	2.0	6.0	50	6	3	G4008.3
10.4	2.5	7.1	50	6	3	G40010.4
12.4	2.8	8.0	56	8	3	G40012.4
16.5	3.2	10.0	60	10	3	G40016.5
20.5	3.5	12.5	63	10	3	G40020.5
25.0	3.8	15.0	67	10	3	G40025.0
31.0	4.2	18.0	71	12	3	G40031.0

G135 • Záhľubník - 60°

• Зенковка - 60°

G335 • Pogłębiacz stożkowy - 60°

• Záhľubník - 60°

G135	▪	1.1	1.2	1.3	1.4	1.5	4.1	4.2	4.3	5.1	5.2	5.3	6.1	6.2	6.3
	•	1.6	2.1	2.2	2.3	3.1	3.2	3.3	3.4	6.4	7.1	7.2	7.3	7.4	8.1
G335	▪	1.1	1.2	1.3	3.1	3.2	3.3	3.4	7.1	7.2	7.3	7.4			
	•	1.4	1.5	1.6	4.1	4.2	4.3	5.1	5.2	5.3	6.1	6.2	6.3	6.4	8.1

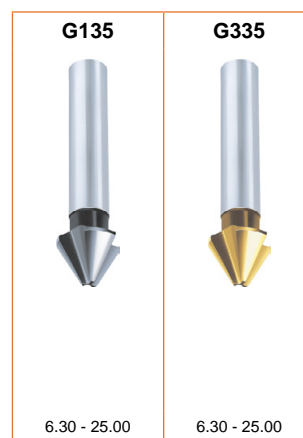
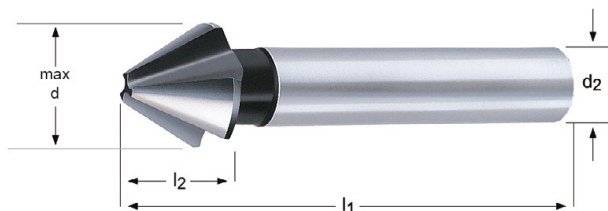

max d mm	min d mm	l ₂ mm	l ₁ mm	d ₂ Øh ₉ mm	z	G135	G335
6.3	1.6	6.8	45	5	3	G1356.3	G3356.3
8.0	2.0	8.5	50	6	3	G1358.0	G3358.0
10.0	2.5	7.6	50	6	3	G13510.0	G33510.0
12.5	3.2	11.7	56	8	3	G13512.5	G33512.5
16.0	4.0	14.5	63	10	3	G13516.0	G33516.0
20.0	5.0	17.5	67	10	3	G13520.0	G33520.0
25.0	6.3	20.5	71	10	3	G13525.0	G33525.0

- G137**
- Záhľubník - 60°
 - Зенковка с хвостовиком Морзе - 60°
 - Pogłębiacz stożkowy z chwytym Morse'a - 60°
 - Záhľbník - 60°

G137	▪	1.1	1.2	1.3	1.4	1.5	4.1	4.2	4.3	5.1	5.2	5.3	6.1	6.2	6.3
		•	1.6	2.1	2.2	2.3	3.1	3.2	3.3	3.4	6.4	7.1	7.2	7.3	7.4

G137

HSS



DIN
334D



60°

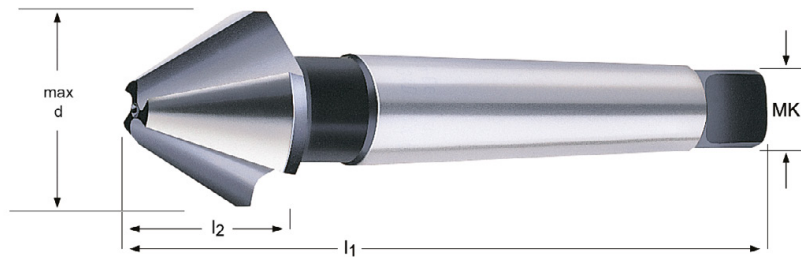

max d mm	min d mm	l ₂ mm	l ₁ mm	MK	z	G137
16.0	4.0	14.5	90	1	3	G13716.0
20.0	5.0	17.5	106	2	3	G13720.0
25.0	6.3	20.0	112	2	3	G13725.0
31.5	10.0	23.0	118	2	3	G13731.5
40.0	12.5	28.5	150	3	3	G13740.0
50.0	16.0	36.0	160	3	3	G13750.0
63.0	20.0	43.0	190	4	3	G13763.0
80.0	25.0	54.0	200	4	3	G13780.0

G154

- Záhľubník - 82°
- Зенковка - 82°
- Pogłębiacz stożkowy - 82°
- Záhľbník - 82°

G154	▪	1.1	1.2	1.3	1.4	1.5	4.1	4.2	4.3	5.1	5.2	5.3	6.1	6.2	6.3	
	•	1.6	2.1	2.2	2.3	3.1	3.2	3.3	3.4	6.4	7.1	7.2	7.3	7.4	8.1	8.2

G154 HSS



DIN
335C



82°

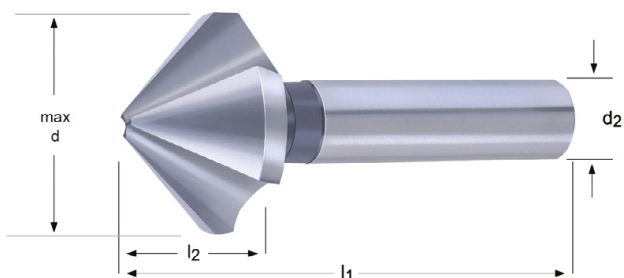

G154



6.30 - 25.00

max d mm	min d mm	l ₂ mm	l ₁ mm	d ₂ Øh ₉ mm	z	G154
6.3	1.5	5.5	45	5	3	G1546.3
8.3	2.0	6.5	50	6	3	G1548.3
10.4	2.5	7.6	50	6	3	G15410.4
12.4	2.8	8.5	56	8	3	G15412.4
16.5	3.2	10.5	60	10	3	G15416.5
20.5	3.5	13.0	63	10	3	G15420.5
25.0	3.8	15.5	67	10	3	G15425.0

- G129**
- Záhľubník - 90°
 - Зенковка- 90°
 - Pogłębiacz stożkowy - 90°
 - Záhľbník - 90°

G129	▪	1.1	1.2	1.3	1.4	4.1	4.2	5.1	5.2	6.1	6.2	6.3	7.1	7.2	
	•	1.1	1.6	2.1	2.2	3.1	3.2	3.3	3.4	4.3	5.3	6.4	7.3	7.4	8.1

G129 HSS 90°

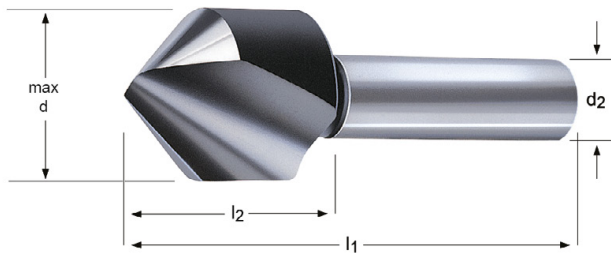

max d mm	l ₂ mm	l ₁ mm	d ₂ Øh ₉ mm	z	G129
6.0	0.0	45	6	1	G1296.0
8.0	0.0	50	8	1	G1298.0
10.0	17.0	49	8	1	G12910.0
12.5	17.0	49	8	1	G12912.5
16.0	20.0	56	10	1	G12916.0
20.0	24.0	60	10	1	G12920.0
25.0	25.0	75	12	1	G12925.0
31.5	29.0	80	12	1	G12931.5

G149

- Záhľubník - 90°
- Зенковка- 90°
- Poglębiacz stożkowy - 90°
- Záhľbník - 90°

G149	▪	1.1	1.2	1.3	1.4	4.1	4.2	5.1	5.2	6.1	6.2	6.3	7.1	7.2	
	•	1.5	1.6	2.1	2.2	3.1	3.2	3.3	3.4	4.3	5.3	6.4	7.3	7.4	8.1

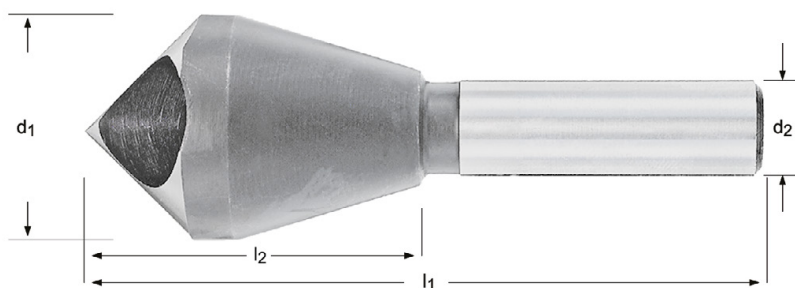

max d mm	min d mm	l ₂ mm	l ₁ mm	d ₂ Ø mm	d ₁ Ø mm	z	G149
5	2	19.0	45	6	10	1	G1495
10	5	23.0	48	8	14	1	G14910
15	10	34.0	65	10	21	1	G14915
20	15	43.0	84	12	28	1	G14920
25	20	48.0	102	15	35	1	G14925
30	25	61.0	115	15	44	1	G14930
35	30	65.0	127	15	48	1	G14935
40	35	66.0	136	15	53	1	G14940
50	40	85.0	166	20	60	1	G14950

- G136** • Záhľubník - 90°
• Зенковка- 90°
- G560** • Pogłębiacz stożkowy - 90°
• Záhľubník - 90°

- G106** • Záhľubník s tříhrannou stopkou
• Зенковка 90 градусов с хвостовиком под трёхкулачковый патрон
- G506** • Pogłębiacz z potrójnie płaskim chwytem - 90°
• Záhľubník 90° s trojhrannou stopkou

G136	▪	1.1	1.2	1.3	1.4	4.1	4.2	5.1	5.2	6.1	6.2	6.3	7.1	7.2	8.1	
	•	1.5	1.6	2.1	2.2	2.3	3.1	3.2	3.3	3.4	4.3	5.3	6.4	7.3	7.4	8.2
G560	▪	1.1	1.2	1.3	1.4	1.5	2.1	3.1	3.2	3.3	3.4	5.1	5.2	5.3	7.3	7.4
	•	1.6	2.2	2.3	4.1	4.2	4.3	6.1	6.2	6.3	6.4	7.1	7.2	8.1	8.2	
G106	▪	1.1	1.2	1.3	1.4	1.5	4.1	4.2	4.3	5.1	5.2	5.3	6.1	6.2	6.3	
	•	1.6	2.1	2.2	2.3	3.1	3.2	3.3	3.4	6.4	7.1	7.2	7.3	7.4	8.1	8.2
G506	▪	1.1	1.2	1.3	3.1	3.2	3.3	3.4	7.1	7.2	7.3	7.4				
	•	1.4	1.5	1.6	4.1	4.2	4.3	5.1	5.2	5.3	6.1	6.2	6.3	6.4	8.1	8.2

G136	HSS		DIN 335C				90°		G236 194
G560	HSS	TiAIN	DIN 335C				90°		G236 194
G106	HSS		DIN 335C				90°		G236 194
G506	HSS	TiAIN	DIN 335C				90°		G236 194

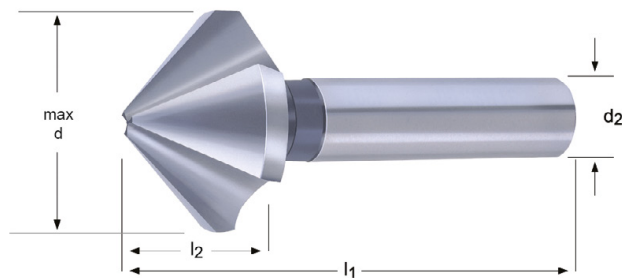

max d mm	min d mm	l ₂ mm	l ₁ mm	d ₂ Øh ₉ mm	z	G136	G560	G106	G506
4.3	1.3	4.0	40	4	3	G1364.3			
5.0	1.5	4.5	40	4	3	G1365.0			
5.3	1.5	4.5	40	4	3	G1365.3			
5.8	1.5	5.0	45	5	3	G1365.8			
6.0	1.5	5.0	45	5	3	G1366.0			
6.3	1.5	5.5	45	5	3	G1366.3	G5606.3		
6.3	1.5	5.6	45	5	3			G1066.3	G5066.3
7.0	1.8	5.5	50	6	3	G1367.0			
7.3	1.8	6.1	50	6	3	G1367.3			
8.0	2.0	6.1	50	6	3	G1368.0	G5608.0		
8.3	2.0	6.5	50	6	3	G1368.3	G5608.3		

max d mm	min d mm	l ₂ mm	l ₁ mm	d ₂ Øh ₃ mm	z	G136	G560	G106	G506
8.3	2.0	6.9	50	6	3			G1068.3	G5068.3
9.4	2.2	7.2	50	6	3	G1369.4			
10.0	2.5	7.6	50	6	3	G13610.0	G56010.0		
10.4	2.5	7.6	50	6	3	G13610.4	G56010.4		
10.4	2.5	7.8	50	6	3			G10610.4	G50610.4
11.5	2.8	8.0	56	8	3	G13611.5			
12.4	2.8	8.5	56	8	3	G13612.4	G56012.4		
12.4	2.8	8.6	56	8	3			G10612.4	G50612.4
13.4	2.9	9.0	56	8	3	G13613.4			
15.0	3.2	9.5	60	10	3	G13615.0			
16.5	3.2	10.5	60	10	3	G13616.5	G56016.5		
16.5	3.2	11.1	60	10	3			G10616.5	G50616.5
19.0	3.5	11.7	63	10	3	G13619.0			
20.5	3.5	13.0	63	10	3	G13620.5	G56020.5		
20.5	3.5	12.9	63	10	3			G10620.5	G50620.5
23.0	3.8	13.7	67	10	3	G13623.0			
25.0	3.8	15.5	67	10	3	G13625.0	G56025.0		
25.0	3.8	15.7	67	10	3			G10625.0	G50625.0
26.0	3.8	15.5	67	10	3	G13626.0			
28.0	4.0	16.5	71	12	3	G13628.0			
30.0	4.2	18.5	71	12	3	G13630.0			
31.0	4.2	18.5	71	12	3	G13631.0	G56031.0	G10631.0	G50631.0
34.0	4.5	19.0	103	16	3			G10634.0	G50634.0
37.0	4.5	21.2	118	16	3			G10637.0	G50637.0
40.0	4.5	20.0	118	16	3			G10640.0	G50640.0
50.0	5.0	23.6	126	16	3			G10650.0	G50650.0

- G142**
- Záhľubník s extra radiálnim podbrusem - 90°
 - Зенковка со специальным радиусом - 90°
 - Poglębiacz stożkowy z dodatkowym promieniowym kątem przyłożenia - 90°
 - Záhľbník s extra radiálnym podbrusom - 90°

- G570**
- Záhľubník - 90°
 - Зенковка - 90°
 - Poglębiacz stożkowy - 90°
 - Záhľbník - 90°

G142	▪	1.1	1.2	2.1	2.2	2.3	4.1	5.1	6.1	6.2	7.1	7.2	8.1	8.2						
	•	1.3	1.4	4.2	5.2	6.3	7.3	7.4												
G570	▪	1.4	1.5	2.1	2.2	2.3														
	•	1.1	1.2	1.3	1.6	2.4	3.1	3.2	3.3	3.4	5.2	5.3	6.1	6.2	6.3	6.4	7.1	7.2	7.3	7.4

G142 HSS

G570 HSS-E

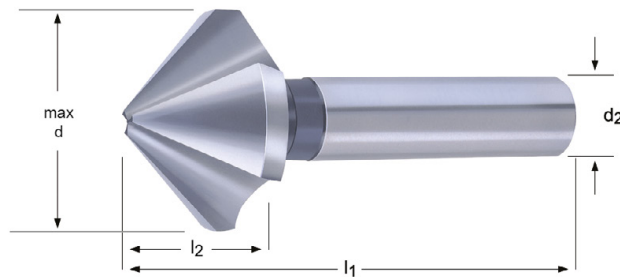

max d mm	min d mm	l ₂ mm	l ₁ mm	d ₂ Øh ₉ mm	z	G142	G570
4.8	1.3	4.5	40	4	3	G1424.8	
5.0	1.5	4.5	40	4	3	G1425.0	
6.0	1.5	5.0	45	5	3	G1426.0	
6.3	1.5	5.5	45	5	3	G1426.3	
6.3	1.5	6.5	45	5	3		G5706.3
7.0	1.8	5.5	50	6	3	G1427.0	
7.3	1.8	6.1	50	6	3	G1427.3	
8.0	2.0	6.1	50	6	3	G1428.0	
8.3	2.0	6.5	50	6	3	G1428.3	
8.3	2.0	8.2	50	6	3		G5708.3
10.0	2.5	7.6	50	6	3	G14210.0	
10.4	2.5	7.6	50	6	3	G14210.4	
10.4	2.5	9.7	50	6	3		G57010.4
11.5	2.8	8.0	56	8	3	G14211.5	
12.4	2.8	8.5	56	8	3	G14212.4	
12.4	2.8	10.6	56	8	3		G57012.4
15.0	3.2	9.5	60	10	3	G14215.0	
16.5	3.2	10.5	60	10	3	G14216.5	
16.5	3.2	13.9	60	10	3		G57016.5
19.0	3.5	11.7	63	10	3	G14219.0	
20.5	3.5	13.0	63	10	3	G14220.5	
20.5	3.5	17.1	63	10	3		G57020.5
23.0	3.8	13.7	67	10	3	G14223.0	
25.0	3.8	15.5	67	10	3	G14225.0	
25.0	3.8	21.4	67	10	3		G57025.0
31.0	4.2	18.5	71	12	3	G14231.0	
31.0	4.2	24.4	71	12	3		G57031.0

- G107**
- Záhľubník se šestihrannou stopkou
 - Зенковка 90 градусов с шестигранным хвостовиком
 - Pogłębiacz z sześciokątnym chwytem - 90°
 - Záhľbník 90° so šest'hrannou stopkou

G107	▪	1.1	1.2	1.3	1.4	1.5	4.1	4.2	4.3	5.1	5.2	5.3	6.1	6.2	6.3
	•	1.6	2.1	2.2	2.3	3.1	3.2	3.3	3.4	6.4	7.1	7.2	7.3	7.4	8.1



G107



6.30 - 20.50

max d mm	min d mm	l ₁ mm	d ₂ Ø A/F mm	DIN 74	z	G107
6.3	1.5	50	1/4"	M2-M3	3	G1076.3
8.3	2.0	50	1/4"	M4	3	G1078.3
10.4	2.5	50	1/4"	M5	3	G10710.4
12.4	2.8	50	1/4"	M6	3	G10712.4
16.5	3.2	50	1/4"	M8	3	G10716.5
20.5	3.5	50	1/4"	M10	3	G10720.5

- G600**
- Zábřubník, extra dlouhý - 90°
 - Зенковка, сверхдлинная - 90°
 - Pogłębiacz stożkowy, bardzo długi - 90°
 - Zábřubník extra dlhý - 90°

G600	▪	1.1	1.2	1.3	1.4	1.5									
		•	1.6	2.1	2.2	2.3	3.1	3.2	3.3	6.1	6.2	6.3	6.4	7.1	7.2

G600

HSS

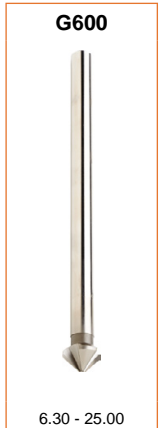
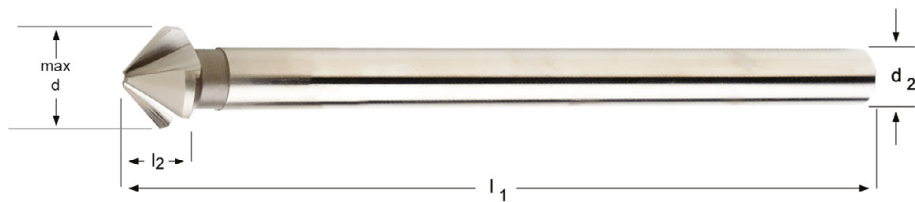

max d mm	min d mm	l ₂ mm	l ₁ mm	d ₂ Øh ₉ mm	z	G600
6.3	1.3	5.6	154	5	3	G6006.3
8.3	1.8	6.9	155	6	3	G6008.3
10.4	2.2	7.8	157	6	3	G60010.4
12.4	2.5	8.6	158	8	3	G60012.4
15.0	2.8	10.3	159	10	3	G60015.0
16.5	2.8	11.1	161	10	3	G60016.5
20.5	3.0	12.9	164	10	3	G60020.5
25.0	3.2	15.7	168	10	3	G60025.0

G132

- Záhľubník - 90°
- Зенковка- 90°
- Pogłębiacz stożkowy - 90°
- Záhľbník - 90°

G132	▪	1.5	1.6	3.4	4.2	4.3	5.2	5.3	6.4
	•	1.3	1.4	2.3	8.3				

G132

HSS



DIN
335A



90°

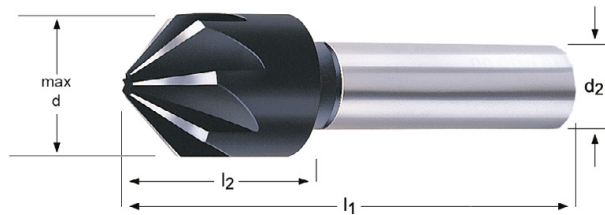

G132



8.00 - 20.00

max d mm	min d mm	l ₂ mm	l ₁ mm	d ₂ Øh ₉ mm	z	G132
8.0	-	0.0	48	8	5	G1328.0
12.5	2.0	15.5	48	8	5	G13212.5
16.0	3.2	19.5	56	10	7	G13216.0
20.0	5.0	23.0	60	10	7	G13220.0

- G138** • Záhľubník - 90°
 • Зенковка с хвостовиком Морзе - 90°
- G338** • Pogłębiacz stożkowy chwytem Morse'a - 90°
 • Záhľubník - 90°

G138	▪	1.1	1.2	1.3	1.4	1.5	4.1	4.2	4.3	5.1	5.2	5.3	6.1	6.2	6.3
	•	1.6	2.1	2.2	2.3	3.1	3.2	3.3	3.4	6.4	7.1	7.2	7.3	7.4	8.1
G338	▪	1.1	1.2	1.3	1.4	1.5	3.1	3.2	3.3	3.4	7.1	7.2	7.3	7.4	
	•	1.6	4.1	4.2	4.3	5.1	5.2	5.3	6.1	6.2	6.3	6.4	8.1	8.2	

G138 HSS

G338 HSS

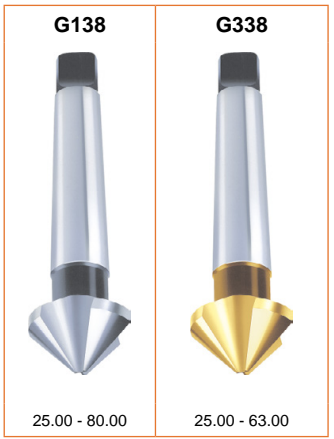
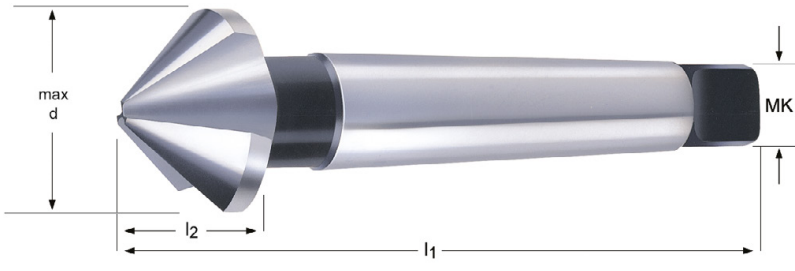

max d mm	min d mm	l ₂ mm	l ₁ mm	MK	z	G138	G338
25.0	3.8	15.5	106	2	3	G13825.0	G33825.0
30.0	4.2	18.5	112	2	3	G13830.0	
31.0	4.2	20.0	112	2	3	G13831.0	G33831.0
34.0	4.5	19.5	118	2	3	G13834.0	
37.0	4.8	21.7	118	2	3	G13837.0	G33837.0
40.0	10.0	20.5	140	3	3	G13840.0	G33840.0
50.0	14.0	24.1	150	3	3	G13850.0	G33850.0
63.0	16.0	28.5	180	4	3	G13863.0	G33863.0
80.0	22.0	36.0	190	4	3	G13880.0	

G171

- Záhľubník - 100°
- Зенковка - 100°
- Pogłębiacz stożkowy - 100°
- Záhľbník - 100°

G171	▪	1.1	1.2	1.3	3.1	3.2	3.3	3.4	7.1	7.2	7.3	7.4				
	•	1.4	1.5	1.6	4.1	4.2	4.3	5.1	5.2	5.3	6.1	6.2	6.3	6.4	8.1	8.2

G171

HSS

TAIN

DIN 335C

100°

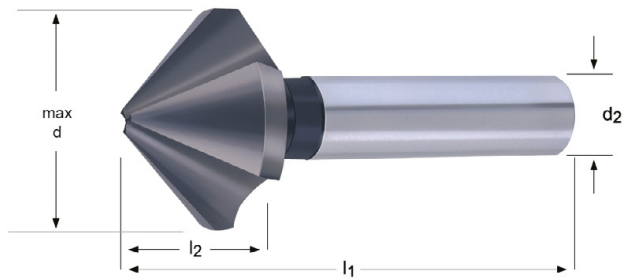

max d mm	min d mm	l ₂ mm	l ₁ mm	d ₂ Øh ₉ mm	z	G171
6.3	1.5	4.5	44	5	3	G1716.3
8.3	2.0	5.5	49	6	3	G1718.3
10.4	2.5	6.6	49	6	3	G17110.4
12.4	2.8	7.0	53	8	3	G17112.4
16.5	3.2	9.0	56	10	3	G17116.5
20.5	3.5	11.0	61	10	3	G17120.5
25.0	3.8	13.5	65	10	3	G17125.0

G314

- Kuželové záhlubníky
- Конические ступенчатые сверла для листового металла
- Wiertło stopniowe do blach
- Kuželový záhlbník

G314	▪	1.1	1.2	1.3	1.4	4.1	4.2	4.3	5.1	5.2	5.3	6.1	6.2	6.3	7.1	7.2	8.1	8.2	
	•	1.5	1.6	2.1	2.2	2.3	3.1	3.2	3.3	3.4	6.4	7.3	7.4						

G314 HSS 20°

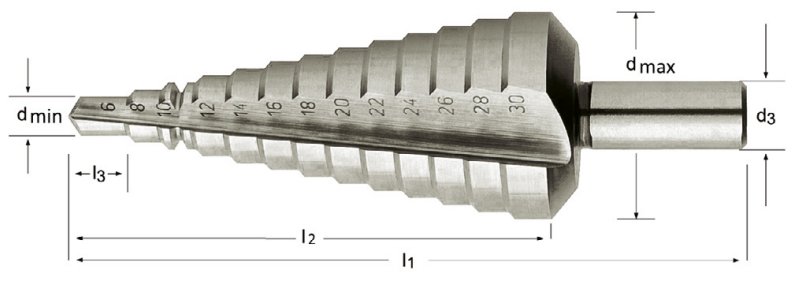

Nr.	d min-max mm	l ₃ mm	l ₂ mm	l ₁ mm	d ₃ ∅ mm	G314
412	4.0 mm ÷ 12.0 mm x 1.0 mm	5.0	61	80	6.0	G314412
1220	12.0 mm ÷ 20.0 mm x 1.0 mm	4.0	55	76	9.0	G3141220
2030	20.0 mm ÷ 30.0 mm x 1.0 mm	4.0	67	88	12.0	G3142030
3040	30.0 mm ÷ 40.0 mm x 1.0 mm	4.0	74	98	13.0	G3143040
420	4.0 mm ÷ 20.0 mm x 2.0 mm	4.0	48	76	8.0	G314420
630	6.0 mm ÷ 30.0 mm x 2.0 mm	4.0	73	98	10.0	G314630
M	9.0 mm ÷ 36.0 mm x 3.0 mm	3.0	57	86	12.0	G314M

- MTS Záhlubník
- Цековка с направляющей - 180°
- Poglębiacz z prowadzeniem - 180°
- MTS záhlbník

G125	▪	1.1	1.2	1.3	2.1	3.1	3.2	7.1	7.2	8.1									
	•	1.4	1.5	1.6	2.2	3.3	3.4	4.1	4.2	4.3	5.1	5.2	5.3	6.1	6.2	6.3	7.3	7.4	8.2

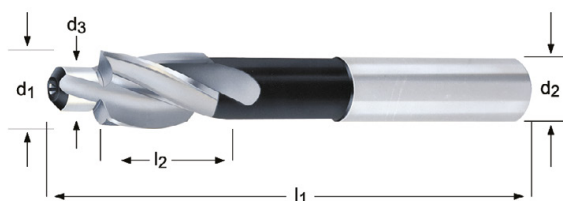

G125



6.50 - 20.00

d_1 $\varnothing z_3$ mm	d_3 $\varnothing e_8$ mm	M	l_1 mm	l_2 mm	d_2 $\varnothing h_9$ mm	z	G125
6.5	2.5	M 3 t	71	14	5.0	3	G1256.5X2.5 ¹⁾
6.5	3.2	M 3 f	71	14	5.0	3	G1256.5X3.2 ²⁾
6.5	3.4	M 3 m	71	14	5.0	3	G1256.5X3.4 ³⁾
8.0	3.3	M 4 t	71	14	5.0	3	G1258.0X3.3 ¹⁾
8.0	4.3	M 4 f	71	14	5.0	3	G1258.0X4.3 ²⁾
8.0	4.5	M 4 m	71	14	5.0	3	G1258.0X4.5 ³⁾
10.0	4.2	M 5 t	80	18	8.0	3	G12510.0X4.2 ¹⁾
10.0	5.3	M 5 f	80	18	8.0	3	G12510.0X5.3 ²⁾
10.0	5.5	M 5 m	80	18	8.0	3	G12510.0X5.5 ³⁾
11.0	5.0	M 6 t	80	18	8.0	3	G12511.0X5.0 ¹⁾
11.0	6.4	M 6 f	80	18	8.0	3	G12511.0X6.4 ²⁾
11.0	6.6	M 6 m	80	18	8.0	3	G12511.0X6.6 ³⁾
15.0	6.8	M 8 t	100	22	12.5	3	G12515.0X6.8 ¹⁾
15.0	8.4	M 8 f	100	22	12.5	3	G12515.0X8.4 ²⁾
15.0	9.0	M 8 m	100	22	12.5	3	G12515.0X9.0 ³⁾
18.0	8.5	M 10 t	100	22	12.5	3	G12518.0X8.5 ¹⁾
18.0	10.5	M 10 f	100	22	12.5	3	G12518.0X10.5 ²⁾
18.0	11.0	M 10 m	100	22	12.5	3	G12518.0X11.0 ³⁾
20.0	10.2	M 12 t	100	22	12.5	3	G12520.0X10.2 ¹⁾
20.0	13.0	M 12 f	100	22	12.5	3	G12520.0X13.0 ²⁾
20.0	13.5	M 12 m	100	22	12.5	3	G12520.0X13.5 ³⁾

¹⁾ t = díra pro závit / t = для отверстия под резьбу / t = otwór pod gwintownik / t = diera pre závit

²⁾ f = pro průchozí díry, jemné / f = для сквозного отверстия (точный) / f = do otworów przelotowych / f = pre priechodzie diery, jemné

³⁾ m = pro průchozí díry, střední / m = для сквозного отверстия (средний) / m = dla otworów przelotowych średnich / m = pre priechodzie diery, středné

G236

- Sada záhlubníků
- Набор зенковок
- Zestaw pogłębiaczy stożkowych
- Sada záhlbníkov

A=typy v sadě, B=počet v sadě, C=rozměry v sadě

A=тип зенковок в наборе, B=кол-во зенковок, C=диаметры в наборе

A=Typy w komplecie. B=Ilość w komplecie. C=Średnice występujące w komplecie

A=typy v sade, B=počet v sade, C=rozmery v sade



Set

Nr.	A	B	C	G236
1	G136	6	6.30 mm, 8.30 mm, 10.40 mm, 12.40 mm, 16.50 mm, 20.50 mm	G2361
2	G136	4	6.30 mm, 10.40 mm, 16.50 mm, 20.50 mm	G2362
3	G560	6	6.30 mm, 8.30 mm, 10.40 mm, 12.40 mm, 16.50 mm, 20.50 mm	G2363
4	G106	6	6.30 mm, 8.30 mm, 10.40 mm, 12.40 mm, 16.50 mm, 20.50 mm	G2364
5	G506	6	6.30 mm, 8.30 mm, 10.40 mm, 12.40 mm, 16.50 mm, 20.50 mm	G2365

201 - 212



J200	205
J205	205
J210	206
J215	206
J220	207
J225	207
J235	208
J245	209
J260	211
J280	210

Typ závitu	Тип резьбы	Typ Gwintu	Typ závitu
Standard	Стандарт	Standard	Štandard
Hĺoubka	Глубина	Głębokość	Hĺbka
Materiál	Материал	Materiał	Materiál
Úhel šroubovice	Угол спирали	Kąt spirali	Uhol skrutkovice
Směr otáčení	Направление	Kierunek	Smer
Povlak	Покрытие	Pokrycie	Povlak
Stopka	Хвостовик	Chwyt	Stopka
Chlazení	СОЖ	Chłodziwo	Chladienie
<ul style="list-style-type: none"> ■ vynikající ● dobrý Příklad 10 = řezná rychlost (m/min) +/- 10%	Основное применение Возможное применение Пример: 10 = Скорость резания в м/мин +/- 10%	Najlepsze zastosowanie Dobre zastosowanie Na przykład 10 = prędkość skrawania w m/min +/- 10%	Vynikajúce Dobré Příklad 10 = rezná rýchlosť (m/min) +/- 10%
Kód	Код	Kod	Kód
Rozměrová řada	Ассортимент	Zakres	Rozsah rozmerov

AMG	Česky	Русский	Polski	Slovensky
1.1	magneticky měkká	Автоматная сталь	magnetyczna miękka	Magneticky mäkká oceľ
1.2	konstrukční uhlíkatá	Низкоуглеродистая сталь	konstrukcyjna do nawęglania	Konstruktúrna oceľ,uhlíková
1.3	uhlíkatá	Углеродистая нелегированная сталь	węglowa	Uhlíková oceľ
1.4	legovaná	Легированная сталь	stopowa	Legovaná oceľ
1.5	legovaná, tvrzená a temperovaná	Легированная сталь после отжига	stopowa-hartowana i odpuszczana	Legovaná oceľ, tvrdená a temperovaná
1.6	legovaná, tvrzená a temperovaná	Высоколегированная сталь после отжига	stopowa-hartowana i odpuszczana	Legovaná oceľ, tvrdená a temperovaná
1.7	legovaná, tvrzená	Легированная закаленная сталь	stopowa-hartowana	Legovaná oceľ tvrdená
1.8	legovaná, tvrzená	Легированная закаленная сталь	stopowa-hartowana	Legovaná oceľ tvrdená, oceľ odolná oproti opotrebovaniu
2.1	automatová	Ферритная нержавеющая сталь	automatowa	Automatová nehrdzavejúca oceľ
2.2	austenitická	Аустенитная нержавеющая сталь	austenityczna	Austenická
2.3	fertická+austenitická	Ферритно-аустенитная нержавеющая сталь	ferrytyczna+austenityczna	Feriticko austenitická nehr. oceľ (Duplex)
2.4	precipitačně tvrzená	Сталь дисперсионного твердения	Utwardzane wydzieleniowo	Tvrdená nehr. oceľ
3.1	lamelární	Серый чугун	szare	Sivá liatina
3.2	lamelární	Ковкий чугун	szare	Sivá liatina
3.3	nodulární	Высокопрочный чугун	sferoidalne ciągliwe	Tvárna liatina
3.4	nodulární	Высокопрочный чугун	sferoidalne ciągliwe	Tvárna liatina
4.1	čistý	Технически чистый титан	niestopowy	Čistý titán
4.2	slitiny	Титановые сплавы	stopy tytanu	Zliatiny titánu
4.3	slitiny	Титановые сплавы	stopy tytanu	Zliatiny titánu
5.1	čistý	Технически чистый никель	niestopowy	Čistý nikel
5.2	slitiny	Никелевые сплавы	stopy niklu	Zliatiny niklu
5.3	slitiny	Никелевые сплавы	stopy niklu	Zliatiny niklu
6.1	bronz	Технически чистая медь	niestopowa	Bronz
6.2	β - mosaz, bronz	Бронза	Mosiądz-β,brąz	β - mosadz, bronz
6.3	bronz mosaz	Латунь	Mosiądz CuZn	Mosadz, bronz
6.4	bronz vysokopevnostní	Высокопрочная бронза	Brąz o wysokiej wytrzymałości	Vysokopevnostný bronz
7.1	Al, Mg, tvářené	Технически чистый алюминий/магний	Al.,Mg, niestopowe	Al, Mg, tvárnený (čistý)
7.2	Al slitiny, Si<0.5%	Сплавы Al с содержанием Si<0.5%	Al. Stopowe,Si<0,5%	Al zliatiny, Si<0,5%
7.3	Al slitiny, Si>0.5%<10%	Сплавы Al с содержанием 0.5%<Si<10%	Al. Stopowe,Si>0,5%<10%	Al zliatiny, Si>0,5%<10%
7.4	Al slitiny, Si>10%	Сплавы Al с содержанием Si>10%	Al. Stopowe,Si>10%	Al zliatiny, Si>10%
8.1	termoplasty	Термопластики	Tworzywa termoplastyczne	Termoplasty
8.2	termosety	Термореактивные полимеры	Tworzywa termoutwardzalne	Termosety
8.3	zpevněné plasty	Армированные полимеры	Zbrojone tworzywa sztuczne	Spevnené plasty
9.1	cermet (keramika)	Металлокерамика	Cermetale	Cermet (kov-keramika)
10.1	standardní grafit	Технический графит	Grafit standartowy	Grafit

M	M	M	M	MF	MF	UNC	UNF	G	NPT
2XD	2XD	2XD	2XD	1.5XD	1.5XD	2XD	2XD	1.5XD	
HM	HM	HM	HM	HM	HM	HM	HM	HM	HM
DIN 6535HA	DIN 6535HB	DIN 6535HA	DIN 6535HA	DIN 6535HA	DIN 6535HB	DIN 6535HB	DIN 6535HB	DIN 6535HA	DIN 6535HB
J200	J205	J210	J215	J220	J225	J235	J245	J280	J260
M4 - M16	M8 - M16	M6 - M16	M6 - M16	M6 - M24	M10 - M18	1/4 - 3/4	1/4 - 3/4	1/8 - 3"	1/8 - 2"

AMG	205	205	206	206	207	207	208	209	210	211	ISO
1.1	■170B	■170B	■175B	■175B	■170B	■170B	■170B	■170B	■170B	■170B	P 1
1.2	■170B	■170B	■175B	■175B	■170B	■170B	■170B	■170B	■170B	■170B	P 1
1.3	■140B	■140B	■145B	■145B	■140B	■140B	■140B	■140B	■140B	■140B	P 2
1.4	■130B	■130B	■135B	■135B	■130B	■130B	■130B	■130B	■130B	■130B	P 3
1.5	■100B	■100B	■105B	■105B	■100B	■100B	■100B	■100B	■100B	■100B	P 4
1.6	■80B	■80B	■85B	■85B	■80B	■80B	■80B	■80B	■80B	■80B	H 1
1.7	●50A	●50A	●50A	●50A	●50A	●50A	●50A	●50A	●50A	●50A	H 3
1.8	●30A	●30A	●30A	●30A	●30A	●30A	●30A	●30A	●30A	●30A	H 4
2.1	●50A	●50A	●50A	●50A	●50A	■50A	■50A	■50A	●50A	●50A	M 1
2.2	●40A	●40A	●40A	●40A	●40A	■40A	■40A	■40A	●40A	●40A	M 3
2.3	●30A	■30A	●30A	●30A	●30A	■30A	■30A	■30A	●30A	●30A	M 2
2.4	●25A	■25A	●25A	●25A	●25A	■25A	■25A	■25A	●25A	●25A	S 2
3.1	■150B	■150B	■155B	■155B	■150B	■150B	■150B	■150B	■150B	■150B	K 1
3.2	■130B	■130B	■135B	■135B	■130B	■130B	■130B	■130B	■130B	■130B	K 2
3.3	■150B	■150B	■155B	■155B	■150B	■150B	■150B	■150B	■150B	■150B	K 3
3.4	■120B	■120B	■125B	■125B	■120B	■120B	■120B	■120B	■120B	■120B	K 4
4.1	■170B	■170B	■175B	■175B	■170B	■170B	■170B	■170B	■170B	■170B	S 1
4.2	■80B	■80B	■80B	■80B	■80B	■80B	■80B	■80B	■80B	■80B	S 2
4.3	■50B	■50B	■50B	■50B	■50B	■50B	■50B	■50B	■50B	■50B	S 3
5.1	●250B	■250B	●250B	●255B	●250B	■250B	■250B	■250B	●250B	■250B	S 1
5.2	●40A	■40A	●40A	●40A	●40A	■40A	■40A	■40A	●40A	●40A	S 2
5.3	●25A	■25A	●25A	●25A	●25A	■25A	■25A	■25A	●25A	●25A	S 3
6.1	■400B	■400B	■405B	■405B	■400B	■400B	■400B	■400B	■400B	■400B	N 3
6.2	■400B	■400B	■405B	■405B	■400B	■400B	■400B	■400B	■400B	■400B	N 4
6.3	■400B	■400B	■405B	■405B	■400B	■400B	■400B	■400B	■400B	■400B	N 3
6.4	■60A	■60A	■60A	■60A	■60A	■60A	■60A	■60A	■60A	■60A	N 4
7.1	■800C	■800C	■805C	■805C	■800C	■800C	■800C	■800C	■800C	■800C	N 1
7.2	■800C	■800C	■805C	■805C	■800C	■800C	■800C	■800C	■800C	■800C	N 1
7.3	■700C	■700C	■705C	■705C	■700C	■700C	■700C	■700C	■700C	■700C	N 1
7.4	■340B	■340B	■345B	■345B	■340B	■340B	■340B	■340B	■340B	■340B	N 2
8.1	■340C	■340C	■345C	■345C	■340C	■340C	■340C	■340C	■340C	■340C	O
8.2	■210C	■210C	■215C	■215C	■210C	■210C	■210C	■210C	■210C	■210C	O
8.3	■180C	■180C	■185C	■185C	■180C	■180C	■180C	■180C	■180C	■180C	O
9.1											H
10.1	●200C	●200C	●210C	●205C	●200C	●200C	●200C	●200C	●200C	●200C	O

M

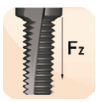

Ø	A		B		C	
	ap= 1 x d ₁	ap= 2 x d ₁	ap= 1 x d ₁	ap= 2 x d ₁	ap= 1 x d ₁	ap= 2 x d ₁
3,2	0,010	0,005	0,011	0,006	0,017	0,012
4,1	0,009	0,007	0,012	0,008	0,014	0,011
4,8	0,012	0,009	0,015	0,010	0,017	0,014
6,5	0,017	0,014	0,027	0,017	0,030	0,025
8,2	0,021	0,018	0,034	0,029	0,040	0,033
9,9	0,024	0,020	0,039	0,024	0,048	0,032
11,6	0,031	0,025	0,050	0,031	0,059	0,035
13,6	0,039	0,032	0,062	0,051	0,071	0,048
16	0,061	0,033	0,064	0,036	0,066	0,033
19	0,085	0,044	0,089	0,048	0,095	0,044

MF

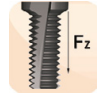

d ₁	P	A		B		C	
		ap= 3/4 x d ₁	ap= 1,5 x d ₁	ap= 3/4 x d ₁	ap= 1,5 x d ₁	ap= 3/4 x d ₁	ap= 1,5 x d ₁
4,8	0,5	0,017	0,014	0,022	0,018	0,025	0,021
6	0,75	0,023	0,018	0,033	0,027	0,037	0,030
6	1	0,020	0,016	0,029	0,023	0,032	0,026
8	1	0,025	0,020	0,041	0,033	0,045	0,037
10	1	0,034	0,028	0,055	0,045	0,069	0,056
10	1,5	0,028	0,023	0,045	0,037	0,056	0,046
12	1	0,048	0,039	0,077	0,065	0,077	0,075
12	1,5	0,040	0,032	0,065	0,053	0,076	0,062
14	1	0,060	0,049	0,084	0,079	0,084	0,084
14	1,5	0,049	0,040	0,079	0,064	0,084	0,074
16	2	0,050	0,041	0,082	0,066	0,089	0,077
20	2	0,067	0,055	0,100	0,093	0,100	0,100

UNC

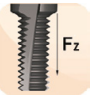

d ₁	P	A		B		C	
		ap= 1 x d ₁	ap= 2 x d ₁	ap= 1 x d ₁	ap= 2 x d ₁	ap= 1 x d ₁	ap= 2 x d ₁
4,8	20	0,003	0,003	0,012	0,006	0,029	0,014
5,5	18	0,004	0,003	0,017	0,009	0,041	0,023
7,5	16	0,008	0,005	0,029	0,016	0,056	0,043
8	14	0,008	0,006	0,031	0,018	0,060	0,049
10	13	0,009	0,007	0,040	0,032	0,071	0,071
10	12	0,008	0,006	0,038	0,029	0,071	0,069
12	11	0,009	0,007	0,036	0,026	0,077	0,077
14	10	0,010	0,008	0,060	0,043	0,084	0,084

UNF

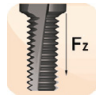

d ₁	P	A		B		C	
		ap= 1 x d ₁	ap= 2 x d ₁	ap= 1 x d ₁	ap= 2 x d ₁	ap= 1 x d ₁	ap= 2 x d ₁
4,8	0,004	0,003	0,016	0,008	0,034	0,021	
6	0,006	0,004	0,028	0,016	0,055	0,045	
8	0,013	0,007	0,037	0,025	0,063	0,058	
10	0,022	0,011	0,046	0,038	0,071	0,071	
14	0,036	0,018	0,075	0,061	0,084	0,084	

G

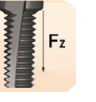

d ₁	A		B		C	
	ap= 1 x d ₁	ap= 2 x d ₁	ap= 1 x d ₁	ap= 2 x d ₁	ap= 1 x d ₁	ap= 2 x d ₁
3,2	0,010	0,005	0,011	0,006	0,017	0,012
4,1	0,009	0,007	0,012	0,008	0,014	0,011
4,8	0,012	0,009	0,015	0,010	0,017	0,014
6,5	0,017	0,014	0,027	0,017	0,030	0,025
16	0,061	0,033	0,064	0,036	0,066	0,033
19	0,085	0,044	0,089	0,048	0,095	0,044

NPT

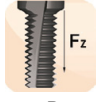

d ₁	Ap=	A	B	C
7,9	Standard	0,026	0,044	0,069
9,9	Standard	0,029	0,046	0,070
15,9	Standard	0,053	0,087	0,089
19,9	Standard	0,064	0,1	0,1

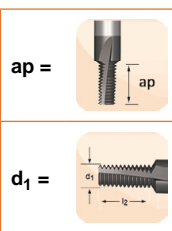

J200

- Fréza pro závit M se spirálovou drážkou 10°
- М Фреза для нарезания резьбы с углом наклона спирали 10°
- Frez do gwintów M z rowkiem spiralnym 10°
- Závit M, skrutková drážka 10°

Vnitřní závit
Внутренняя резьба
Gwint wewnętrzny
Vnútorý závit

J205

- Fréza pro závit M se spirálovou drážkou 10° s vnitřním chlazením
- М Фреза для нарезания резьбы с углом наклона спирали 10° с подводом СОЖ
- Frez do gwintów M z rowkiem spiralnym 10° z chłodzeniem wew.
- Závit M, skrutková drážka 10° vnútorné chladienie

Vnitřní závit
Внутренняя резьба
Gwint wewnętrzny
Vnútorý závit

J200	▪	1.1	1.2	1.3	1.4	1.5	1.6	3.1	3.2	3.3	3.4	4.1	4.2	4.3	6.1	6.2	6.3	6.4	7.1	7.2	7.3
		7.4	8.1	8.2	8.3																
	•	1.7	1.8	2.1	2.2	2.3	2.4	5.1	5.2	5.3	10.1										
J205	▪	1.1	1.2	1.3	1.4	1.5	1.6	2.1	2.2	2.3	2.4	3.1	3.2	3.3	3.4	4.1	4.2	4.3	5.1	5.2	6.1
		6.2	6.3	6.4	7.1	7.2	7.3	7.4	8.1	8.2	8.3										
	•	1.7	1.8	5.3	10.1																

J200	M		2XD	HM			DIN 6535HA	
J205	M		2XD	HM			DIN 6535HB	

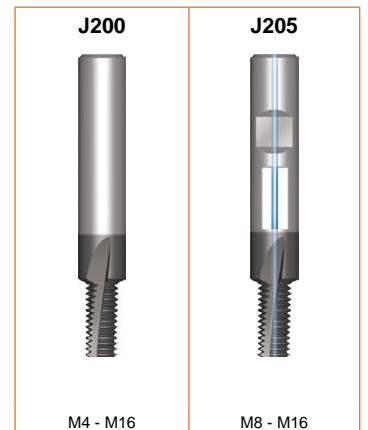
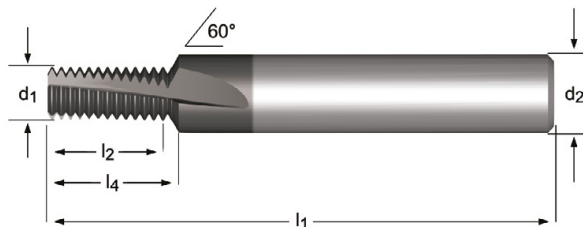

≥	P mm	d ₁ Ø mm	l ₂ mm	l ₁ mm	d ₂ Ø mm	z	l ₄ mm	J200	J205
M4	0.70	3.20	8.4	57	6	3	9.5	J2003.2X.7	
M5	0.80	4.10	11.2	57	6	3	12.1	J2004.1X.8	
M6	1.00	4.80	13.0	63	8	3	14.4	J2004.8X1.0	
M8	1.25	6.50	17.5	72	10	3	19.1	J2006.5X1.25	J2056.5X1.25
M10	1.50	8.20	21.0	83	12	3	22.8	J2008.2X1.5	J2058.2X1.50
M12	1.75	9.90	26.25	83	14	4	28.2	J2009.9X1.75	J2059.9X1.75
M14	2.00	11.60	30.0	92	16	4	32.2	J2011.6X2.0	J20511.6X2.0
M16	2.00	13.60	34.0	92	18	4	36.2	J2013.6X2.0	J20513.6X2.0

- ## J210
- Fréza pro závit M se spirálovou drážkou 27°
 - М Фреза для нарезания резьбы с углом наклона спирали 27°
 - Frez do gwintów M z rowkiem spiralnym 27°
 - Závit M, skrutková drážka 27°

Vnitřní závit
Внутренняя резьба
Gwint wewnętrzny
Vnúťorný závit

- ## J215
- Fréza pro závit M se spirálovou drážkou 27° s vnitřním chlazením
 - М Фреза для нарезания резьбы с углом наклона спирали 27° с подводом СОЖ
 - Frez do gwintów M z rowkiem spiralnym 27° z chłodzeniem wew.
 - Závit M, skrutková drážka 27° vnútorné chladienie

Vnitřní závit
Внутренняя резьба
Gwint wewnętrzny
Vnúťorný závit

J210; J215	1.1	1.2	1.3	1.4	1.5	1.6	3.1	3.2	3.3	3.4	4.1	4.2	4.3	6.1	6.2	6.3	6.4	7.1
	7.2	7.3	7.4	8.1	8.2	8.3												
	1.7	1.8	2.1	2.2	2.3	2.4	5.1	5.2	5.3	10.1								

J210	M	DORMER	2XD	HM	$\lambda 27^\circ$		DIN 6535HA	
J215	M	DORMER	2XD	HM	$\lambda 27^\circ$		DIN 6535HA	

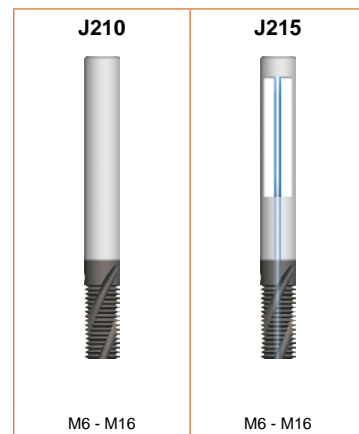
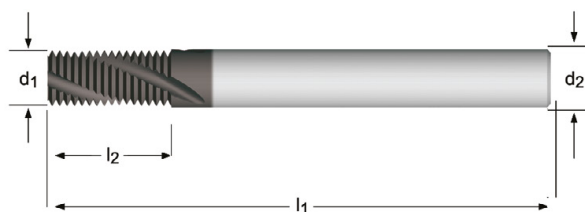

\geq	P mm	d ₁ ∅ mm	l ₂ mm	l ₁ mm	d ₂ ∅ mm	z	J210	J215
M6	1.00	4.50	13.0	57	6	3	J2104.5X1.0	J2154.5X1.0
M8	1.25	6.00	17.5	65	6	3	J2106.0X1.25	J2156.0X1.25
M10	1.50	7.50	21.0	72	8	3	J2107.5X1.5	J2157.5X1.5
M12	1.75	9.50	26.25	80	10	3	J2109.5X1.75	J2159.5X1.75
M14	2.00	10.00	30.0	83	10	4	J21010.0X2.0	J21510.0X2.0
M16	2.00	12.00	34.0	92	12	4	J21012.0X2.0	J21512.0X2.0

J220

- Fréza pro závit MF se spirálovou drážkou 10°
- MF Фреза для нарезания резьбы с углом наклона спирали 10°
- Frez do gwintów MF z rowkiem spiralnym 10°
- Závit MF, skrutková drážka 10°

Vnitřní závit
Внутренняя резьба
Gwint wewnętrzny
Vnútorný závit

J225

- Fréza pro závit MF se spirálovou drážkou 10° s vnitřním chlazením
- MF Фреза для нарезания резьбы с углом наклона спирали 10° с подводом СОЖ
- Frez do gwintów MF z rowkiem spiralnym 10° z chłodzeniem wew.
- Závit MF, skrutková drážka 10° vnútorné chladenie

Vnitřní závit
Внутренняя резьба
Gwint wewnętrzny
Vnútorný závit

J220	▪	1.1	1.2	1.3	1.4	1.5	1.6	3.1	3.2	3.3	3.4	4.1	4.2	4.3	6.1	6.2	6.3	6.4	7.1	7.2	7.3
		7.4	8.1	8.2	8.3																
	•	1.7	1.8	2.1	2.2	2.3	2.4	5.1	5.2	5.3	10.1										
J225	▪	1.1	1.2	1.3	1.4	1.5	1.6	2.1	2.2	2.3	2.4	3.1	3.2	3.3	3.4	4.1	4.2	4.3	5.1	5.2	5.3
		6.1	6.2	6.3	6.4	7.1	7.2	7.3	7.4	8.1	8.2	8.3									
	•	1.7	1.8	10.1																	

J220	MF		1.5XD	HM			DIN 6535HA	
J225	MF		1.5XD	HM			DIN 6535HB	

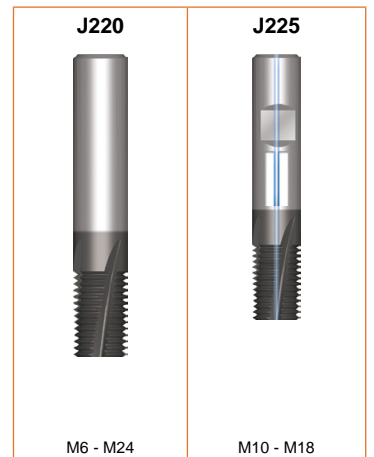
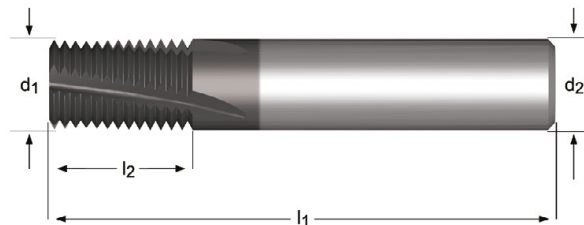

≧	P mm	d ₁ Ø mm	l ₂ mm	l ₁ mm	d ₂ Ø mm	z	J220	J225
M6	0.50	4.80	10.0	57	6	3	J2204.8X.5	
M8	0.75	6.00	12.0	57	6	3	J2206.0X.75	
M8	1.00	6.00	12.0	57	6	3	J2206.0X1.0	
M10	1.00	8.00	16.0	63	8	4	J2208.0X1.0	J2258.0X1.0
M12	1.00	10.00	20.0	72	10	4	J2210.0X1.0	J22510.0X1.0
M12	1.50	10.00	20.0	72	10	4	J22010.0X1.5	J22510.0X1.5
M14	1.00	12.00	22.0	83	12	4	J22012.0X1.0	J22512.0X1.0
M14	1.50	12.00	22.0	83	12	4	J22012.0X1.5	J22512.0X1.5
M16	1.00	14.00	26.0	83	14	5	J22014.0X1.0	J22514.0X1.0
M16	1.50	14.00	26.0	83	14	5	J22014.0X1.5	J22514.0X1.5
M18	1.50	16.00	30.0	92	16	5	J22016.0X1.5	J22516.0X1.5
M20	2.00	16.00	30.0	92	16	5	J22016.0X2.0	
M20	2.50	16.00	42.5	105	16	5	J22016.0X2.5	
M24	2.00	20.00	35.0	104	20	5	J22020.0X2.0	
M24	3.00	19.00	50.0	125	20	5	J22019.0X3.0	

J235

- Fréza pro závit UNC se spirálovou drážkou 10° s vnitřním chlazením
- UNC Фреза для нарезания резьбы с углом наклона спирали 10° с подводом СОЖ
- Frez do gwintów UNC z rowkiem spiralnym 10° z chłodzeniem wew.
- Závit UNC skrutková drážka 10° vnútorné chladienie

Vnitřní závit
Внутренняя резьба
Gwint wewnętrzny
Vnútorný závit

J235	▪	1.1	1.2	1.3	1.4	1.5	1.6	2.1	2.2	2.3	2.4	3.1	3.2	3.3	3.4	4.1	4.2	4.3	5.1	5.2	6.1
		6.2	6.3	6.4	7.1	7.2	7.3	7.4	8.1	8.2	8.3										
	•	1.7	1.8	5.3	10.1																

J235 **UNC**  **2XD** **HM**  **λ 10°**  **Alcrona Pro**  **DIN 6535HB** 

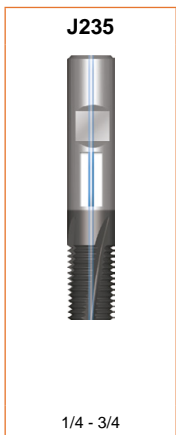
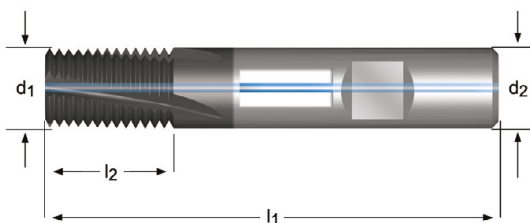

≥	TPI	d ₁ ∅ mm	l ₂ mm	l ₁ mm	d ₂ ∅ mm	z	J235
1/4	20	4.80	14.0	57	6	3	J2354.8-20
5/16	18	5.50	14.0	57	6	3	J2355.5-18
3/8	16	7.50	19.0	63	8	4	J2357.5-16
7/16	14	8.00	19.0	63	8	4	J2358.0-14
1/2	13	10.00	22.0	72	10	4	J23510.0-13
9/16	12	10.00	22.0	72	10	4	J23510.0-12
5/8	11	12.00	26.0	83	12	4	J23512.0-11
3/4	10	14.00	32.0	83	14	5	J23514.0-10

J245

- Fréza pro závit UNF se spirálovou drážkou 10° s vnitřním chlazením
- UNF Фреза для нарезания резьбы с углом наклона спирали 10° с подводом СОЖ
- Frez do gwintów UNF z rowkiem spiralnym 10° z chłodzeniem wew.
- Závit UNF skrutková drážka 10° vnútorné chladienie

Vnitřní závit
 Внутренняя резьба
 Gwint wewnętrzny
 Vnútorný závit

J245	▪	1.1	1.2	1.3	1.4	1.5	1.6	2.1	2.2	2.3	2.4	3.1	3.2	3.3	3.4	4.1	4.2	4.3	5.1	5.2	6.1
		6.2	6.3	6.4	7.1	7.2	7.3	7.4	8.1	8.2	8.3										
	•	1.7	1.8	5.3	10.1																

J245 UNF 2XD HM $\lambda 10^\circ$ Alcrona Pro DIN 6535HB

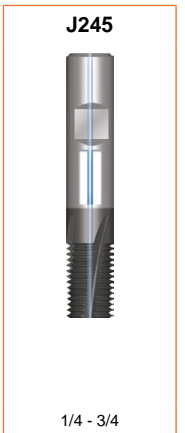
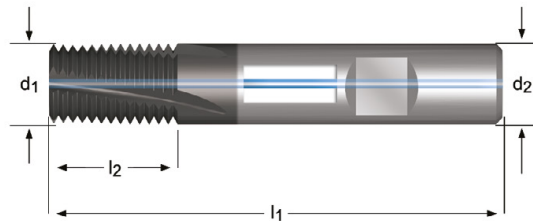

\geq	TPI	d_1 Ø mm	l_2 mm	l_1 mm	d_2 Ø mm	z	J245
1/4	28	4.80	14.0	57	6	3	J2454.8-28
5/16. 3/8	24	6.00	14.0	57	6	3	J2456.0-24
7/16. 1/2	20	8.00	19.0	63	8	4	J2458.0-20
9/16. 5/8	18	10.00	22.0	72	10	4	J24510.0-18
3/4	16	14.00	32.0	83	14	5	J24514.0-16

J280

- Fréza pro závit G(BSP) se spirálovou drážkou 10°
- G(BSP) Фреза для нарезания резьбы с углом наклона спирали 10°
- Frez do gwintów G(BSP) z rowkiem spiralnym 10°
- Závit G(BSP) skrutková drážka 10°

Vnitřní a vnější závit
 Внутренняя и наружная резьба
 Gwint wewnętrzny i zewnętrzny
 Vnúťorný a vonkajší závit

J280	▪	1.1	1.2	1.3	1.4	1.5	1.6	3.1	3.2	3.3	3.4	4.1	4.2	4.3	6.1	6.2	6.3	6.4	7.1	7.2	7.3
		7.4	8.1	8.2	8.3																
	•	1.7	1.8	2.1	2.2	2.3	2.4	5.1	5.2	5.3	10.1										

J280 **G** **DORMER** **1.5XD** **HM** $\lambda 10^\circ$ **Alcrona Pro** **DIN 6535HA**

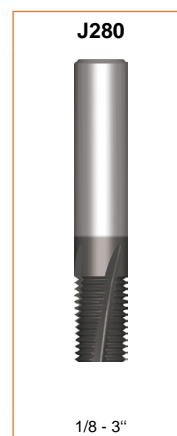
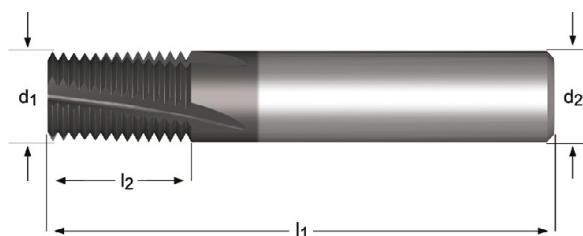

\geq	TPI	d_1 Ø mm	l_2 mm	l_1 mm	d_2 Ø mm	z	J280
1/8	28	6.00	15.0	57	6	3	J2806.0-28
1/4	19	10.00	20.0	72	10	4	J28010.0-19
3/8	19	14.00	26.0	83	14	5	J28014.0-19
1/2. 5/8	14	16.00	30.0	92	16	5	J28016.0-14
5/8. 3/4. 7/8	14	20.00	35.0	104	20	5	J28020.0-14
1". 3"	11	25.00	45.0	121	25	6	J28025.0-11

J260

- Fréza pro závit NPT se spirálovou drážkou 10°
 - NPT Фреза для нарезания резьбы с углом наклона спирали 10°
 - Frez do gwintów NPT z rowkiem spiralnym 10°
 - Závit NPT skrutková drážka 10°
- Vnitřní závit
Внутренняя резьба
Gwint wewnętrzny
Vnútorný závit

J260	▪	1.1	1.2	1.3	1.4	1.5	1.6	3.1	3.2	3.3	3.4	4.1	4.2	4.3	6.1	6.2	6.3	6.4	7.1	7.2	7.3
		7.4	8.1	8.2	8.3																
	•	1.7	1.8	2.1	2.2	2.3	2.4	5.1	5.2	5.3	10.1										

J260 NPT

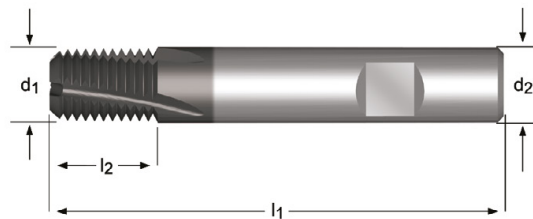

N	TPI	Ø _{d₁} mm	l ₂ mm	l ₁ mm	Ø _{d₂} mm	z	J260
1/8	27	7.90	11.50	58	8	3	J2607.9-27
1/4. 3/8	18	9.90	15.92	66	10	3	J2609.9-18
1/2. 3/4	14	15.90	20.46	82	16	4	J26015.9-14
1". 2"	11.5	19.90	27.12	92	20	5	J26019.9-11.5

E000	247	E258	250	E515	288	EP30	300
E000TIN	247	E260	256	E524	298	EP31	300
E001	247	E261	256	E531	308	EP40	321
E002	260	E263	250	E533	311	EP41	321
E002TIN	260	E266	249	E534	310	EX006G	252
E003	260	E268	269	E536	312	EX006H	252
E011	279	E275	287	E538	314	EX00TIN	252
E013	284	E278	297	E539	313	EX016H	252
E021	291	E282	319	E542	315	EX10	280
E023	293	E286	305	E544	317	EX10TIN	280
E031	301	E287	295	E545	316	EX11	280
E033	303	E288	285	E547	320	EX20	292
E041	322	E289	263	E550	328	EX21	292
E043	325	E290	269	E570	306	EX30	302
E100	230	E291	263	E600	240	EX31	302
E101	230	E292	263	E605	262	EX40	323

213 - 350



E102	230	E293	264	E606	248	EX41	323
E105	266	E294	263	E610	240	L000	342
E108	286	E295	265	E620	326	L001	343
E111	296	E296	265	E621	327	L002	344
E115	307	E297	243	E650	261	L110	348
E119	318	E298	254	E651	294	L112	349
E200	232	E299	277	E653	332	L113	339
E201	234	E300	282	E654	304	L114	340
E207	250	E303	239	E708	335	L115	341
E212	250	E382	324	E709	334	L119	337
E216	249	E383	283	E710	330	L120	345
E225	287	E384	278	E711	331	L126	338
E229	297	E390	234	E712	333	T200	226
E237	232	E412	255	E714	329	T201	226
E238	257	E414	258	E720	334	T205	228
E239	257	E422	249	E721	330	T206	228
E240	245	E423	249	EP006G	241	T210	226
E241	245	E471	246	EP006H	241	T215	229
E242	269	E472	246	EP00TiN	241		
E243	336	E473	259	EP016H	241		
E250	232	E474	259	EP10	275		
E251	232	E500	235	EP10TIN	275		
E252	234	E501	235	EP11	275		
E255	244	E504	235	EP20	290		
E256	244	E513	271	EP21	290		

	Typ závitů	Тип резьбы	Typ Gwintu	Typ závitů
	Standard	Стандарт	Standard	Štandard
	Tolerance	Допуск	Tolerancja	Tolerancia
	Typ díry	Тип отверстия	Rodzaj otworu	Typ diery
	Hĺoubka	Глубина	Głębokość	Hĺbka
	Materiál	Материал	Materiał	Materiál
	Náběhy	Заборный конус	Nakrój	Náběhy
	Geometrie drážek	Геометрия канавки метчика	Geometria ostrza	Geometria drážok
	Směr otáčení	Направление	Kierunek	Smer
	Povlak	Покрытие	Pokrycie	Povlak
	Chlazení	СОЖ	Chłodziwo	Chladienie
■	vynikající	Основное применение	Najlepsze zastosowanie	Vynikajúce
●	dobry	Возможное применение	Dobre zastosowanie	Dobré
	Příklad 10 = řezná rychlost (m/min) +/- 10%	Пример: 10 = Скорость резания в м/мин +/- 10%	Na przyklad 10 = prędkość skrawania w m/min +/- 10%	Príklad 10 = rezná rýchlosť (m/min) +/- 10%
	Kód	Код	Kod	Kód
	Rozměrová řada	Ассортимент	Zakres	Rozsah rozmerov
AMG	Česky	Русский	Polski	Slovensky
1.1	magneticky měkká	Автоматная сталь	magnetyczna miękka	Magneticky mäkká oceľ
1.2	konstrukční uhlíkatá	Низкоуглеродистая сталь	konstrukcyjna do nawęglania	Konstruktívna oceľ,uhlíková
1.3	uhlíkatá	Углеродистая нелегированная сталь	węglowa	Uhlíková oceľ
1.4	legovaná	Легированная сталь	stopowa	Legovaná oceľ
1.5	legovaná, tvrzená a temperovaná	Легированная сталь после отжига	stopowa-hartowana i odpuszczana	Legovaná oceľ, tvrdená a temperovaná
1.6	legovaná, tvrzená a temperovaná	Высоколегированная сталь после отжига	stopowa-hartowana i odpuszczana	Legovaná oceľ, tvrdená a temperovaná
1.7	legovaná, tvrzená	Легированная закаленная сталь	stopowa-hartowana	Legovaná oceľ tvrdená
1.8	legovaná, tvrzená	Легированная закаленная сталь	stopowa-hartowana	Legovaná oceľ tvrdená, oceľ odolná oproti opotrebovaniu
2.1	automatová	Ферритная нержавеющая сталь	automatowa	Automatová nehrdzavejúca oceľ
2.2	austenitická	Аустенитная нержавеющая сталь	austenitczna	Austenická
2.3	fertická+austenitická	Ферритно-аустенитная нержавеющая сталь	ferrytyczna+austenitczna	Feriticko austenitická nehr. oceľ (Duplex)
2.4	precipitačně tvrzená	Сталь дисперсионного твердения	Utwardzane wydzieleniowo	Tvrdená nehr. oceľ
3.1	lamelární	Серый чугун	szare	Sivá liatina
3.2	lamelární	Ковкий чугун	szare	Sivá liatina
3.3	nodulární	Высокопрочный чугун	sferoidalne ciągliwe	Tvárna liatina
3.4	nodulární	Высокопрочный чугун	sferoidalne ciągliwe	Tvárna liatina
4.1	čistý	Технически чистый титан	niestopowy	Čistý titán
4.2	slitiny	Титановые сплавы	stopy tytanu	Zliatiny titánu
4.3	slitiny	Титановые сплавы	stopy tytanu	Zliatiny titánu
5.1	čistý	Технически чистый никель	niestopowy	Čistý nikel
5.2	slitiny	Никелевые сплавы	stopy niklu	Zliatiny niklu
5.3	slitiny	Никелевые сплавы	stopy niklu	Zliatiny niklu
6.1	bronz	Технически чистая медь	niestopowa	Bronz
6.2	β - mosaz, bronz	Бронза	Mosiądz-β,brąz	β - mosadz, bronz
6.3	bronz mosaz	Латунь	Mosiądz CuZn	Mosadz, bronz
6.4	bronz vysokopevnostní	Высокопрочная бронза	Brąz o wysokiej wytrzymałości	Vysokopevnostný bronz
7.1	Al, Mg, tvářené	Технически чистый алюминий/магний	Al.,Mg, niestopowe	Al, Mg, tvárnený (čistý)
7.2	Al slitiny, Si<0.5%	Сплавы Al с содержанием Si<0.5%	Al. Stopowe,Si<0,5%	Al zliatiny, Si<0,5%
7.3	Al slitiny, Si>0.5%<10%	Сплавы Al с содержанием 0.5%<Si<10%	Al. Stopowe,Si>0,5%<10%	Al zliatiny, Si>0,5%<10%
7.4	Al slitiny, Si>10%	Сплавы Al с содержанием Si>10%	Al. Stopowe,Si>10%	Al zliatiny, Si>10%
8.1	termosty	Термопластики	Tworzywa termoplastyczne	Termoplasty
8.2	termosty	Терморезактивные полимеры	Tworzywa termoutwardzalne	Termosety
8.3	zpevněné plasty	Армированные полимеры	Zbrojone tworzywa sztuczne	Spevnené plasty
9.1	cermet (keramika)	Металлокерамика	Cermetale	Cermet (kov-keramika)
10.1	standardni grafit	Технический графит	Grafit standartowy	Grafit

	M	M	M	M	M	M	M	M	M	M	M	M	M	M	M	M	
	DIN 371	DIN 371 \leq 10 376 \geq 12	DIN 371	DIN 371 \leq 10 376 \geq 12	DIN 371 \leq 10 376 \geq 12	DIN 2174	DIN 352	DIN 352	DIN 352	DIN 371	DIN 376	DIN 371	DIN 376	DIN 371	DIN 376	DIN 371 \leq 10 376 \geq 12	
	6H	6HX	6HX	6H	6H	6HX	6H	6HX	6H	6H	6H	6H	6H	6HX	6HX	6HX	
	2XD	2.5XD	2XD	2XD	2.5XD	3XD	1.5XD	1.5XD	1.5XD	1.5XD	1.5XD	1.5XD	1.5XD	2XD	2XD	2XD	
	HM	HM	HM	HM	HM	HM	HSS	HSS-E	HSS	HSS-E PM	HSS-E PM	HSS-E PM	HSS-E PM	HSS-E PM	HSS-E PM	HSS-E PM	
	C 2-3	C 2-3	C 2-3	C 2-3	C 2-3	C 2-3.5	C 2-3	C 2-3	C 2-3	A 6-8 C 2-3	A 6-8 C 2-3	C 2-3	C 2-3	C 2-3	C 2-3	C 2-3	
				$\lambda 15^\circ$ 	$\lambda 15^\circ$ 												
	TICN	Super B	TICN			TICN		ST						ST	ST	TiAIN	
	T200	T201	T210	T205	T206	T215	E100	E102	E101	E200	E250	E237	E251	E201	E252	E390	
	M3 - M12	M5 - M16	M3 - M12	M3 - M12	M5 - M12	M3 - M10	M1.6 - M52	M3 - M30	M4 - M16	M2 - M10	M3 - M52	M3 - M10	M12 - M24	M3 - M10	M8 - M24	M3 - M20	
AMG	226	226	226	228	228	229	230	230	230	232	232	232	232	234	234	234	ISO
1.1						■60	●1	●1	●1	●12	●12	●12	●12				P 1
1.2						■60	●1	●1	●1	●10	●10	●10	●10				P 1
1.3						■60	●1	●1	●1	●8	●8	●8	●8				P 2
1.4						■40	●1	●1	●1	●6	●6	●6	●6				P 3
1.5						■30	●1	●1	●1	●5	●5	●5	●5				P 4
1.6																	H 1
1.7	■6		●6														H 3
1.8	●4		■4														H 4
2.1						■25		●1									M 1
2.2						■25		●1									M 3
2.3						■25		●1									M 2
2.4						●25											S 2
3.1	●60	■60		●40	●40		●1	●1	●1	●14	●14	●14	●14	■15	■15	■30	K 1
3.2	●30	■25		●15	●15		●1	●1	●1	●8	●8	●8	●8	■8	■8	■25	K 2
3.3		●38		■25	■25		●1	●1	●1	●12	●12	●12	●12	■15	■15	■35	K 3
3.4		●33		■15	■15		●1	●1	●1					●8	●8	●25	K 4
4.1								●1									S 1
4.2								●1									S 2
4.3								●1									S 3
5.1						■35		●1									S 1
5.2						●15		●1									S 2
5.3								●1									S 3
6.1						●40	●1	●1	●1								N 3
6.2							●1	●1	●1	●16	●16	●16	●16	●20	●20	●30	N 4
6.3						●80	●1	●1	●1	●12	●12	●12	●12				N 3
6.4	●7	●10					●1	●1	●1					●5	●5	●5	N 4
7.1						■70											N 1
7.2						■80	●1	●1	●1	●20	●20	●20	●20				N 1
7.3		●50		■35	■35	■80	●1	●1	●1	●12	●12	●12	●12				N 1
7.4	●60	■40		■30	■30		●1	●1	●1					●15	●15	●20	N 2
8.1																	O
8.2	●50	●25		●25	●25		●1	●1	●1	●8	●8	●8	●8	■10	■10	■15	O
8.3	●30	●15		●15	●15		●1	●1	●1								O
9.1																	H
10.1	●25	■25															O

	M	M	M	M	M	M	M	M	M	M	M	M	M	M	M	M	
	ISO 529	ISO 529	ISO 529	DIN 357	ISO 2283	ISO 2283	DIN 3714<10 376>12	DIN 3714<10 376>12	DIN 3714<10 376>12	DIN 3714<10 376>12	DIN 3714<10 376>12	DIN 3714<10 376>12	DIN 3714<10 376>12	DIN 3714<10 376>12	DIN 3714<10 376>12	DIN 3714<10 376>12	
	6H	6H	6H	6H	6H	6H	6H	6G	6H	6H	6H	6H	6H	6H	6H	6H	
	1.5XD	1.5XD	1.5XD	2XD	1.5XD	1.5XD	2.5XD	2.5XD	2.5XD	2.5XD	2.5XD	2.5XD	2.5XD	2.5XD	2.5XD	2.5XD	
	HSS	HSS	HSS	HSS-E	HSS-E PM	HSS-E PM	HSS-E PM	HSS-E PM	HSS-E PM	HSS-E PM	HSS-E PM	HSS-E PM	HSS-E PM	HSS-E PM	HSS-E PM	HSS-E PM	
				D18-20 C 2-3	C 2-3	C 2-3	B 3.5-5	B 3.5-5	B 3.5-5	B 3.5-5	B 3.5-5	B 3.5-5	B 3.5-5	B 3.5-5	B 3.5-5	B 3.5-5	
			TiN			TiN			TiN	ST	Cr		TiAIN Top	ST	Super B		
	E500	E501	E504	E303	E600	E610	EP006H	EP006G	EP00TiN	EP016H	E297	E255	E256	E240	E241	E471	
	M1 - M56	M3 - M24	M3 - M24	M3 - M20	M3 - M30	M3 - M16	M2 - M30	M3 - M20	M3 - M30	M2 - M30	M3 - M30	M3 - M20	M3 - M20	M3 - M30	M3 - M20	M3 - M20	
											SHARK LINE	SHARK LINE	SHARK LINE	SHARK LINE	SHARK LINE	SHARK LINE	
AMG	235	235	235	239	240	240	241	241	241	241	243	244	244	245	245	246	ISO
1.1	●7	●7	●14	●12	●7	●14	■25	■25	■40	■25	■25					●25	P 1
1.2	●6	●6	●12	●10	●6	●12	■22	■22	■40	■22	■22					●22	P 1
1.3	●5	●5	●10	●8	●5	●10	■18	■18	■32	■18	■18					●18	P 2
1.4	●4	●4	●8	●6	●4	●8	■16	■16	■27	■16	●16	■16	■30			●16	P 3
1.5	●3	●3	●6	●5	●3	●6	■10	■10	■13	■10	●10	●7	■17	●7	●10		P 4
1.6							●5	●5	●11	●5		●4	●11				H 1
1.7																	H 3
1.8																	H 4
2.1									■8	●7				■8	■14		M 1
2.2									■7	●6			■7	■10			M 3
2.3									●5	●4			■5	■6			M 2
2.4																	S 2
3.1	●12	●12	■18	●14	●12	■18	●15	●15	●22	●15							K 1
3.2	●7	●7	■12	●8	●7	■12	●8	●8	●18	●8							K 2
3.3	●10	●10	■22	●12	●10	■22	●15	●15	●25	●15							K 3
3.4	●5	●5	●12		●5	●12	●8	●8	●18	●8							K 4
4.1							●10	●10	●15								S 1
4.2							●5	●5	●7			●2	●3				S 2
4.3																	S 3
5.1							●12	●12	●18								S 1
5.2							●5	●5	●8			●2	●3				S 2
5.3																	S 3
6.1	●4	●4			●4		■12	■12	■18		■12					●12	N 3
6.2	●10	●10	●20	●16	●10	●20	●30	●30	●45		●30					■30	N 4
6.3	●7	●7	●14	●12	●7	●14	■20	■20	■35		■20					■20	N 3
6.4	●2	●2	●4		●2	●4											N 4
7.1							■16	■16								■16	N 1
7.2	●12	●12	●24	●20	●12	●24	■35	■35								■35	N 1
7.3	●7	●7	●14	●12	●7	●14	■20	■20	■30							●20	N 1
7.4	●5	●5	●10		●5	●10	■15	■15	■22							●15	N 2
8.1							●30	●30								■25	O
8.2	●5	●5	●10	●8	●5	●10			●45								O
8.3	●3	●3	●6		●3	●6											O
9.1																	H
10.1																	O

	M	M	M	M	M	M	M	M	M	M	M	M	M	M	M	M	
	DIN 371<10 376>12	ISO 529	ISO 529	ISO 529	ISO 2283	DIN 371	DIN 376	DIN 371	DIN 376	DIN 371	DIN 376	DIN 371	DIN 376	DIN 371<10 376>12	DIN 371<10 376>12	DIN 371<10 376>12	
	6H	6H	6H	6H	6H	6H	6H	6H	6H	6H	6H	6H	6H	6H	6G	6H	
	2.5XD	2.5XD	2.5XD	2.5XD	2.5XD	3XD	3XD	3XD	3XD	1.5XD	1.5XD	1.5XD	1.5XD	2.5XD	2.5XD	2.5XD	
	HSS-E PM	HSS-E PM	HSS-E PM	HSS-E PM	HSS-E PM	HSS-E PM	HSS-E PM	HSS-E PM	HSS-E PM	HSS-E PM	HSS-E PM	HSS-E PM	HSS-E PM	HSS-E PM	HSS-E PM	HSS-E PM	
	B 3.5-5	B 3.5-5	B 3.5-5	B 3.5-5	B 3.5-5	B 3.5-5	B 3.5-5	B 3.5-5	B 3.5-5	C 2-3	C 2-3	C 2-3	C 2-3	C 2-3	C 2-3	C 2-3	
	$\lambda 15^\circ$	$\lambda 15^\circ$	$\lambda 15^\circ$	$\lambda 15^\circ$	$\lambda 15^\circ$	$\lambda 15^\circ$	$\lambda 15^\circ$	$\lambda 15^\circ$	$\lambda 15^\circ$	$\lambda 15^\circ$	$\lambda 15^\circ$	$\lambda 15^\circ$	$\lambda 15^\circ$	$\lambda 45^\circ$	$\lambda 45^\circ$	$\lambda 45^\circ$	
	Super B		TiN	ST				TiN	TiN			TiN	TiN			TiN	
	E472	E000	E000TiN	E001	E606	E216	E266	E422	E423	E207	E258	E212	E263	EX006H	EX006G	EX00TiN	
	M3 - M20	M1.6 - M24	M3 - M20	M1.6 - M24	M3 - M24	M3 - M10	M12 - M24	M3 - M10	M12 - M24	M2 - M10	M4 - M36	M3 - M10	M12 - M36	M2 - M64	M3 - M20	M3 - M30	
AMG	246	247	247	247	248	249	249	249	249	250	250	250	250	252	252	252	ISO
1.1		■25	■40	■25	●20	●22	●22	●35	●35			●35	●35	■25	■25	■40	P 1
1.2	●40	■22	■40	■22	●18	■20	■20	■35	■35	●20	●20	●35	●35	■22	■22	■40	P 1
1.3	●32	■18	■32	■18	●14	■16	■16	■28	■28	■16	■16	■28	■28	■18	■18	■32	P 2
1.4		■16	■27	■16	●10	■12	■12	■24	■24	■12	■12	■24	■24	■16	■16	■27	P 3
1.5		■10	■13	■10	●5	●7	●7	●10	●10	●7	●7	●10	●10	■10	■10	■13	P 4
1.6		●5	●11	●5	●3												H 1
1.7																	H 3
1.8																	H 4
2.1			■8	●7	●6											■8	M 1
2.2			■7	●6	●4											■7	M 3
2.3			●5	●4	●3											●5	M 2
2.4																	S 2
3.1		●15	●22	●15		●12	●12	●18	●18							●22	K 1
3.2		●8	●18	●8		●7	●7	●15	●15							●18	K 2
3.3		●15	●25	●15		●10	●10	●20	●20							●25	K 3
3.4		●8	●18	●8		●5	●5	●15	●15							●18	K 4
4.1		●10	●15			●15	●15	●27	●27					●10	●10	●15	S 1
4.2		●5	●7									●10	●10	●5	●5	●7	S 2
4.3					●3	●4	●4	●5	●5			●7	●7				S 3
5.1		●12	●18		●10	●12	●12	●20	●20					●12	●12	●18	S 1
5.2		●5	●8		●4	●5	●5	●8	●8					●5	●5	●8	S 2
5.3																	S 3
6.1		■12	■18		●10	●12	●12	●18	●18								N 3
6.2	■45	■30	■45			●30	●30	●45	●45								N 4
6.3	■35	■20	■35		●15	●20	●20	●35	●35								N 3
6.4																	N 4
7.1	●35	■16			●10	●16	●16	●25	●25					■16	■16		N 1
7.2	■45	■35			●25	●35	●35	●45	●45	●30	●30	●35	●35	■35	■35		N 1
7.3	■30	■20	■30		●13	●20	●20	●30	●30	●15	●15	●20	●20	■20	■20	■30	N 1
7.4	■20	■15	■22		●10	●15	●15	●20	●20					■15	■15	■22	N 2
8.1	●30	●30			●20	●25	●25	●30	●30								O
8.2			●45														O
8.3																	O
9.1																	H
10.1																	O

	M	M	M	M	M	M	M	M	M	M	M	M	M	M	M	M	
	DIN 371 \leq 10 376 \geq 12	DIN 371 \leq 10 376 \geq 12	DIN 371 \leq 10 376 \geq 12	DIN 371 \leq 10 376 \geq 12	DIN 371 \leq 10 376 \geq 12	DIN 371 \leq 10 376 \geq 12	DIN 371 \leq 10 376 \geq 12	DIN 371 \leq 10 376 \geq 12	DIN 371 \leq 10 376 \geq 12	DIN 371 \leq 10 376 \geq 12	DIN 371 \leq 10 376 \geq 12	ISO 529	ISO 529	ISO 529	DORMER ISO 2283	DIN 2174	
	6H	6H	6H	6H	6H	6H	6H	6H	6H	6H	6H	6H	6H	6H	6H	6HX	
	HSS-E PM	HSS-E PM	HSS-E PM	HSS-E PM	HSS-E PM	HSS-E PM	HSS-E PM	HSS-E PM	HSS-E PM	HSS-E PM	HSS-E PM	HSS-E PM	HSS-E PM	HSS-E PM	HSS	HSS-E PM	HSS-E
	C 2-3	C 2-3	C 2-3	C 2-3	C 2-3	C 2-3	C 2-3	C 2-3	C 2-3	C 2-3	C 2-3	C 2-3	C 2-3	C 2-3	C 2-3	C 2-3	C 2-3.5
	SHARK LINE	SHARK LINE	SHARK LINE	SHARK LINE	SHARK LINE	SHARK LINE	SHARK LINE	SHARK LINE	SHARK LINE	SHARK LINE							
	EX016H	E298	E412	E260	E261	E238	E239	E414	E473	E474	E002	E002TIN	E003	E650	E605	E291	
	M2 - M64	M3 - M30	M3 - M30	M3 - M20	M3 - M20	M3 - M30	M3 - M20	M3 - M20	M3 - M20	M3 - M20	M2 - M24	M3 - M20	M2 - M24	M3 - M16	M3 - M20	M1.6 - M16	
AMG	252	254	255	256	256	257	257	258	259	259	260	260	260	261	262	263	ISO
1.1	■25	■25	■50						●25		■25	■40	■25	●25		■30	P 1
1.2	■22	■22	■50						●22	●40	■22	■40	■22	●22	●18	■27	P 1
1.3	■18	■18	■35						●18	●32	●18	■32	■18	●18	●14	■23	P 2
1.4	■16	●16	■30	■16	■35				●16	●27	■16	■27	■16	●15	●10	■20	P 3
1.5	■10	●10	■16	●7	■20	●7			●10	●13	■10	■13	■10		●5		P 4
1.6				●4	●11												H 1
1.7																	H 3
1.8																	H 4
2.1	■7		●14			■8	■14	■16				■8	●7		●6		M 1
2.2	■6		●10			■7	■10	■12				■7	●6		●4		M 3
2.3	●4		●6			■5	■6	■8				●5	●4		●3		M 2
2.4								■6									S 2
3.1												●22					K 1
3.2												●18		●8			K 2
3.3												●25					K 3
3.4												●18					K 4
4.1												●10		●15			S 1
4.2				●2	●3							●5		●7			S 2
4.3																	S 3
5.1												●12		●18			S 1
5.2				●2	●3							●5		●8		●4	S 2
5.3																	S 3
6.1		■12							●12								N 3
6.2		●30							■30	■45				●30			N 4
6.3		■20							■20	●35				●20			N 3
6.4																	N 4
7.1			●16						■16	●35	■16			●18	●10	■26	N 1
7.2			●16						■35	■45	■35			●35	●25	■38	N 1
7.3			●35						■20	■30	■20	■30			●13	●22	N 1
7.4			●35						●15	■20	■15	■22			●10		N 2
8.1									■25	●30				●30			O
8.2																	O
8.3																	O
9.1																	H
10.1																	O











	M	M	M	M	M	M	MF	MF	MF	MF	MF	MF	MF	MF	MF	
	DIN 2174	DIN 2174	DIN 2174	DIN 2174	DIN 2174	DIN 2174	DIN 2181	DIN 374	DIN 371	DIN 374	ISO 529	DIN 374	DIN 374	DIN 374	DIN 374	
	6HX	6HX	6HX	6HX	6GX	6GX	6H	6H	6H	6H	6H	6H	6H	6H	6H	
	HSS-E	HSS-E	HSS-E	HSS-E	HSS-E	HSS-E	HSS	HSS-E PM	HSS-E PM	HSS-E PM	HSS	HSS-E PM	HSS-E PM	HSS-E PM	HSS-E PM	
	C 2-3.5	C 2-3.5	C 2-3.5	E 1.5-2	C 2-3.5	E 1.5-2	C 2-3	C 2-3	C 2-3	C 2-3		B 3.5-5	B 3.5-5	B 3.5-5	B 3.5-5	
	E292	E294	E289	E293	E295	E296	E105	E268	E242	E290	E513	EP10	EP10TIN	EP11	E299	
	M1.6 - M16	M3 - M16	M5 - M12	M3 - M16	M3 - M12	M3 - M10	M2.5 - M50	M4 - M50	M8 - M10	M12 - M24	M3 - M50	M4 - M30	M8 - M20	M4 - M30	M4 - M30	
AMG	263	263	263	264	265	265	266	269	269	269	271	275	275	275	277	ISO
1.1	■55	■55	■55	■55	■55	■55	●1	●12	●12	●12	●7	■25	■40	■25	■25	P 1
1.2	■50	■50	■50	■50	■50	■50	●1	●10	●10	●10	●6	■22	■40	■22	■22	P 1
1.3	■45	■45	■45	■45	■45	■45	●1	●8	●8	●8	●5	■18	■32	■18	■18	P 2
1.4	■40	■40	■40	■40	■40	■40	●1	●6	●6	●6	●4	■16	■27	■16	●16	P 3
1.5	●20	●20	●20	●20	●20	●20	●1	●5	●5	●5	●3	■10	■13	■10	●10	P 4
1.6												●5	●11	●5		H 1
1.7																H 3
1.8																H 4
2.1	■18	■18	■18	■18	■18	■18						■8	●7			M 1
2.2	■15	■15	■15	■15	■15	■15						■7	●6			M 3
2.3	●10	●10	●10	●10	●10	●10						●5	●4			M 2
2.4																S 2
3.1							●1	●14	●14	●14	●12	●15	●22	●15		K 1
3.2							●1	●8	●8	●8	●7	●8	●18	●8		K 2
3.3							●1	●12	●12	●12	●10	●15	●25	●15		K 3
3.4							●1				●5	●8	●18	●8		K 4
4.1	■35	■35	■35	■35	■35	■35						●10	●15			S 1
4.2												●5	●7			S 2
4.3																S 3
5.1	■20	■20	■20	■20	■20	■20						●12	●18			S 1
5.2	●8	●8	●8	●8	●8	●8						●5	●8			S 2
5.3																S 3
6.1	●25	●25	●25	●25	●25	●25	●1				●4	■12	■18		■12	N 3
6.2							●1	●16	●16	●16	●10	■30	■45		●30	N 4
6.3	●40	●40	●40	●40	●40	●40	●1	●12	●12	●12	●7	■20	■35		■20	N 3
6.4							●1				●2					N 4
7.1	■55	■55	■55	■55	■55	■55						■16				N 1
7.2	■55	■55	■55	■55	■55	■55	●1	●20	●20	●20	●12	■35				N 1
7.3	■40	■40	■40	■40	■40	■40	●1	●12	●12	●12	●7	■20	■30			N 1
7.4	●25	●25	●25	●25	●25	●25	●1				●5	■15	■22			N 2
8.1												●30				O
8.2							●1	●8	●8	●8	●5		●45			O
8.3							●1				●3					O
9.1																H
10.1																O

	MF	MF	MF	MF	MF	MF	MF	MF	MF	UNC	UNC	UNC	UNC	UNC	UNC	UNC	UNC	
	DIN 374	ISO 529	DIN 374	DIN 374	DIN 374	DIN 374	DIN 374	ISO 529	DIN 2174	DIN 352	DIN 371	DIN 376	ISO 529	DIN 2184-1	DIN 2184-1	ISO 529	DIN 2184-1	
	6H	6H	6H	6H	6H	6H	6H	6H	6HX	2B	2B	2B	2B	2B	2B	2B	2B	
	2.5XD	2.5XD	2.5XD	2.5XD	2.5XD	2XD	2XD	2.5XD	3XD	1.5XD	1.5XD	1.5XD	1.5XD	2.5XD	2.5XD	2.5XD	2.5XD	
	HSS-E PM	HSS-E PM	HSS-E PM	HSS-E PM	HSS-E PM	HSS-E PM	HSS-E PM	HSS-E PM	HSS-E	HSS	HSS-E PM	HSS-E PM	HSS	HSS-E PM	HSS-E PM	HSS-E PM	HSS-E PM	
	B 3.5-5	B 3.5-5	C 2-3	C 2-3	C 2-3	C 2-3	C 2-3	C 2-3	C 2-3.5	C 2-3	C 2-3	C 2-3		B 3.5-5	B 3.5-5	B 3.5-5	C 2-3	
			$\lambda 45^\circ$	$\lambda 45^\circ$	$\lambda 45^\circ$	$\lambda 40^\circ$	$\lambda 40^\circ$	$\lambda 45^\circ$									$\lambda 45^\circ$	
	ST	ST		TiN	ST	Cr	ST	ST	TiN							ST	ST	
	E384	E011	EX10	EX10TiN	EX11	E300	E383	E013	E288	E108	E225	E275	E515	EP20	EP21	E021	EX20	
	M6 - M20	M4 - M24	M4 - M30	M8 - M20	M4 - M30	M4 - M30	M6 - M20	M4 - M22	M5 - M12	No.5 - 1"	No.2 - 1/4	5/16 - 1.1/2	No.1 - 2"	No.4 - 1"	No.4 - 1"	No.2 - 1"	No.4 - 1"	
AMG	278	279	280	280	280	282	283	284	285	286	287	287	288	290	290	291	292	ISO
1.1		■25	■25	■40	■25	■25		■25	■55	●1	●12	●12	●7	■25	■25	■25	■25	P 1
1.2		■22	■22	■40	■22	■22		■22	■50	●1	●10	●10	●6	■22	■22	■22	■22	P 1
1.3		■18	■18	■32	■18	■18		■18	■45	●1	●8	●8	●5	■18	■18	■18	■18	P 2
1.4		■16	■16	■27	■16	●16		■16	■40	●1	●6	●6	●4	■16	■16	■16	■16	P 3
1.5	●7	■10	■10	■13	■10	●10	●7	■10	●20	●1	●5	●5	●3	■10	■10	■10	■10	P 4
1.6		●5												●5	●5	●5		H 1
1.7																		H 3
1.8																		H 4
2.1	■8	●7		■8	■7		■8	●7	■18						●7	●7		M 1
2.2	■7	●6		■7	■6		■7	●6	■15						●6	●6		M 3
2.3	■5	●4		●5	●4		■5	●4	●10						●4	●4		M 2
2.4																		S 2
3.1		●15		●22						●1	●14	●14	●12	●15	●15	●15		K 1
3.2		●8		●18						●1	●8	●8	●7	●8	●8	●8		K 2
3.3		●15		●25						●1	●12	●12	●10	●15	●15	●15		K 3
3.4		●8		●18						●1			●5	●8	●8	●8		K 4
4.1			●10	●15					■35					●10			●10	S 1
4.2			●5	●7										●5			●5	S 2
4.3																		S 3
5.1			●12	●18					■20					●12			●12	S 1
5.2			●5	●8					●8					●5			●5	S 2
5.3																		S 3
6.1						■12			●25	●1			●4	■12				N 3
6.2						●30				●1	●16	●16	●10	■30				N 4
6.3						■20			●40	●1	●12	●12	●7	■20				N 3
6.4										●1			●2					N 4
7.1			■16						■55					■16			■16	N 1
7.2			■35						■55	●1	●20	●20	●12	■35			■35	N 1
7.3			■20	■30					■40	●1	●12	●12	●7	■20			■20	N 1
7.4			■15	■22					●25	●1			●5	■15			■15	N 2
8.1														●30				O
8.2										●1	●8	●8	●5					O
8.3										●1			●3					O
9.1																		H
10.1																		O





	UNC	UNC	UNC	UNC	UNF	UNF	UNF	UNF	UNF	UNF	UNF	UNF	UNF	UNF	UNF	UN	BSW		
	DIN 2184-1	ISO 529	DORMER DIN	DIN 2184-1	DIN 2181	DIN 371	DIN 374	ISO 529	DIN 2184-1	DIN 2184-1	ISO 529	DIN 2184-1	DIN 2184-1	ISO 529	DORMER DIN	DIN 2184-1	ISO 529	DIN 351	
	2B	2B	2B	2BX	2B	2B	2B	2B	2B	2B	2B	2B	2B	2B	Medium	2BX	2B	Medium	
	HSS-E PM	HSS-E PM	HSS	HSS-E	HSS	HSS-E PM	HSS-E PM	HSS	HSS-E PM	HSS-E PM	HSS-E PM	HSS-E PM	HSS-E PM	HSS-E PM	HSS	HSS-E	HSS	HSS	
	C	C	C	C	C	C	C		C	C	B	C	C	C	C	C	C	C	
	2-3	2-3	2-3	2-3.5	2-3	2-3	2-3		2-3	2-3	3.5-5	2-3	2-3	2-3	2-3	2-3.5	2-3	2-3	
	No.4 - 1"	No.2 - 1"	No.6 - 5/8"	No.4 - 1/2"	No.5 - 1"	No.2 - 1/4"	5/16 - 1.1/2"	No.0 - 1.1/2"	No.8 - 1"	No.8 - 1"	No.8 - 1"	No.8 - 1"	No.8 - 1"	No.8 - 1"	No.8 - 5/8"	No.4 - 1/2"	1/4 - 1.5/16"	1/8 - 1"	
AMG	292	293	294	295	296	297	297	298	300	300	301	302	302	303	304	305	306	307	ISO
1.1	■25	■25	●25	■55	●1	●12	●12	●7	■25	■25	■25	■25	■25	■25	●25	■55	●7	●1	P 1
1.2	■22	■22	●22	■50	●1	●10	●10	●6	■22	■22	■22	■22	■22	■22	●22	■50	●6	●1	P 1
1.3	■18	■18	●18	■45	●1	●8	●8	●5	■18	■18	■18	■18	■18	■18	●18	■45	●5	●1	P 2
1.4	■16	■16	●15	■40	●1	●6	●6	●4	■16	■16	■16	■16	■16	■16	●15	■40	●4	●1	P 3
1.5	■10	■10		●20	●1	●5	●5	●3	■10	■10	■10	■10	■10	■10		●20	●3	●1	P 4
1.6									●5	●5	●5				●5				H 1
1.7																			H 3
1.8																			H 4
2.1	■7	●7		■18					●7	●7			■7	●7		■18			M 1
2.2	■6	●6		■15					●6	●6			■6	●6		■15			M 3
2.3	●4	●4		●10					●4	●4			●4	●4		●10			M 2
2.4																			S 2
3.1					●1	●14	●14	●12	●15	●15	●15						●12	●1	K 1
3.2			●8		●1	●8	●8	●7	●8	●8	●8				●8		●7	●1	K 2
3.3					●1	●12	●12	●10	●15	●15	●15						●10	●1	K 3
3.4					●1			●5	●8	●8	●8						●5	●1	K 4
4.1				■35					●10			●10				■35			S 1
4.2								●5				●5							S 2
4.3																			S 3
5.1				■20				●12				●12				■20			S 1
5.2				●8				●5				●5				●8			S 2
5.3																			S 3
6.1				●25	●1			●4	■12							●25	●4	●1	N 3
6.2			●30		●1	●16	●16	●10	●30						●30		●10	●1	N 4
6.3			●20	●40	●1	●12	●12	●7	■20					●20	●40	●7	●1	●1	N 3
6.4					●1			●2									●2	●1	N 4
7.1			●18	■55					■16			■16			●18	■55			N 1
7.2			●35	■55	●1	●20	●20	●12	■35			■35			●35	■55	●12	●1	N 1
7.3				■40	●1	●12	●12	●7	■20			■20				■40	●7	●1	N 1
7.4				●25	●1			●5	■15			■15				●25	●5	●1	N 2
8.1			●30						●30										O
8.2					●1	●8	●8	●5									●5	●1	O
8.3					●1			●3									●3	●1	O
9.1																			H
10.1																			O

	BSW	BSW	BSW	BSF	BSF	BSF	BA	BA	BA	G	G	G	G	G	G	G	
	ISO 529	ISO 529	ISO 529	ISO 529	ISO 529	ISO 529	ISO 529	ISO 529	ISO 529	DIN 5157	DIN 5156	ISO 2284	DIN 5156	DIN 5156	DORMER ISO	DIN 5156	
	Medium	Medium	Medium	Medium	Medium	Medium	Normal	Normal	Normal	Normal	Normal	Normal	Normal	Normal	Normal	Normal	
	1.5XD	2.5XD	2XD	1.5XD	2.5XD	2XD	1.5XD	2.5XD	2XD	1.5XD	1.5XD	1.5XD	2.5XD	2.5XD	2.5XD	2.5XD	
	HSS	HSS	HSS	HSS	HSS	HSS	HSS	HSS	HSS	HSS	HSS-E PM	HSS	HSS-E PM	HSS-E PM	HSS-E PM	HSS-E PM	
		B 3.5-5	C 2-3		B 3.5-5	C 2-3		B 3.5-5	C 2-3	C 2-3	C 2-3		B 3.5-5	B 3.5-5	B 3.5-5	C 2-3	
	E531	E534	E533	E536	E539	E538	E542	E545	E544	E119	E282	E547	EP40	EP41	E041	EX40	
	1/8 - 1"	1/8 - 3/4	1/8 - 3/4	3/16 - 1"	1/4 - 1/2	1/4 - 1/2	No.10 - No.0	No.10 - No.2	No.8 - No.2	1/8 - 3"	1/8 - 1.1/2	1/8 - 2"	1/8 - 1"	1/8 - 1"	1/8 - 3/4	1/8 - 1.1/2	
AMG	308	310	311	312	313	314	315	316	317	318	319	320	321	321	322	323	ISO
1.1	●7	■20		●22	■20		●7	■20		●1	●12	●7	■25	■25	■25	■25	P 1
1.2	●6	■18	■18	●20	■18	■18	●6	■18	■18	●1	●10	●6	■22	■22	■22	■22	P 1
1.3	●5	■14	■14	●16	■14	■14	●5	■14	■14	●1	●8	●5	■18	■18	■18	■18	P 2
1.4	●4	■10	■10	●12	■10	■10	●4	■10	■10	●1	●6	●4	■16	■16	■16	■16	P 3
1.5	●3	●5	●5	●7	●5	●5	●3	●5	●5	●1	●5	●3	■10	■10	■10	■10	P 4
1.6		●3		●4	●3			●3					●5	●5	●5		H 1
1.7																	H 3
1.8																	H 4
2.1		■6	■6	●7	■6	■6		●6	■6						●7	●7	M 1
2.2		■4	■4	●5	■4	■4		●4	■4						●6	●6	M 3
2.3		■3	■3	●7	■3	■3		●3	■3						●4	●4	M 2
2.4																	S 2
3.1	●12			●12			●12			●1	●14	●12	●15	●15	●15		K 1
3.2	●7			●7			●7			●1	●8	●7	●8	●8	●8		K 2
3.3	●10			●10			●10			●1	●12	●10	●15	●15	●15		K 3
3.4	●5			●5			●5			●1		●5	●8	●8	●8		K 4
4.1													●10			●10	S 1
4.2													●5			●5	S 2
4.3		●3			●3			●3									S 3
5.1		●10			●10			●10					●12			●12	S 1
5.2		●4	●4		●4	●4		●4	●4				●5			●5	S 2
5.3																	S 3
6.1	●4	●10		■12	●10		●4	●10		●1		●4	■12				N 3
6.2	●10			●30			●10			●1	●16	●10	●30				N 4
6.3	●7	●15		●20	●15		●7	●15		●1	●12	●7	■20				N 3
6.4	●2			●4			●2			●1		●2					N 4
7.1		●10	●10		●10	●10		●10	●10				■16			■16	N 1
7.2	●12	●25	●25	●35	●25	●25	●12	●25	●25	●1	●20	●12	■35			■35	N 1
7.3	●7	●13	●13	●20	●13	●13	●7	●13	●13	●1	●12	●7	■20			■20	N 1
7.4	●5	●10	●10	●15	●10	●10	●5	●10	●10	●1		●5	■15			■15	N 2
8.1		●20			●20			●20					●30				O
8.2	●5			●12			●5			●1	●8	●5					O
8.3	●3			●7			●3			●1		●3					O
9.1																	H
10.1																	O

	G	G	G	EGM	EGM	Rc	NPT	NPT	NPT	NPT	NPT	NPTF	NPSF	NPSF	NPSM	PG	
	DIN 5156	DIN 5156	DORMER ISO	DORMER ISO	DORMER ISO	ISO 2284	DORMER ANSI	ANSI B94.9	ANSI B94.9	ANSI B94.9	ANSI	ANSI B94.9	ANSI B94.9	ANSI B94.9	ANSI B94.9	DIN 40432	
	Normal	Normal	Normal	6H	6H	Normal	Normal	Normal	Normal	Normal	Normal	Normal	Normal	Normal	Normal	Normal	
	2.5XD	2XD	2.5XD	1.5XD	2XD	1.5XD	1.5XD	1.5XD	1.5XD	1.5XD	1.5XD	1.5XD	1.5XD	1.5XD	1.5XD	1.5XD	
	HSS-E PM	HSS-E PM	HSS-E PM	HSS	HSS	HSS	HSS-E PM	HSS	HSS	HSS	HSS	HSS	HSS	HSS	HSS	HSS	
	C 2-3	C 2-3	C 2-3	C 2-3	C 2-3	C 2-3	C 2-3	C 2-3	C 2-3	C 2-3		C 2-3	C 2-3	C 2-3	C 2-3		
	$\lambda 45^\circ$	$\lambda 40^\circ$	$\lambda 45^\circ$		$\lambda 40^\circ$						$\lambda 27^\circ$						
	ST	ST	ST						TiN					TiN			
	EX41	E382	E043	E620	E621	E550	E714	E710	E721	E711	E653	E712	E709	E720	E708	E243	
	1/8 - 1.1/2	1/8 - 1"	1/8 - 3/4	M3 - M16	M3 - M16	1/8 - 2"	1/8 - 1"	1/16 - 2"	1/8 - 1"	1/8 - 1.1/2	1/8 - 1"	1/16 - 1.1/4	1/8 - 3/4	1/8 - 3/4	1/8 - 1"	No.7 - No.36	
AMG	323	324	325	326	327	328	329	330	330	331	332	333	334	334	335	336	ISO
1.1	■25		■25	●7		●22	●4	●4	●4	●4	●25	●4	●4	●4	●4	●12	P 1
1.2	■22		■22	●6	●18	●20	●4	●4	●4	●4	●22	●4	●4	●4	●4	●10	P 1
1.3	■18		■18	●5	●14	●16	●6	●6	●6	●6	●18	●6	●6	●6	●6	●8	P 2
1.4	■16		■16	●4	●10	●12	■5	●5	■5	■5	●15	■5	■5	■5	■5	●6	P 3
1.5	■10	●7	■10	●3	●5	●7	●3	●3	●3	●3		●3	●3	●3	●3	●5	P 4
1.6			●5			●4											H 1
1.7																	H 3
1.8																	H 4
2.1	■7	■8	●7		●6	●7											M 1
2.2	■6	■7	●6		●4	●5											M 3
2.3	●4	■5	●4		●3	●7											M 2
2.4																	S 2
3.1				●12		■12	●6	●6	■6	●6		●6	●6	■6	●6	●14	K 1
3.2				●7		■7	●4	●4	■4	●4	●8	●4	●4	■4	●4	●8	K 2
3.3				●10		■10	●6	●6	■6	●6		●6	●6	■6	●6	●12	K 3
3.4				●5		■5	●4	●4	■4	●4		●4	●4	■4	●4		K 4
4.1																	S 1
4.2																	S 2
4.3																	S 3
5.1																	S 1
5.2					●4												S 2
5.3																	S 3
6.1			●4			■12											N 3
6.2			●10			●30	●11	●11	●11	●11	●30	●11	●11	●11	●11	●16	N 4
6.3			●7			●20					●20					●12	N 3
6.4			●2			●4											N 4
7.1				●10							●18						N 1
7.2				●12	●25	●35					●35					●20	N 1
7.3				●7	●13	●20	●11	●11	●11	●11		●11	●11	●11	●11	●12	N 1
7.4				●5	●10	●15	●7	●7	●7	●7		●7	●7	●7	●7		N 2
8.1							●4	●4	●4	●4	●30	●4	●4	●4	●4		O
8.2				●5		●12										●8	O
8.3				●3		●7											O
9.1																	H
10.1																	O

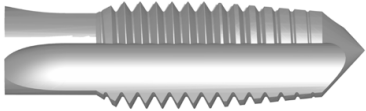

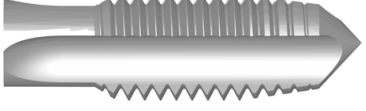
												
	L119	L126	L113	L114	L115	L000	L001	L002	L120	L110	L112	
	Set	Set	Set	Set	Set	Set	Set	Set	Set	16.00 - 4"	BT1 - No.7	
AMG	337	338	339	340	341	342	343	344	345	348	349	ISO
1.1												P 1
1.2												P 1
1.3												P 2
1.4												P 3
1.5												P 4
1.6												H 1
1.7												H 3
1.8												H 4
2.1												M 1
2.2												M 3
2.3												M 2
2.4												S 2
3.1												K 1
3.2												K 2
3.3												K 3
3.4												K 4
4.1												S 1
4.2												S 2
4.3												S 3
5.1												S 1
5.2												S 2
5.3												S 3
6.1												N 3
6.2												N 4
6.3												N 3
6.4												N 4
7.1												N 1
7.2												N 1
7.3												N 1
7.4												N 2
8.1												O
8.2												O
8.3												O
9.1												H
10.1												O

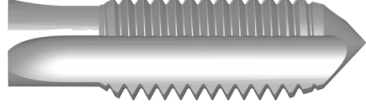
NO1 - NO9

NO1 =		A 6-8	
NO2 =		B 4-6	
NO3 =		C 2-3	

ISO	NO6 = NO1 + NO2 + NO3
	NO7 = NO2 + NO3 *

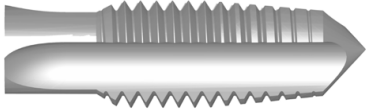
ANSI	NO6 = NO1 (taper) + NO2 (plug) + NO3 (bottoming)
------	--

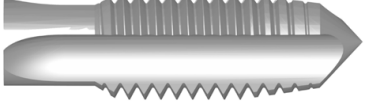
NO4 =		A 6-8	
NO5 =		B 3.5-5	

DIN	NO8 = NO3 + NO4 + NO5
ISO	NO9 = NO3 + NO4

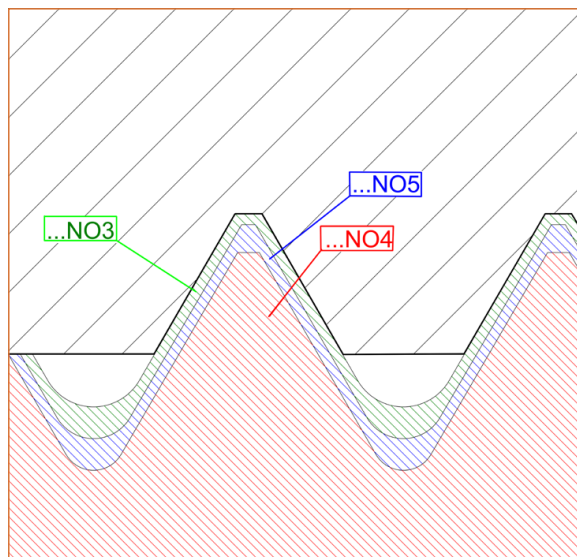

* E550
E710 NO7 = NO3 (truncated) + NO3

- T200**
- M strojní závitník
 - M Машинные метчики с прямой стружечной канавкой
 - M Gwintownik maszynowy, prosty rowek wiórowy
 - M strojový závitník

- T201**
- M strojní závitník, přímá drážka, vnitřní chlazení
 - M Машинный метчик с прямой канавкой и внутренним подводом СОЖ
 - M Gwintownik maszynowy prosty metryczny, chłodzenie wewnętrzne
 - M strojový závitník s priamou drážkou a vnútorným chladením

- T210**
- M strojní závitník
 - M Машинные метчики с прямой стружечной канавкой
 - M Gwintownik maszynowy, prosty rowek wiórowy
 - M strojový závitník

T200

▪	1.7
•	1.8 3.1 3.2 6.4 7.4 8.2 8.3 10.1

T201

▪	3.1 3.2 7.4 10.1
•	3.3 3.4 6.4 7.3 8.2 8.3

T210

▪	1.8
•	1.7

T200	M	DIN 371	6H		2XD	HM	C 2-3			TiCN	
T201	M	DIN 371 ≤ 10 376 ≥ 12	6HX		2.5XD	HM	C 2-3			Super B	
T210	M	DIN 371	6HX		2XD	HM	C 2-3			TiCN	

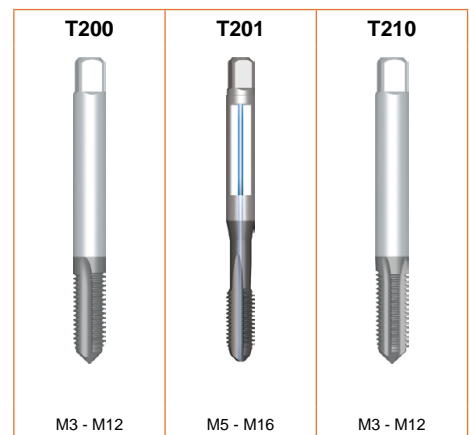
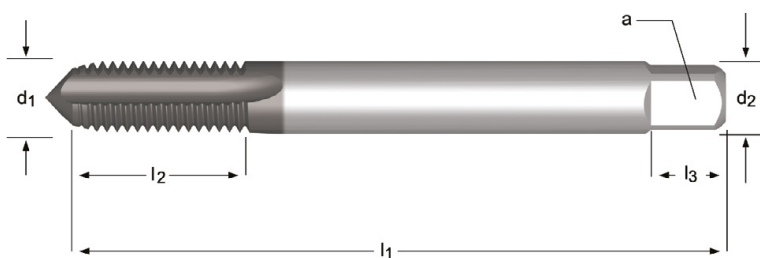

M	P mm	l ₁ mm	l ₂ mm	d ₂ Ø mm	□ a mm	l ₃ mm	z		l ₄ mm	T200	T201	T210
3	0.50	56	10	3.5	2.7	6	3	2.6	-	T200M3		
3	0.50	56	8	3.5	2.7	6	4	2.6	-			T210M3
4	0.70	63	11	4.5	3.4	6	5	3.4	-			T210M4
4	0.70	63	13	4.5	3.4	6	3	3.4	-	T200M4		
5	0.80	70	13.5	6.0	4.9	8	5	4.3	-			T210M5
5	0.80	70	16	6.0	4.9	8	3	4.3	-	T200M5		
5	0.80	70	16	6.0	4.9	8	4	4.3	-		T201M5	
6	1.00	80	16.5	6.0	4.9	8	5	5.1	-			T210M6
6	1.00	80	19	6.0	4.9	8	3	5.1	30	T200M6		
6	1.00	80	19	6.0	4.9	8	4	5.1	30		T201M6	
8	1.25	90	21.5	8.0	6.2	9	5	6.9	-			T210M8
8	1.25	90	22	8.0	6.2	9	3	6.9	35	T200M8		

M	P mm	l ₁ mm	l ₂ mm	d ₂ ∅ mm	□ a mm	l ₃ mm	z		l ₄ mm	T200	T201	T210
8	1.25	90	22	8.0	6.2	9	4	6.9	35		T201M8	
10	1.50	100	24	10.0	8.0	11	3	8.7	39	T200M10		
10	1.50	100	24	10.0	8.0	11	4	8.7	39		T201M10	
10	1.50	100	27	10.0	8.0	11	5	8.7				T210M10
12	1.75	110	23	9.0	7.0	10	3	10.4	-	T200M12		
12	1.75	110	23	9.0	7.0	10	4	10.4	-		T201M12	
12	1.75	110	32	12.0	9.0	12	6	10.4				T210M12
16	2.00	110	25	12.0	9.0	12	4	14.25	-		T201M16	

- ## T205
- M strojní závitník, šroubovice 15°
 - M Машинные метчики со спиральной стружечной канавкой 15°
 - M Gwintownik maszynowy skrętny 15°
 - M strojový závitník, skrutkovica 15°

- ## T206
- M strojní závitník, šroubovice 15°, vnitřní chlazení
 - M Машинный метчик со спиральной канавкой 15° и внутренним подводом СОЖ
 - M Gwintownik maszynowy skrętny 15°, chłodzenie wewnętrzne
 - M strojový závitník, skrutkovica 15°, vnútorné chladenie

T205; T206	▪	3.3	3.4	7.3	7.4
	•	3.1	3.2	8.2	8.3

T205	M	DIN 371≤10 376≥12	6H		2XD	HM	C 2-3				
T206	M	DIN 371≤10 376≥12	6H		2.5XD	HM	C 2-3				

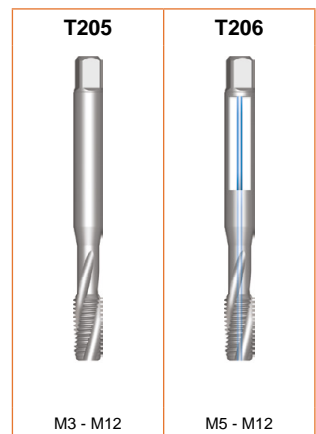
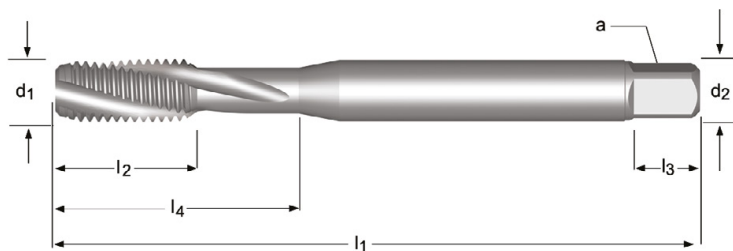

M	P mm	l ₁ mm	l ₂ mm	d ₂ ∅ mm	a mm	l ₃ mm	z		l ₄ mm	T205	T206
3	0.50	56	10	3.5	2.7	6	3	2.6	-	T205M3	
4	0.70	63	13	4.5	3.4	6	3	3.4	-	T205M4	
5	0.80	70	16	6.0	4.9	8	3	4.3	-	T205M5	T206M5
6	1.00	80	19	6.0	4.9	8	3	5.1	30	T205M6	T206M6
8	1.25	90	22	8.0	6.2	9	3	6.9	35	T205M8	T206M8
10	1.50	100	24	10.0	8.0	11	3	8.7	39	T205M10	T206M10
12	1.75	110	23	9.0	7.0	10	3	10.4	-	T205M12	T206M12

T215

- M strojní tvářecí závitník
- M Метчик-раскатник
- M Wygniatak maszynowy
- M strojový tvárňiaci závitník

T215 ■ 1.1 1.2 1.3 1.4 1.5 2.1 2.2 2.3 5.1 7.1 7.2 7.3
 • 2.4 5.2 6.1 6.3

T215 M DIN 2174 6HX 3XD HM C 2-3.5 TICN

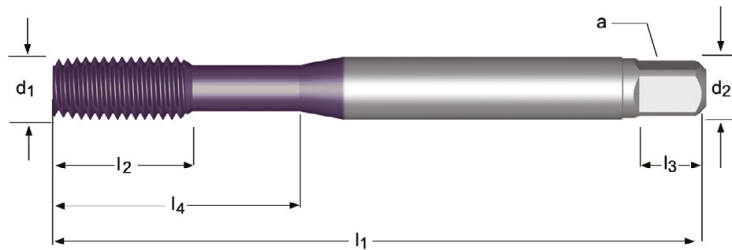

M	P mm	l ₁ mm	l ₂ mm	d ₂ ∅ mm	∠ a mm	l ₃ mm	z		l ₄ mm	T215
3	0.50	56	10	3.5	2.7	6	4	2.8	-	T215M3
4	0.70	63	13	4.5	3.4	6	5	3.7	-	T215M4
5	0.80	70	16	6.0	4.9	8	5	4.6	-	T215M5
6	1.00	80	19	6.0	4.9	8	5	5.5	30	T215M6
8	1.25	90	22	8.0	6.2	9	5	7.4	35	T215M8
10	1.50	100	24	10.0	8.0	11	5	9.3	39	T215M10

- E100** • M Závítník ruční, přímá drážka
E102 • M Ручные метчики с прямой стружечной канавкой
E101 • M Gwintownik ręczny, prosty rowek wiórowy
 • M Závítník ručný, priama drážka

E100	•	1.1	1.2	1.3	1.4	1.5	3.1	3.2	3.3	3.4	6.1	6.2	6.3	6.4	7.2	7.3	7.4	8.2	8.3		
E102	•	1.1	1.2	1.3	1.4	1.5	2.1	2.2	2.3	3.1	3.2	3.3	3.4	4.1	4.2	4.3	5.1	5.2	5.3	6.1	6.2
		6.3	6.4	7.2	7.3	7.4	8.2	8.3													
E101	•	1.1	1.2	1.3	1.4	1.5	3.1	3.2	3.3	3.4	6.1	6.2	6.3	6.4	7.2	7.3	7.4	8.2	8.3		

E100	M	DIN 352	6H		1.5XD	HSS	C 2-3					
E102	M	DIN 352	6HX		1.5XD	HSS-E	C 2-3			ST		
E101	M	DIN 352	6H		1.5XD	HSS	C 2-3					

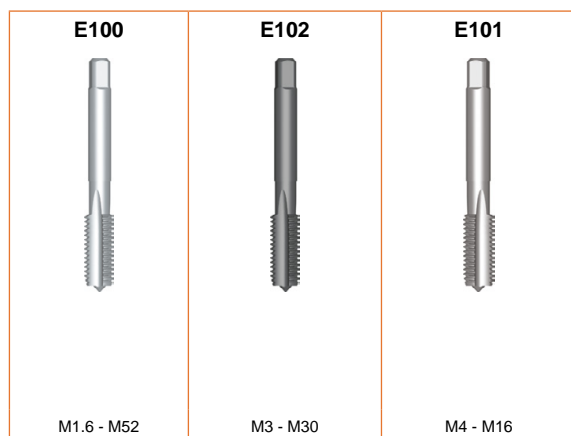
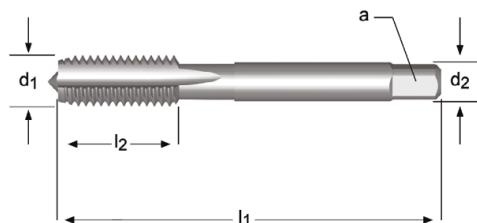

M	P mm	l ₁ mm	l ₂ mm	d ₂ Ø mm	□ a mm	z		E100	E102	E101
1.6	0.35	32	7	2.5	2.1	3	1.25	E100M1.6NO3		
1.6	0.35	32	7	2.5	2.1	3	1.25	E100M1.6NO8		
2	0.40	36	8	2.8	2.1	3	1.6	E100M2NO3	NO1 - NO9 	
2	0.40	36	8	2.8	2.1	3	1.6	E100M2NO8		
2.5	0.45	40	9	2.8	2.1	3	2.05	E100M2.5NO3		
2.5	0.45	40	9	2.8	2.1	3	2.05	E100M2.5NO8		
3	0.50	40	10	3.5	2.7	3	2.5	E100M3NO3		
3	0.50	40	10	3.5	2.7	3	2.5	E100M3NO8	E102M3NO8	¹⁾
3.5	0.60	45	10	4.0	3.0	3	2.9	E100M3.5NO3		
3.5	0.60	45	10	4.0	3.0	3	2.9	E100M3.5NO8		
4	0.70	45	12	4.5	3.4	3	3.3	E100M4NO3		E101M4NO3
4	0.70	45	12	4.5	3.4	3	3.3	E100M4NO8	E102M4NO8	¹⁾ E101M4NO8
5	0.80	50	14	6.0	4.9	3	4.2	E100M5NO3		E101M5NO3
5	0.80	50	14	6.0	4.9	3	4.2	E100M5NO8	E102M5NO8	¹⁾ E101M5NO8
6	1.00	56	16	6.0	4.9	3	5	E100M6NO3		E101M6NO3
6	1.00	56	16	6.0	4.9	3	5	E100M6NO8	E102M6NO8	¹⁾ E101M6NO8
7	1.00	56	16	6.0	4.9	3	6	E100M7NO3		
7	1.00	56	16	6.0	4.9	3	6	E100M7NO8		
8	1.25	63	19	6.0	4.9	3	6.8	E100M8NO3		E101M8NO3
8	1.25	63	19	6.0	4.9	3	6.8	E100M8NO8	E102M8NO8	¹⁾ E101M8NO8
9	1.25	63	20	7.0	5.5	3	7.8	E100M9NO3		
9	1.25	63	20	7.0	5.5	3	7.8	E100M9NO8		
10	1.50	70	22	7.0	5.5	3	8.5	E100M10NO3		E101M10NO3
10	1.50	70	22	7.0	5.5	3	8.5	E100M10NO8	E102M10NO8	¹⁾ E101M10NO8

¹⁾ NO4 s vodícím kolíkem / NO4 с направляющими / NO4 z prowadzeniem / NO4 s vodiacim čarom

M	P mm	l ₁ mm	l ₂ mm	d ₂ Ø mm	□ a mm	z		E100	E102	E101
12	1.75	75	25	9.0	7.0	4	10.3	E100M12NO3		E101M12NO3
12	1.75	75	25	9.0	7.0	4	10.3	E100M12NO8	E102M12NO8 ¹⁾	E101M12NO8
14	2.00	80	25	11.0	9.0	4	12	E100M14NO3		E101M14NO3
14	2.00	80	25	11.0	9.0	4	12	E100M14NO8	E102M14NO8 ¹⁾	E101M14NO8
16	2.00	80	25	12.0	9.0	4	14	E100M16NO3		E101M16NO3
16	2.00	80	25	12.0	9.0	4	14	E100M16NO8	E102M16NO8 ¹⁾	E101M16NO8
18	2.50	95	32	14.0	11.0	4	15.5	E100M18NO3		
18	2.50	95	32	14.0	11.0	4	15.5	E100M18NO8	E102M18NO8 ¹⁾	
20	2.50	95	32	16.0	12.0	4	17.5	E100M20NO3		
20	2.50	95	32	16.0	12.0	4	17.5	E100M20NO8	E102M20NO8 ¹⁾	
22	2.50	100	34	18.0	14.5	4	19.5	E100M22NO3		
22	2.50	100	34	18.0	14.5	4	19.5	E100M22NO8		
24	3.00	110	38	18.0	14.5	4	21	E100M24NO3		
24	3.00	110	38	18.0	14.5	4	21	E100M24NO8	E102M24NO8 ¹⁾	
27	3.00	110	38	20.0	16.0	4	24	E100M27NO3		
27	3.00	110	38	20.0	16.0	4	24	E100M27NO8	E102M27NO8 ¹⁾	
30	3.50	125	45	22.0	18.0	4	26.5	E100M30NO3		
30	3.50	125	45	22.0	18.0	4	26.5	E100M30NO8	E102M30NO8 ¹⁾	
33	3.50	125	50	25.0	20.0	4	29.5	E100M33NO3		
33	3.50	125	50	25.0	20.0	4	29.5	E100M33NO8		
36	4.00	150	56	28.0	22.0	4	32	E100M36NO3		
36	4.00	150	56	28.0	22.0	4	32	E100M36NO8		
39	4.00	150	60	32.0	24.0	4	35	E100M39NO3		
39	4.00	150	60	32.0	24.0	4	35	E100M39NO8		
42	4.50	150	60	32.0	24.0	4	37.5	E100M42NO3		
42	4.50	150	60	32.0	24.0	4	37.5	E100M42NO8		
45	4.50	160	65	36.0	29.0	6	40.5	E100M45NO3		
45	4.50	160	65	36.0	29.0	6	40.5	E100M45NO8		
48	5.00	180	70	36.0	29.0	6	43	E100M48NO3		
48	5.00	180	70	36.0	29.0	6	43	E100M48NO8		
52	5.00	180	70	40.0	32.0	6	47	E100M52NO3		
52	5.00	180	70	40.0	32.0	6	47	E100M52NO8		

NO1 - NO9



219

¹⁾ NO4 s vodičím kolíkem / NO4 с направляющими / NO4 z prowadzeniem / NO4 s vodičím čarom

E200

• M strojní závitník

Do vyprodání skladu dodáváno v HSS-E

E250

• M Машинные метчики с прямой стружечной канавкой

HSS-E до складирования новой продукции

E237

• M Gwintownik ręczny, prosty rowek wiórowy

Do wyczerpania obecnych zapasów magazynowych dostepny ze stali HSS-E

E251

• M strojový závitník

Do vypredania skladu dodávané v HSS-E

E200; E250; E237; E251 • 1.1 1.2 1.3 1.4 1.5 3.1 3.2 3.3 6.2 6.3 7.2 7.3 8.2

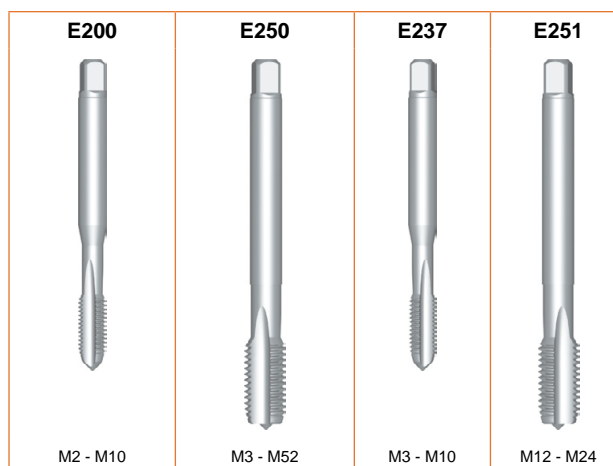
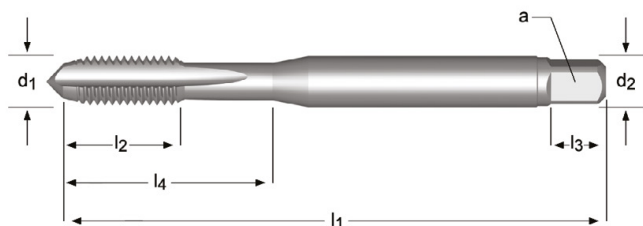

E200	M	DIN 371	6H		1.5XD	HSS-E PM	A 6-8 C 2-3				
E250	M	DIN 376	6H		1.5XD	HSS-E PM	A 6-8 C 2-3				
E237	M	DIN 371	6H		1.5XD	HSS-E PM	C 2-3				
E251	M	DIN 376	6H		1.5XD	HSS-E PM	C 2-3				



M	P mm	l ₁ mm	l ₂ mm	d ₂ ∅ mm	a mm	l ₃ mm	z		l ₄ mm	E200	E250	E237	E251
2	0.40	45	6	2.8	2.1	5	3	1.6	9	E200M2			
2.5	0.45	50	8	2.8	2.1	5	3	2.05	12.5	E200M2.5			
3	0.50	56	10	2.2	2.1	5	3	2.5			E250M3		
3	0.50	56	9	3.5	2.7	6	3	2.5	18	E200M3		E237M3	
3	0.50	56	9	3.5	2.7	6	3	2.5	18	E200M3NO1			
4	0.70	63	12	2.8	2.1	5	3	3.3			E250M4		
4	0.70	63	12	4.5	3.4	6	3	3.3	21	E200M4		E237M4	
4	0.70	63	12	4.5	3.4	6	3	3.3	21	E200M4NO1			
5	0.80	70	13	3.5	2.7	6	3	4.2			E250M5		
5	0.80	70	13	6.0	4.9	8	3	4.2	25	E200M5		E237M5	
5	0.80	70	13	6.0	4.9	8	3	4.2	25	E200M5NO1			
6	1.00	80	15	4.5	3.4	6	3	5.0			E250M6		
6	1.00	80	15	6.0	4.9	8	3	5	30	E200M6		E237M6	
6	1.00	80	15	4.5	3.4	6	3	5.0			E250M6NO1		
6	1.00	80	15	6.0	4.9	8	3	5	30	E200M6NO1			
8	1.25	90	18	6.0	4.9	8	3	6.8			E250M8		
8	1.25	90	18	8.0	6.2	9	3	6.8	35	E200M8		E237M8	
8	1.25	90	18	6.0	4.9	8	3	6.8			E250M8NO1		
8	1.25	90	18	8.0	6.2	9	3	6.8	35	E200M8NO1			
10	1.50	100	20	10.0	8.0	11	3	8.5	39	E200M10		E237M10	
10	1.50	100	20	7.0	5.5	8	3	8.5			E250M10		
10	1.50	100	20	10.0	8.0	11	3	8.5	39	E200M10NO1			
12	1.75	110	23	9.0	7.0	10	3	10.3			E250M12		
12	1.75	110	23	9.0	7.0	10	4	10.3					E251M12

NO1 - NO9



M	P mm	l ₁ mm	l ₂ mm	d ₂ ∅ mm	□ a mm	l ₃ mm	z		l ₄ mm	E200	E250	E237	E251
12	1.75	110	23	9.0	7.0	10	3	10.3			E250M12NO1		
14	2.00	110	25	11.0	9.0	12	3	12.0			E250M14		
14	2.00	110	25	11.0	9.0	12	4	12.0					E251M14
14	2.00	110	25	11.0	9.0	12	3	12.0			E250M14NO1		
16	2.00	110	25	12.0	9.0	12	3	14.0			E250M16		
16	2.00	110	25	12.0	9.0	12	4	14.0					E251M16
16	2.00	110	25	12.0	9.0	12	3	14.0			E250M16NO1		
18	2.50	125	30	14.0	11.0	14	3	15.5			E250M18	 NO1 - NO9 219	
18	2.50	125	30	14.0	11.0	14	4	15.5					E251M18
18	2.50	125	30	14.0	11.0	14	3	15.5			E250M18NO1		
20	2.50	140	30	16.0	12.0	15	3	17.5			E250M20		
20	2.50	140	30	16.0	12.0	15	4	17.5					E251M20
20	2.50	140	30	16.0	12.0	15	3	17.5			E250M20NO1		
22	2.50	140	34	18.0	14.5	17	4	19.5			E250M22		E251M22
22	2.50	140	34	18.0	14.5	17	4	19.5			E250M22NO1		
24	3.00	160	38	18.0	14.5	17	4	21.0			E250M24		E251M24
27	3.00	160	38	20.0	16.0	19	4	24.0			E250M27		
30	3.50	180	45	22.0	18.0	21	4	26.5			E250M30		
33	3.50	180	50	25.0	20.0	23	4	29.5			E250M33		
36	4.00	200	55	28.0	22.0	25	4	32.0			E250M36		
39	4.00	200	60	32.0	24.0	27	4	35.0			E250M39		
42	4.50	200	60	32.0	24.0	27	4	37.5			E250M42	¹⁾	
45	4.50	220	65	36.0	29.0	32	6	40.5			E250M45	¹⁾	
48	5.00	250	70	36.0	29.0	32	6	43.0			E250M48	¹⁾	
52	5.00	250	70	40.0	32.0	35	6	47.0			E250M52	¹⁾	

E201

- M strojní závitník, bílý Shark

Do vyprodání skladu dodáváno v HSS-E

E252

- M Машинный метчик с прямой стружечной канавкой, White Shark

HSS-E до складирования новой продукции

E390

- M Gwintownik maszynowy metryczny z prostym rowkiem wiórowym, Biały Shark

Do wyczerpania obecnych zapasów magazynowych dostepny ze stali HSS-E

- M strojový závitník, bílý Shark

Do vypredania skladu dodávané v HSS-E

E201; E252; E390	▪	3.1	3.2	3.3	8.2
	•	3.4	6.2	6.4	7.4

E201	M	DIN 371	6HX		2XD	HSS-E PM	C 2-3			ST	
E252	M	DIN 376	6HX		2XD	HSS-E PM	C 2-3			ST	
E390	M	DIN 371<10 376>12	6HX		2XD	HSS-E PM	C 2-3			TiAIN	

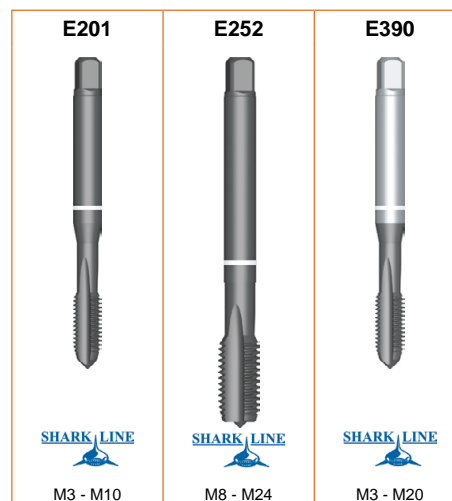
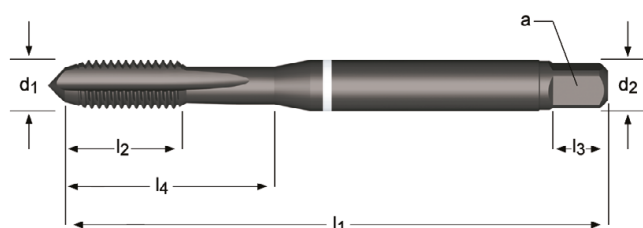

M	P mm	l ₁ mm	l ₂ mm	d ₂ ∅ mm	a mm	l ₃ mm	z		l ₄ mm	E201	E252	E390
3	0.50	56	9	3.5	2.7	6	3	2.5	18	E201M3		E390M3
4	0.70	63	12	4.5	3.4	6	4	3.3	21	E201M4		E390M4
5	0.80	70	13	6.0	4.9	8	4	4.2	25	E201M5		E390M5
6	1.00	80	15	6.0	4.9	8	4	5.0	30	E201M6		E390M6
8	1.25	90	18	6.0	4.9	8	4	6.8			E252M8	
8	1.25	90	18	8.0	6.2	9	4	6.8	35	E201M8		E390M8
10	1.50	100	20	10.0	8.0	11	4	8.5	39	E201M10		E390M10
10	1.50	100	20	7.0	5.5	8	4	8.5			E252M10	
12	1.75	110	23	9.0	7.0	10	4	10.3			E252M12	E390M12
14	2.00	110	25	11.0	9.0	12	4	12.0			E252M14	
16	2.00	110	25	12.0	9.0	12	4	14.0			E252M16	E390M16
18	2.50	125	30	14.0	11.0	14	4	15.5			E252M18	
20	2.50	140	30	16.0	12.0	15	4	17.5			E252M20	E390M20
22	2.50	140	34	18.0	14.5	17	4	19.5			E252M22	
24	3.00	160	38	18.0	14.5	17	4	21.0			E252M24	

- E500** • M strojní závitník
E501 • M Машинные метчики с прямой стружечной канавкой
E504 • M Gwintownik maszynowy, prosty rowek wiórowy
 • M strojový závitník

E500; E501	•	1.1	1.2	1.3	1.4	1.5	3.1	3.2	3.3	3.4	6.1	6.2	6.3	6.4	7.2	7.3	7.4	8.2	8.3
E504	▪	3.1	3.2	3.3															
	•	1.1	1.2	1.3	1.4	1.5	3.4	6.2	6.3	6.4	7.2	7.3	7.4	8.2	8.3				

E500	M	ISO 529	6H		1.5XD	HSS					
E501	M	ISO 529	6H		1.5XD	HSS					
E504	M	ISO 529	6H		1.5XD	HSS				TiN	

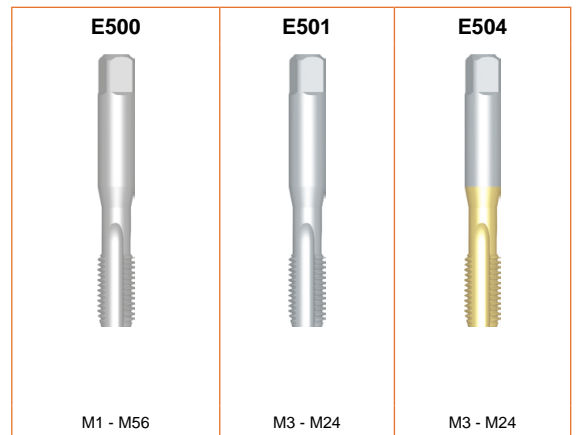
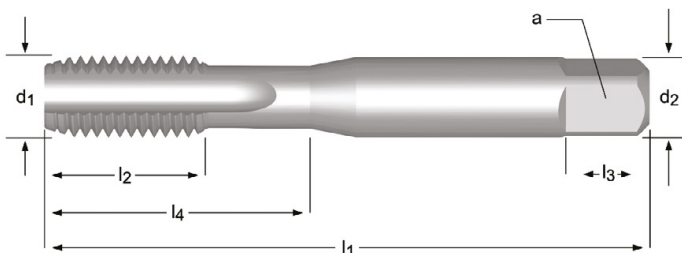



M	P mm	l ₁ mm	l ₂ mm	d ₂ Ø mm	∅ a mm	l ₃ mm	z		l ₄ mm	E500	E501	E504
1	0.25	38	4.5	2.50	2.00	4	2	0.75	4.5	E500M1NO1	¹⁾	
1	0.25	38	4.5	2.50	2.00	4	2	0.75	4.5	E500M1NO2	¹⁾	
1	0.25	38	4.5	2.50	2.00	4	2	0.75	4.5	E500M1NO3	¹⁾	
1.2	0.25	38	4.5	2.50	2.00	4	2	0.95	4.5	E500M1.2NO1	¹⁾	
1.2	0.25	38	4.5	2.50	2.00	4	2	0.95	4.5	E500M1.2NO2	¹⁾	
1.2	0.25	38	4.5	2.50	2.00	4	2	0.95	4.5	E500M1.2NO3	¹⁾	
1.4	0.30	40	6	2.50	2.00	4	2	1.1	6	E500M1.4NO1	¹⁾	
1.4	0.30	40	6	2.50	2.00	4	2	1.1	6	E500M1.4NO2	¹⁾	
1.4	0.30	40	6	2.50	2.00	4	2	1.1	6	E500M1.4NO3	¹⁾	
1.6	0.35	41	8	2.50	2.00	4	2	1.25	8	E500M1.6NO1		
1.6	0.35	41	8	2.50	2.00	4	2	1.25	8	E500M1.6NO2		
1.6	0.35	41	8	2.50	2.00	4	2	1.25	8	E500M1.6NO3	NO1 - NO9	
1.6	0.35	41	8	2.50	2.00	4	2	1.25	8	E500M1.6NO6		
1.7	0.35	41	8	2.50	2.00	4	2	1.35	8	E500M1.7NO1		
1.7	0.35	41	8	2.50	2.00	4	2	1.35	8	E500M1.7NO2		
1.7	0.35	41	8	2.50	2.00	4	2	1.35	8	E500M1.7NO3		
1.7	0.35	41	8	2.50	2.00	4	2	1.35	8	E500M1.7NO6		
1.7	0.35	41	8	2.50	2.00	4	2	1.35	8	E500M1.7NO8		

¹⁾ 5H

M	P mm	l ₁ mm	l ₂ mm	d ₂ ∅ mm	∠ a mm	l ₃ mm	z		l ₄ mm	E500	E501	E504
1.8	0.35	41	8	2.50	2.00	4	2	1.45	8	E500M1.8NO1		
1.8	0.35	41	8	2.50	2.00	4	2	1.45	8	E500M1.8NO2		
1.8	0.35	41	8	2.50	2.00	4	2	1.45	8	E500M1.8NO3		
2	0.40	41	8	2.50	2.00	4	3	1.6	8	E500M2NO1		
2	0.45	41	8	2.50	2.00	4	3	1.55	8	E500M2X.45NO1		
2	0.40	41	8	2.50	2.00	4	3	1.6	8	E500M2NO2		
2	0.45	41	8	2.50	2.00	4	3	1.55	8	E500M2X.45NO2		
2	0.40	41	8	2.50	2.00	4	3	1.6	8	E500M2NO3		
2	0.45	41	8	2.50	2.00	4	3	1.55	8	E500M2X.45NO3		
2	0.40	41	8	2.50	2.00	4	3	1.6	8	E500M2NO6		
2	0.40	41	8	2.50	2.00	4	3	1.6	8	E500M2NO8		
2.2	0.45	44.5	9.5	2.80	2.24	5	3	1.75	9.5	E500M2.2NO1		
2.2	0.45	44.5	9.5	2.80	2.24	5	3	1.75	9.5	E500M2.2NO2		
2.2	0.45	44.5	9.5	2.80	2.24	5	3	1.75	9.5	E500M2.2NO3		
2.3	0.45	44.5	9.5	2.80	2.24	5	3	1.85	9.5	E500M2.3NO1		
2.3	0.45	44.5	9.5	2.80	2.24	5	3	1.85	9.5	E500M2.3NO2		
2.3	0.45	44.5	9.5	2.80	2.24	5	3	1.85	9.5	E500M2.3NO3		
2.5	0.45	44.5	9.5	2.80	2.24	5	3	2.05	9.5	E500M2.5NO1		
2.5	0.45	44.5	9.5	2.80	2.24	5	3	2.05	9.5	E500M2.5NO2		
2.5	0.45	44.5	9.5	2.80	2.24	5	3	2.05	9.5	E500M2.5NO3		
2.5	0.45	44.5	9.5	2.80	2.24	5	3	2.05	9.5	E500M2.5NO6		
2.5	0.45	44.5	9.5	2.80	2.24	5	3	2.05	9.5	E500M2.5NO8		
2.6	0.45	44.5	9.5	2.80	2.24	5	3	2.15	9.5	E500M2.6NO1		
2.6	0.45	44.5	9.5	2.80	2.24	5	3	2.15	9.5	E500M2.6NO2		
2.6	0.45	44.5	9.5	2.80	2.24	5	3	2.15	9.5	E500M2.6NO3		
3	0.50	48	12.5	3.15	2.50	5	3	2.5	12.5	E500M3NO1	E501M3NO1	
3	0.60	48	12.5	3.15	2.50	5	3	2.4	12.5	E500M3X.6NO1		
3	0.50	48	12.5	3.15	2.50	5	3	2.5	12.5	E500M3NO2	E501M3NO2	
3	0.60	48	12.5	3.15	2.50	5	3	2.4	12.5	E500M3X.6NO2		
3	0.50	48	12.5	3.15	2.50	5	3	2.5	12.5	E500M3NO3	E501M3NO3	E504M3NO3
3	0.60	48	12.5	3.15	2.50	5	3	2.4	12.5	E500M3X.6NO3		
3	0.50	48	12.5	3.15	2.50	5	3	2.5	12.5	E500M3NO6		
3	0.50	48	12.5	3.15	2.50	5	3	2.5	12.5	E500M3NO7		
3	0.50	48	12.5	3.15	2.50	5	3	2.5	12.5	E500M3NO8		
3.5	0.60	50	14	3.55	2.80	5	3	2.9	14	E500M3.5NO1		
3.5	0.60	50	14	3.55	2.80	5	3	2.9	14	E500M3.5NO2		
3.5	0.60	50	14	3.55	2.80	5	3	2.9	14	E500M3.5NO3		
3.5	0.60	50	14	3.55	2.80	5	3	2.9	14	E500M3.5NO6		
4	0.70	53	14	4.00	3.15	6	3	3.3	14	E500M4NO1	E501M4NO1	
4	0.75	53	14	4.00	3.15	6	3	3.25	14	E500M4X.75NO1		
4	0.70	53	14	4.00	3.15	6	3	3.3	14	E500M4NO2	E501M4NO2	
4	0.75	53	14	4.00	3.15	6	3	3.25	14	E500M4X.75NO2		
4	0.70	53	14	4.00	3.15	6	3	3.3	14	E500M4NO3	E501M4NO3	E504M4NO3
4	0.75	53	14	4.00	3.15	6	3	3.25	14	E500M4X.75NO3		
4	0.70	53	14	4.00	3.15	6	3	3.3	14	E500M4NO6		
4	0.70	53	14	4.00	3.15	6	3	3.3	14	E500M4NO7		
4	0.70	53	14	4.00	3.15	6	3	3.3	14	E500M4NO8		
4.5	0.75	53	9.5	4.50	3.55	6	3	3.8	18	E500M4.5NO1		
4.5	0.75	53	9.5	4.50	3.55	6	3	3.8	18	E500M4.5NO2		
4.5	0.75	53	9.5	4.50	3.55	6	3	3.8	18	E500M4.5NO3		
4.5	0.75	53	9.5	4.50	3.55	6	3	3.8	18	E500M4.5NO6		
5	0.80	58	11	5.00	4.00	7	3	4.2	22	E500M5NO1		
5	0.90	58	11	5.00	4.00	7	3	4.1	22	E500M5X.9NO1		
5	0.80	58	11	5.00	4.00	7	3	4.2	22	E500M5NO2	E501M5NO2	
5	0.90	58	11	5.00	4.00	7	3	4.1	22	E500M5X.9NO2		
5	0.80	58	11	5.00	4.00	7	3	4.2	22	E500M5NO3	E501M5NO3	E504M5NO3
5	0.90	58	11	5.00	4.00	7	3	4.1	22	E500M5X.9NO3		
5	0.80	58	11	5.00	4.00	7	3	4.2	22	E500M5NO6		
5	0.80	58	11	5.00	4.00	7	3	4.2	22	E500M5NO7		
5	0.80	58	11	5.00	4.00	7	3	4.2	22	E500M5NO8		
5.5	0.90	62	12	5.60	4.50	7	3	4.6	21	E500M5.5X.9NO1		
5.5	0.90	62	12	5.60	4.50	7	3	4.6	21	E500M5.5X.9NO2		
5.5	0.90	62	12	5.60	4.50	7	3	4.6	21	E500M5.5X.9NO3		
6	1.00	66	13	6.30	5.00	8	3	5	26	E500M6NO1	E501M6NO1	
6	1.00	66	13	6.30	5.00	8	3	5	26	E500M6NO2	E501M6NO2	
6	1.00	66	13	6.30	5.00	8	3	5	26	E500M6NO3	E501M6NO3	E504M6NO3
6	1.00	66	13	6.30	5.00	8	3	5	26	E500M6NO6		
6	1.00	66	13	6.30	5.00	8	3	5	26	E500M6NO7		
6	1.00	66	13	6.30	5.00	8	3	5	26	E500M6NO8		
7	1.00	66	13	7.10	5.60	8	3	6	26	E500M7NO1		



M	P mm	l ₁ mm	l ₂ mm	d ₂ ∅ mm	∅ a mm	l ₃ mm	z		l ₄ mm	E500	E501	E504
7	1.00	66	13	7.10	5.60	8	3	6	26	E500M7NO2		
7	1.00	66	13	7.10	5.60	8	3	6	26	E500M7NO3		
7	1.00	66	13	7.10	5.60	8	3	6	26	E500M7NO6		
8	1.25	72	16	8.00	6.30	9	3	6.8	29	E500M8NO1	E501M8NO1	
8	1.25	72	16	8.00	6.30	9	3	6.8	29	E500M8NO2	E501M8NO2	
8	1.25	72	16	8.00	6.30	9	3	6.8	29	E500M8NO3	E501M8NO3	E504M8NO3
8	1.25	72	16	8.00	6.30	9	3	6.8	29	E500M8NO6		
8	1.25	72	16	8.00	6.30	9	3	6.8	29	E500M8NO7		
8	1.25	72	16	8.00	6.30	9	3	6.8	29	E500M8NO8		
9	1.25	72	16	9.00	7.10	10	3	7.8	29	E500M9NO1		
9	1.25	72	16	9.00	7.10	10	3	7.8	29	E500M9NO2		
9	1.25	72	16	9.00	7.10	10	3	7.8	29	E500M9NO3		
9	1.25	72	16	9.00	7.10	10	3	7.8	29	E500M9NO6		
10	1.50	80	18	10.00	8.00	11	3	8.5	34	E500M10NO1	E501M10NO1	
10	1.50	80	18	10.00	8.00	11	3	8.5	34	E500M10NO2	E501M10NO2	
10	1.50	80	18	10.00	8.00	11	3	8.5	34	E500M10NO3	E501M10NO3	E504M10NO3
10	1.50	80	18	10.00	8.00	11	3	8.5	34	E500M10NO6		
10	1.50	80	18	10.00	8.00	11	3	8.5	34	E500M10NO7		
10	1.50	80	18	10.00	8.00	11	3	8.5	34	E500M10NO8		
11	1.50	85	19	8.00	6.30	9	3	9.5	-	E500M11NO1	 NO1 - NO9 219	
11	1.50	85	19	8.00	6.30	9	3	9.5	-	E500M11NO2		
11	1.50	85	19	8.00	6.30	9	3	9.5	-	E500M11NO3		
11	1.50	85	19	8.00	6.30	9	3	9.5	-	E500M11NO6		
12	1.75	89	22	9.00	7.10	10	3	10.3	-	E500M12NO1	E501M12NO1	
12	1.75	89	22	9.00	7.10	10	3	10.3	-	E500M12NO2	E501M12NO2	
12	1.75	89	22	9.00	7.10	10	3	10.3	-	E500M12NO3	E501M12NO3	
12	1.75	89	22	9.00	7.10	10	3	10.3	-	E500M12NO6		
12	1.75	89	22	9.00	7.10	10	3	10.3	-	E500M12NO7		
12	1.75	89	22	9.00	7.10	10	3	10.3	-	E500M12NO8		
14	2.00	95	24	11.20	9.00	12	4	12	-	E500M14NO1	E501M14NO1	
14	2.00	95	24	11.20	9.00	12	4	12	-	E500M14NO2	E501M14NO2	
14	2.00	95	24	11.20	9.00	12	4	12	-	E500M14NO3	E501M14NO3	
14	2.00	95	24	11.20	9.00	12	4	12	-	E500M14NO6		
14	2.00	95	24	11.20	9.00	12	4	12	-	E500M14NO7		
14	2.00	95	24	11.20	9.00	12	4	12	-	E500M14NO8		
16	2.00	102	24	12.50	10.00	13	4	14	-	E500M16NO1	E501M16NO1	
16	2.00	102	24	12.50	10.00	13	4	14	-	E500M16NO2	E501M16NO2	
16	2.00	102	24	12.50	10.00	13	4	14	-	E500M16NO3	E501M16NO3	
16	2.00	102	24	12.50	10.00	13	4	14	-	E500M16NO6		
16	2.00	102	24	12.50	10.00	13	4	14	-	E500M16NO7		
16	2.00	102	24	12.50	10.00	13	4	14	-	E500M16NO8		
18	2.50	112	29	14.00	11.20	14	4	15.5	-	E500M18NO1		
18	2.50	112	29	14.00	11.20	14	4	15.5	-	E500M18NO2		
18	2.50	112	29	14.00	11.20	14	4	15.5	-	E500M18NO3	E501M18NO3	
18	2.50	112	29	14.00	11.20	14	4	15.5	-	E500M18NO6		
20	2.50	112	29	14.00	11.20	14	4	17.5	-	E500M20NO1	E501M20NO1	
20	2.50	112	29	14.00	11.20	14	4	17.5	-	E500M20NO2	E501M20NO2	
20	2.50	112	29	14.00	11.20	14	4	17.5	-	E500M20NO3	E501M20NO3	
20	2.50	112	29	14.00	11.20	14	4	17.5	-	E500M20NO6		
20	2.50	112	29	14.00	11.20	14	4	17.5	-	E500M20NO7		
20	2.50	112	29	14.00	11.20	14	4	17.5	-	E500M20NO8		
22	2.50	118	29	16.00	12.50	16	4	19.5	-	E500M22NO1		
22	2.50	118	29	16.00	12.50	16	4	19.5	-	E500M22NO2		
22	2.50	118	29	16.00	12.50	16	4	19.5	-	E500M22NO3	E501M22NO3	
22	2.50	118	29	16.00	12.50	16	4	19.5	-	E500M22NO6		
24	3.00	130	35	18.00	14.00	18	4	21	-	E500M24NO1		
24	3.00	130	35	18.00	14.00	18	4	21	-	E500M24NO2	E501M24NO2	
24	3.00	130	35	18.00	14.00	18	4	21	-	E500M24NO3	E501M24NO3	
24	3.00	130	35	18.00	14.00	18	4	21	-	E500M24NO6		
24	3.00	130	35	18.00	14.00	18	4	21	-	E500M24NO7		
27	3.00	135	35	20.00	16.00	20	4	24	-	E500M27NO1		
27	3.00	135	35	20.00	16.00	20	4	24	-	E500M27NO2		
27	3.00	135	35	20.00	16.00	20	4	24	-	E500M27NO3		
30	3.50	138	41	20.00	16.00	20	4	26.5	-	E500M30NO1		
30	3.50	138	41	20.00	16.00	20	4	26.5	-	E500M30NO2		
30	3.50	138	41	20.00	16.00	20	4	26.5	-	E500M30NO3		
33	3.50	151	41	22.40	18.00	22	4	29.5	-	E500M33NO1		
33	3.50	151	41	22.40	18.00	22	4	29.5	-	E500M33NO2		
33	3.50	151	41	22.40	18.00	22	4	29.5	-	E500M33NO3		
36	4.00	162	47	25.00	20.00	24	4	32	-	E500M36NO1		

M	P mm	l ₁ mm	l ₂ mm	d ₂ ∅ mm	∠ a mm	l ₃ mm	z		l ₄ mm	E500	E501	E504
36	4.00	162	47	25.00	20.00	24	4	32	-	E500M36NO2		
36	4.00	162	47	25.00	20.00	24	4	32	-	E500M36NO3		
39	4.00	170	47	28.00	22.40	26	4	35	-	E500M39NO1		
39	4.00	170	47	28.00	22.40	26	4	35	-	E500M39NO2		
39	4.00	170	47	28.00	22.40	26	4	35	-	E500M39NO3		
42	4.50	170	53	28.00	22.40	26	6	37.5	-	E500M42NO1		
42	4.50	170	53	28.00	22.40	26	6	37.5	-	E500M42NO2		
42	4.50	170	53	28.00	22.40	26	6	37.5	-	E500M42NO3		
45	4.50	187	54	31.50	25.00	28	6	40.5	-	E500M45NO1		
45	4.50	187	54	31.50	25.00	28	6	40.5	-	E500M45NO2		
45	4.50	187	54	31.50	25.00	28	6	40.5	-	E500M45NO3		
48	5.00	187	60	31.50	25.00	28	6	43	-	E500M48NO1		
48	5.00	187	60	31.50	25.00	28	6	43	-	E500M48NO2		
48	5.00	187	60	31.50	25.00	28	6	43	-	E500M48NO3		
52	5.00	200	60	35.50	28.00	31	6	47	-	E500M52NO3		
56	5.50	200	60	35.50	28.00	31	6	50.5	-	E500M56NO3		

N01 - N09



219

- E303**
- M strojní závitník
 - M Машинные метчики с прямой стружечной канавкой
 - M Gwintownik maszynowy, prosty rowek wiórowy
 - M strojový závitník

E303 • 1.1 1.2 1.3 1.4 1.5 3.1 3.2 3.3 6.2 6.3 7.2 7.3 8.2

E303 M DIN 357 6H 2XD HSS-E D18-20 C 2-3

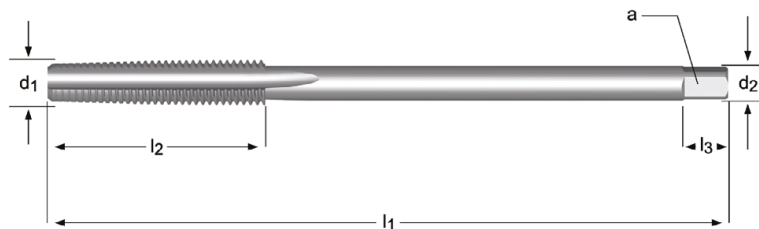

M	P mm	l ₁ mm	l ₂ mm	d ₂ Ø mm	∠ a mm	l ₃ mm	z	↔	E303
3	0.50	70	22	2.2	2.1	5	3	2.5	E303M3NO1
3	0.50	70	22	2.2	2.1	5	3	2.5	E303M3NO3
4	0.70	90	25	2.8	2.1	5	3	3.3	E303M4NO1
4	0.70	90	25	2.8	2.1	5	3	3.3	E303M4NO3
5	0.80	100	28	3.5	2.7	6	3	4.2	E303M5NO1
5	0.80	100	28	3.5	2.7	6	3	4.2	E303M5NO3
6	1.00	110	32	4.5	3.4	6	3	5.0	E303M6NO1
6	1.00	110	32	4.5	3.4	6	3	5.0	E303M6NO3
8	1.25	125	40	6.0	4.9	8	3	6.8	E303M8NO1
8	1.25	125	40	6.0	4.9	8	3	6.8	E303M8NO3
10	1.50	140	45	7.0	5.5	8	3	8.5	E303M10NO1
10	1.50	140	45	7.0	5.5	8	3	8.5	E303M10NO3
12	1.75	180	50	9.0	7.0	10	3	10.3	E303M12NO1
12	1.75	180	50	9.0	7.0	10	3	10.3	E303M12NO3
14	2.00	200	56	11.0	9.0	12	3	12.0	E303M14NO1
14	2.00	200	56	11.0	9.0	12	3	12.0	E303M14NO3
16	2.00	200	63	12.0	9.0	12	3	14.0	E303M16NO1
16	2.00	200	63	12.0	9.0	12	3	14.0	E303M16NO3
20	2.50	250	70	16.0	12.0	15	3	17.5	E303M20NO1
20	2.50	250	70	16.0	12.0	15	3	17.5	E303M20NO3

NO1 - NO9
219

E600

- M strojní závitník, extra dlouhý
- M Машинные метчики, сверхдлинные с прямой стружечной канавкой

Do vyprodání skladu dodáváno v HSS-E

E610

- M Gwintownik maszynowy, bardzo długi, prosty rowek wiórowy
- M závitník strojový, extra dlhý

HSS-E do skladování nové produkce

Do wyczerpania obecnych zapasów magazynowych dostepny ze stali HSS-E

Do vyprodania skladu dodavane v HSS-E

E600	•	1.1	1.2	1.3	1.4	1.5	3.1	3.2	3.3	3.4	6.1	6.2	6.3	6.4	7.2	7.3	7.4	8.2	8.3
E610	▪	3.1	3.2	3.3															
	•	1.1	1.2	1.3	1.4	1.5	3.4	6.2	6.3	6.4	7.2	7.3	7.4	8.2	8.3				

E600	M	ISO 2283	6H		1.5XD	HSS-E PM	C 2-3			
E610	M	ISO 2283	6H		1.5XD	HSS-E PM	C 2-3			

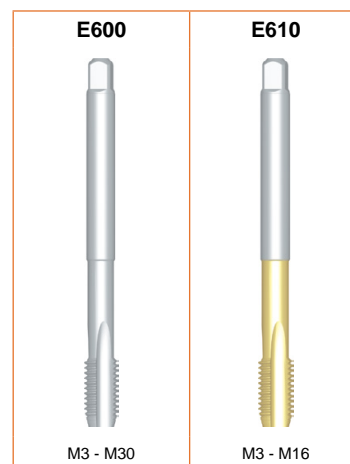
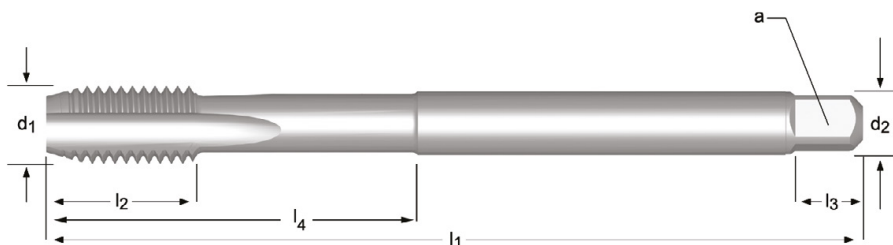

M	P mm	l ₁ mm	l ₂ mm	d ₂ mm	∠ a mm	l ₃ mm	z		l ₄ mm	E600	E610
3	0.50	66	9	3.15	2.50	5	3	2.5	18	E600M3NO3	E610M3NO3
4	0.70	73	12	3.15	2.50	5	3	3.3	-	E600M4NO1	
4	0.70	73	12	3.15	2.50	5	3	3.3	-	E600M4NO2	
4	0.70	73	12	3.15	2.50	5	3	3.3	-	E600M4NO3	E610M4NO3
5	0.80	79	12	4.00	3.15	6	3	4.2	-	E600M5NO1	
5	0.80	79	12	4.00	3.15	6	3	4.2	-	E600M5NO2	
5	0.80	79	12	4.00	3.15	6	3	4.2	-	E600M5NO3	E610M5NO3
6	1.00	89	14	4.50	3.55	6	3	5	-	E600M6NO1	
6	1.00	89	14	4.50	3.55	6	3	5	-	E600M6NO2	
6	1.00	89	14	4.50	3.55	6	3	5	-	E600M6NO3	E610M6NO3
8	1.25	97	17	6.30	5.00	8	3	6.8	-	E600M8NO1	
8	1.25	97	17	6.30	5.00	8	3	6.8	-	E600M8NO2	
8	1.25	97	17	6.30	5.00	8	3	6.8	-	E600M8NO3	E610M8NO3
10	1.50	108	19	8.00	6.30	9	3	8.5	-	E600M10NO1	
10	1.50	108	19	8.00	6.30	9	3	8.5	-	E600M10NO2	
10	1.50	108	19	8.00	6.30	9	3	8.5	-	E600M10NO3	E610M10NO3
12	1.75	119	23	9.00	7.10	10	3	10.3	-	E600M12NO1	
12	1.75	119	23	9.00	7.10	10	3	10.3	-	E600M12NO2	
12	1.75	119	23	9.00	7.10	10	3	10.3	-	E600M12NO3	E610M12NO3
16	2.00	137	25	12.50	10.0	13	4	14	-	E600M16NO3	E610M16NO3
20	2.50	149	30	14.00	11.2	14	4	17.5	-	E600M20NO3	



EP006H
EP006G
EP00TiN
EP016H

- M strojní závitník, přímá drážka, lamač Do vyprodání skladu dodáváno v HSS-E
- M Машинные метчики с подточкой по заборному конусу Поддерживается в HSS-E до складирования новой продукции
- M Gwintownik maszynowy prosty Do wyczerpania obecnych zapasów magazynowych dostepny ze stali HSS-E
- M strojový závitník, priama drážka s lamačom triesok Do vypredania skladu dodávané v HSS-E

EP006H; EP006G	▪	1.1	1.2	1.3	1.4	1.5	6.1	6.3	7.1	7.2	7.3	7.4
	•	1.6	3.1	3.2	3.3	3.4	4.1	4.2	5.1	5.2	6.2	8.1
EP00TiN	▪	1.1	1.2	1.3	1.4	1.5	2.1	2.2	6.1	6.3	7.3	7.4
	•	1.6	2.3	3.1	3.2	3.3	3.4	4.1	4.2	5.1	5.2	6.2
EP016H	▪	1.1	1.2	1.3	1.4	1.5						
	•	1.6	2.1	2.2	2.3	3.1	3.2	3.3	3.4			

EP006H	M	DIN 371≤10 376≥12	6H		2.5XD	HSS-E PM	B 3.5-5				L001 337	L114 334
EP006G	M	DIN 371≤10 376≥12	6G		2.5XD	HSS-E PM	B 3.5-5					
EP00TiN	M	DIN 371≤10 376≥12	6H		2.5XD	HSS-E PM	B 3.5-5				TiN	
EP016H	M	DIN 371≤10 376≥12	6H		2.5XD	HSS-E PM	B 3.5-5				ST	

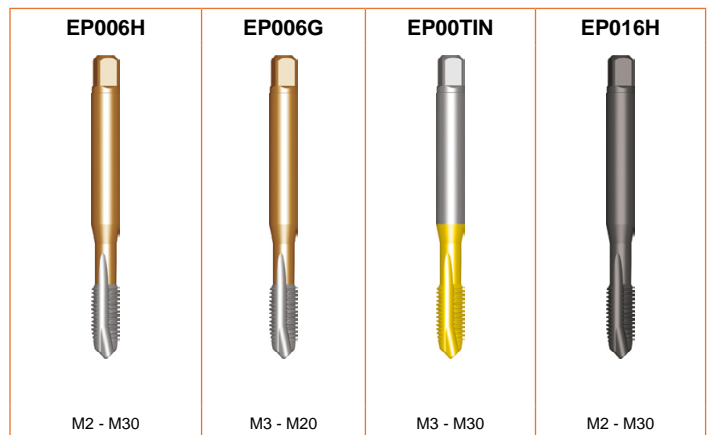
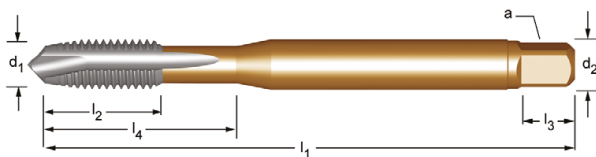

M	P mm	l ₁ mm	l ₂ mm	d ₂ ∅ mm	∠ a mm	l ₃ mm	z		l ₄ mm	EP006H	EP006G	EP00TiN	EP016H
2	0.40	50	6	2.8	2.1	5	2	1.6	9	EP00M2			EP01M2
2.5	0.45	50	8	2.8	2.1	5	2	2.1	12.5	EP00M2.5			EP01M2.5
3	0.50	56	10	2.2	1.8	4	3	2.5	18	EP00M3DIN376			EP01M3DIN376
3	0.50	56	9	3.5	2.7	6	3	2.5	18	EP00M3	EP006GM3	EP00TiNM3	EP01M3
3.5	0.60	56	11	4.0	3.0	6	3	2.9	20	EP00M3.5			EP01M3.5
4	0.70	63	12	2.8	2.1	5	3	3.3	21	EP00M4DIN376			EP01M4DIN376
4	0.70	63	12	4.5	3.4	6	3	3.3	21	EP00M4	EP006GM4	EP00TiNM4	EP01M4
4.5	0.75	70	13	6.0	4.9	8	3	3.8	25	EP00M4.5			EP01M4.5
5	0.80	70	13	3.5	2.7	6	3	4.2	25	EP00M5DIN376			EP01M5DIN376
5	0.80	70	13	6.0	4.9	8	3	4.2	25	EP00M5	EP006GM5	EP00TiNM5	EP01M5
6	1.00	80	15	4.5	3.4	6	3	5	30	EP00M6DIN376			EP01M6DIN376
6	1.00	80	15	6.0	4.9	8	3	5	30	EP00M6	EP006GM6	EP00TiNM6	EP01M6
7	1.00	80	15	7.0	5.5	8	3	6	30	EP00M7			EP01M7
8	1.25	90	18	6.0	4.9	8	3	6.8	35	EP00M8DIN376			EP01M8DIN376
8	1.25	90	18	8.0	6.2	9	3	6.8	35	EP00M8	EP006GM8	EP00TiNM8	EP01M8
10	1.50	100	20	10.0	8.0	11	3	8.5	39	EP00M10	EP006GM10	EP00TiNM10	EP01M10

M	P mm	l ₁ mm	l ₂ mm	d ₂ ∅ mm	□ a mm	l ₃ mm	z	 mm	l ₄ mm	EP006H	EP006G	EP00TIN	EP016H
10	1.50	100	20	7.0	5.5	8	3	8.5	-	EP00M10DIN376			EP01M10DIN376
12	1.75	110	23	9.0	7.0	10	3	10.3	-	EP00M12	EP006GM12	EP00TINM12	EP01M12
14	2.00	110	25	11.0	9.0	12	3	12	-	EP00M14		EP00TINM14	EP01M14
16	2.00	110	25	12.0	9.0	12	3	14	-	EP00M16	EP006GM16	EP00TINM16	EP01M16
18	2.50	125	30	14.0	11.0	14	4	15.5	-	EP00M18		EP00TINM18	EP01M18
20	2.50	140	30	16.0	12.0	15	4	17.5	-	EP00M20	EP006GM20	EP00TINM20	EP01M20
22	2.50	140	34	18.0	14.5	17	4	19.5	-	EP00M22		EP00TINM22	EP01M22
24	3.00	160	38	18.0	14.5	17	4	21	-	EP00M24		EP00TINM24	EP01M24
27	3.00	160	38	20.0	16.0	19	4	24	-	EP00M27		EP00TINM27	EP01M27
30	3.50	180	45	22.0	18.0	21	4	26.5	-	EP00M30		EP00TINM30	EP01M30

- E297**
- M strojní závitník s lamačem, žlutý Shark
 - M Машинный метчик с подточкой по заборному конусу, Yellow Shark
 - M Gwintownik maszynowy metryczny ze skośną powierzchnią natarcia, żółty Shark
 - M strojový závitník s lamačom, žltý Shark

E297 ■ 1.1 1.2 1.3 6.1 6.3
 • 1.4 1.5 6.2

E297 M 6H HSS-E PM

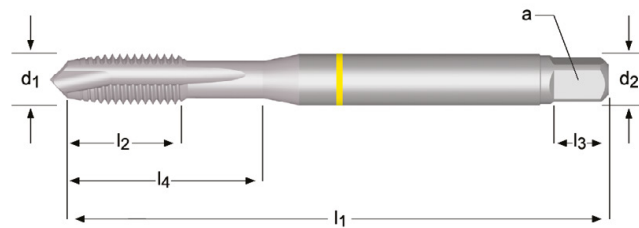

M	P mm	l ₁ mm	l ₂ mm	d ₂ ∅ mm	∠ a mm	l ₃ mm	z		l ₄ mm	E297
3	0.50	56	9	3.5	2.7	6	3	2.5	18	E297M3
4	0.70	63	12	4.5	3.4	6	3	3.3	21	E297M4
5	0.80	70	13	6.0	4.9	8	3	4.2	25	E297M5
6	1.00	80	15	6.0	4.9	8	3	5.0	30	E297M6
8	1.25	90	18	8.0	6.2	9	3	6.8	35	E297M8
10	1.50	100	20	10.0	8.0	11	3	8.5	39	E297M10
12	1.75	110	23	9.0	7.0	10	3	10.3	-	E297M12
14	2.00	110	25	11.0	9.0	12	3	12.0	-	E297M14
16	2.00	110	25	12.0	9.0	12	3	14.0	-	E297M16
18	2.50	125	30	14.0	11.0	14	3	15.5	-	E297M18
20	2.50	140	30	16.0	12.0	15	3	17.5	-	E297M20
22	2.50	140	34	18.0	14.5	17	4	19.5	-	E297M22
24	3.00	160	38	18.0	14.5	17	4	21.0	-	E297M24
27	3.00	160	38	20.0	16.0	19	4	24.0	-	E297M27
30	3.50	180	45	22.0	18.0	21	4	26.5	-	E297M30

E255

- M strojní závitník s lamačem, červený Shark
- M Машинный метчик с подточкой по заборному конусу, Red Shark
- M Gwintownik maszynowy metryczny ze skośną powierzchnią natarcia, czerwony Shark
- M strojový závitník s lamačom, červený Shark

Do vyprodání skladu dodáváno v HSS-E
HSS-E до складирования новой продукции

Do wyczerpania obecnych zapasów magazynowych
dostepny ze stali HSS-E

Do vypredania skladu dodávané v HSS-E

E255	▪	1.4			
	•	1.5	1.6	4.2	5.2
E256	▪	1.4	1.5		
	•	1.6	4.2	5.2	

E255	M	DIN 371≤10 376≥12	6H		2.5XD	HSS-E PM	B 3.5-5				
E256	M	DIN 371≤10 376≥12	6H		2.5XD	HSS-E PM	B 3.5-5			TiAIN Top	

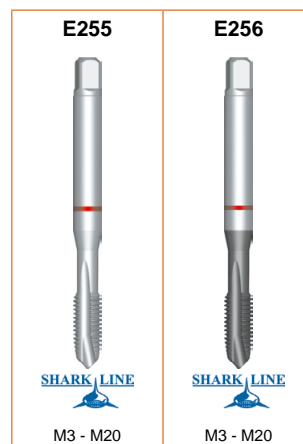
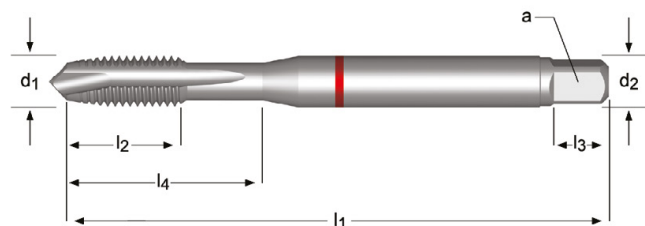

M	P mm	l ₁ mm	l ₂ mm	d ₂ ∅ mm	a mm	l ₃ mm	z		l ₄ mm	E255	E256
3	0.50	56	9	3.5	2.7	6	3	2.5	18	E255M3	E256M3
4	0.70	63	12	4.5	3.4	6	3	3.3	21	E255M4	E256M4
5	0.80	70	13	6.0	4.9	8	3	4.2	25	E255M5	E256M5
6	1.00	80	15	6.0	4.9	8	3	5.0	30	E255M6	E256M6
8	1.25	90	18	8.0	6.2	9	3	6.8	35	E255M8	E256M8
10	1.50	100	20	10.0	8.0	11	3	8.5	39	E255M10	E256M10
12	1.75	110	23	9.0	7.0	10	3	10.3	-	E255M12	E256M12
14	2.00	110	25	11.0	9.0	12	3	12.0	-	E255M14	-
16	2.00	110	25	12.0	9.0	12	3	14.0	-	E255M16	E256M16
20	2.50	140	30	16.0	12.0	15	4	17.5	-	E255M20	E256M20

- E240** • M strojní závitník s lamačem, modrý Shark
 • M Машинный метчик с подточкой по заборному конусу, Blue Shark
- E241** • M Gwintownik maszynowy metryczny ze skośną powierzchnią natarcia, niebieski Shark
 • M strojový závitník s lamačom, modrý Shark

E240	▪	2.1	2.2	2.3	
	•	1.5			
E241	▪	2.1	2.2	2.3	
	•	1.2	1.3	1.4	1.5

E240	M	DIN 371≤10 376≥12	6H		2.5XD	HSS-E PM	B 3.5-5			ST	
E241	M	DIN 371≤10 376≥12	6H		2.5XD	HSS-E PM	B 3.5-5			Super B	

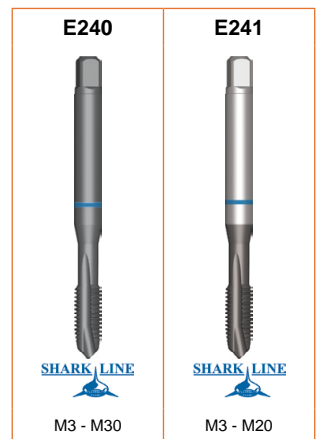
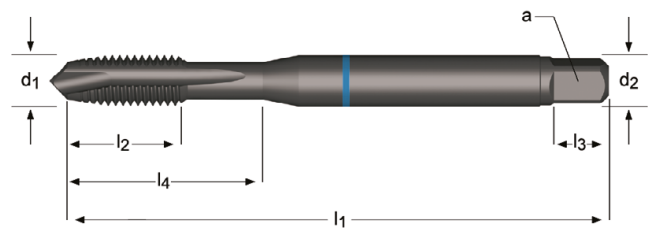

M	P mm	l ₁ mm	l ₂ mm	d ₂ ∅ mm	a mm	l ₃ mm	z		l ₄ mm	E240	E241
3	0.50	56	9	3.5	2.7	6	3	2.5	18	E240M3	E241M3
4	0.70	63	12	4.5	3.4	6	3	3.3	21	E240M4	E241M4
5	0.80	70	13	6.0	4.9	8	3	4.2	25	E240M5	E241M5
6	1.00	80	15	6.0	4.9	8	3	5.0	30	E240M6	E241M6
8	1.25	90	18	8.0	6.2	9	3	6.8	35	E240M8	E241M8
10	1.50	100	20	10.0	8.0	11	3	8.5	39	E240M10	E241M10
12	1.75	110	23	9.0	7.0	10	4	10.3	-	E240M12	E241M12
14	2.00	110	25	11.0	9.0	12	4	12.0	-	E240M14	E241M14
16	2.00	110	25	12.0	9.0	12	4	14.0	-	E240M16	E241M16
18	2.50	125	30	14.0	11.0	14	4	15.5	-	E240M18	E241M18
20	2.50	140	30	16.0	12.0	15	4	17.5	-	E240M20	E241M20
22	2.50	140	34	18.0	14.5	17	4	19.5	-	E240M22	
24	3.00	160	38	18.0	14.5	17	4	21.0	-	E240M24	
27	3.00	160	38	20.0	16.0	19	4	24.0	-	E240M27	
30	3.50	180	45	22.0	18.0	21	4	26.5	-	E240M30	

E471

- M strojní závitník s lamačem, zelený Shark
- M Машинный метчик с подточкой по заборному конусу, Green Shark
- M Gwintownik maszynowy metryczny ze skośną powierzchnią natarcia, zielony Shark
- M strojový závitník s lamačem, zelený Shark

Do vyprodání skladu dodáváno v HSS-E
HSS-E до складирования новой продукции

E472

Do wyczerpania obecnych zapasow magazynowych dostepny ze stali HSS-E

Do vypredania skladu dodávané v HSS-E

E471	▪	6.2	6.3	7.1	7.2	7.3	8.1
	•	1.1	1.2	1.3	6.1	7.4	
E472	▪	6.2	7.2	7.3	7.4		
	•	1.2	1.3	6.3	7.1	8.1	

E471	M	DIN 3715 ¹⁰ 376 ¹²	6H		2.5XD	HSS-E PM	B 3.5-5			
E472	M	DIN 3715 ¹⁰ 376 ¹²	6H		2.5XD	HSS-E PM	B 3.5-5			Super B

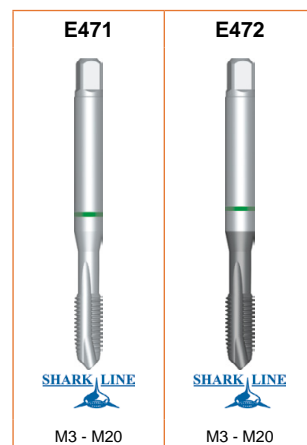
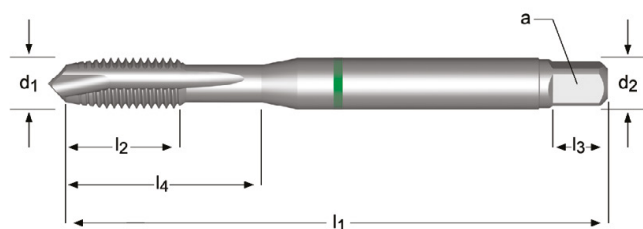

M	P mm	l ₁ mm	l ₂ mm	d ₂ ∅ mm	a mm	l ₃ mm	z		l ₄ mm	E471	E472
3	0.50	56	9	3.5	2.7	6	2	2.5	18	E471M3	E472M3
4	0.70	63	12	4.5	3.4	6	2	3.3	21	E471M4	E472M4
5	0.80	70	13	6.0	4.9	8	2	4.2	25	E471M5	E472M5
6	1.00	80	15	6.0	4.9	8	3	5.0	30	E471M6	E472M6
8	1.25	90	18	8.0	6.2	9	3	6.8	35	E471M8	E472M8
10	1.50	100	20	10.0	8.0	11	3	8.5	39	E471M10	E472M10
12	1.75	110	23	9.0	7.0	10	3	10.3	-	E471M12	E472M12
16	2.00	110	25	12.0	9.0	12	4	14.0	-	E471M16	E472M16
20	2.50	140	30	16.0	12.0	15	4	17.5	-	E471M20	E472M20

E000 E000TIN E001

- M strojní závitník, přímá drážka, lamač Do vyprodání skladu dodáváno v HSS-E
- M Машинные метчики с подточкой по заборному конусу HSS-E до складирования новой продукции
- M Gwintownik maszynowy prosty Do wyczerpania obecnych zapasów magazynowych dostepny ze stali HSS-E
- M strojový závitník, priama drážka s lamačom triesok Do vypredania skladu dodávané v HSS-E

E000	▪	1.1	1.2	1.3	1.4	1.5	6.1	6.3	7.1	7.2	7.3	7.4	
	•	1.6	3.1	3.2	3.3	3.4	4.1	4.2	5.1	5.2	6.2	8.1	
E000TIN	▪	1.1	1.2	1.3	1.4	1.5	2.1	2.2	6.1	6.3	7.3	7.4	
	•	1.6	2.3	3.1	3.2	3.3	3.4	4.1	4.2	5.1	5.2	6.2	8.2
E001	▪	1.1	1.2	1.3	1.4	1.5							
	•	1.6	2.1	2.2	2.3	3.1	3.2	3.3	3.4				

E000	M	ISO 529	6H		2.5XD	HSS-E PM	B 3.5-5					
E000TIN	M	ISO 529	6H		2.5XD	HSS-E PM	B 3.5-5			TIN		
E001	M	ISO 529	6H		2.5XD	HSS-E PM	B 3.5-5			ST		

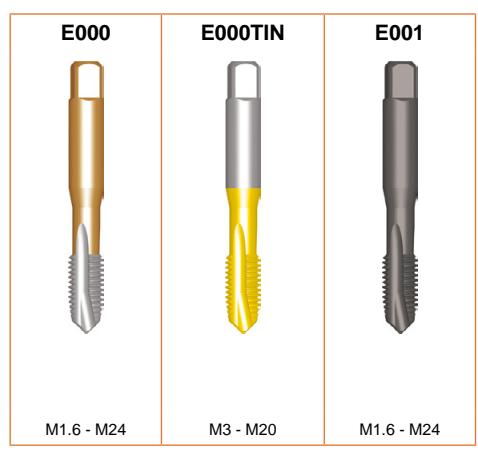
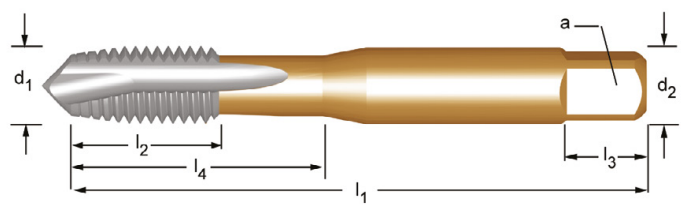

M	P mm	l ₁ mm	l ₂ mm	d ₂ Ø mm	□ a mm	l ₃ mm	z		l ₄ mm	E000	E000TIN	E001
1.6	0.35	41	7	2.50	2.00	4	2	1.25	7	E000M1.6		E001M1.6
2	0.40	41	8	2.50	2.00	4	2	1.6	8	E000M2		E001M2
2.5	0.45	44.5	9.5	2.80	2.24	5	2	2.05	9.5	E000M2.5		E001M2.5
3	0.50	48	15	3.15	2.50	5	3	2.5	15	E000M3	E000TINM3	E001M3
3.5	0.60	50	16	3.55	2.80	5	3	2.9	16	E000M3.5		E001M3.5
4	0.70	53	17	4.00	3.15	6	3	3.3	17	E000M4	E000TINM4	E001M4
5	0.80	58	11	5.00	4.00	7	3	4.2	22	E000M5	E000TINM5	E001M5
6	1.00	66	13	6.30	5.00	8	3	5.0	26	E000M6	E000TINM6	E001M6
8	1.25	72	16	8.00	6.30	9	3	6.8	29	E000M8	E000TINM8	E001M8
10	1.50	80	18	10.00	8.00	11	3	8.5	34	E000M10	E000TINM10	E001M10
12	1.75	89	22	9.00	7.10	10	3	10.3	-	E000M12	E000TINM12	E001M12
14	2.00	95	24	11.20	9.00	12	3	12.0	-	E000M14		E001M14
16	2.00	102	24	12.50	10.00	13	3	14.0	-	E000M16	E000TINM16	E001M16
18	2.50	112	29	14.00	11.20	14	4	15.5	-	E000M18		E001M18
20	2.50	112	29	14.00	11.20	14	4	17.5	-	E000M20	E000TINM20	E001M20
22	2.50	118	29	16.00	12.50	16	4	19.5	-	E000M22		E001M22
24	3.00	130	35	18.00	14.00	18	4	21.0	-	E000M24		E001M24

E606

- M závitník strojní extra dlouhý, lamač třísek, přímá drážka
- M Машинные метчики, сверхдлинные с подточкой по заборному конусу
- M Gwintownik maszynowy, bardzo długi prosty
- M závitník strojový, extra dlhý s lamačom triesok, priama drážka

Do vyprodání skladu dodáváno v HSS-E

HSS-E до складирования новой продукции

Do wyczerpania obecnych zapasow magazynowych dostepny ze stali HSS-E

Do vypredania skladu dodávané v HSS-E

E606 • 1.1 1.2 1.3 1.4 1.5 1.6 2.1 2.2 2.3 4.3 5.1 5.2 6.1 6.3 7.1 7.2 7.3 7.4 8.1

E606

M

ISO
2283

6H



2.5XD

HSS-E
PM

B
3.5-5

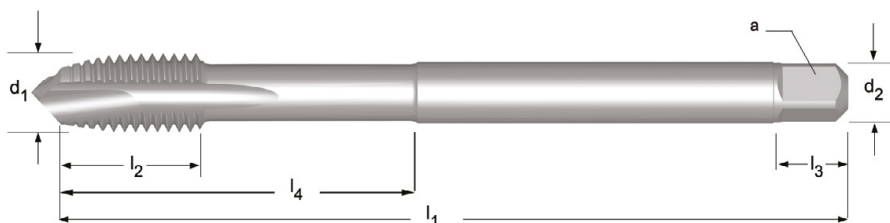

E606



M3 - M24

M	P mm	l ₁ mm	l ₂ mm	d ₂ ∅ mm	∠ a mm	l ₃ mm	z		l ₄ mm	E606
3	0.50	66	9	3.15	2.50	5	3	2.5	18	E606M3
4	0.70	73	12	3.15	2.50	5	3	3.3	-	E606M4
5	0.80	79	12	4.00	3.15	6	3	4.2	-	E606M5
6	1.00	89	14	4.50	3.55	6	3	5	-	E606M6
8	1.25	97	17	6.30	5.00	8	3	6.8	-	E606M8
10	1.50	108	19	8.00	6.30	9	3	8.5	-	E606M10
12	1.75	119	23	9.00	7.10	10	3	10.3	-	E606M12
14	2.00	127	25	11.20	9.00	12	3	12	-	E606M14
16	2.00	137	25	12.50	10.00	13	3	14	-	E606M16
20	2.50	149	30	14.00	11.20	14	4	17.5	-	E606M20
24	3.00	172	36	18.00	14.00	18	4	21	-	E606M24

- E216** • M Závítník strojní, přerušovaný, lamač třísek, přímá drážka Do vyprodání skladu dodáváno v HSS-E
- E266** • M Машинные метчики с шахматным расположением зубьев HSS-E до складирования новой продукции
- E422** • M Gwintownik maszynowy prosty z przerywanym nakrojem Do wyczerpania obecnych zapasów magazynowych dostepny ze stali HSS-E
- E423** • M strojový závitník, prerušovaný s lamačom triesok, priama drážka Do vypredania skladu dodávané v HSS-E

E216; E266; E422; E423	▪	1.2	1.3	1.4														
	•	1.1	1.5	3.1	3.2	3.3	3.4	4.1	4.3	5.1	5.2	6.1	6.2	6.3	7.1	7.2		
		7.3	7.4	8.1														

E216	M	DIN 371	6H		3XD	HSS-E PM	B 3.5-5				
E266	M	DIN 376	6H		3XD	HSS-E PM	B 3.5-5				
E422	M	DIN 371	6H		3XD	HSS-E PM	B 3.5-5				
E423	M	DIN 376	6H		3XD	HSS-E PM	B 3.5-5				

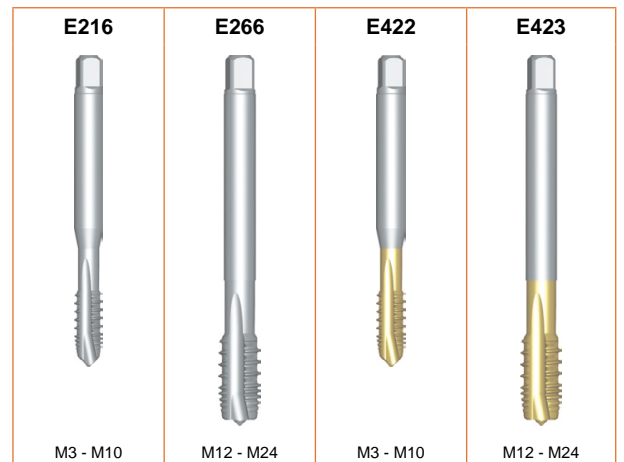
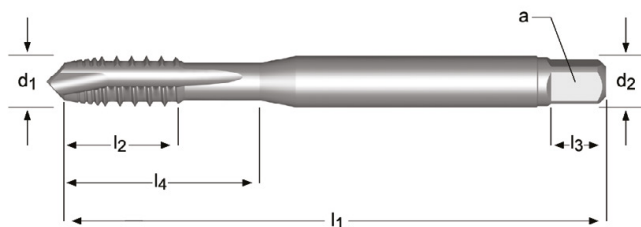

M	P mm	l ₁ mm	l ₂ mm	d ₂ Ø mm	∠ a mm	l ₃ mm	z		l ₄ mm	E216	E266	E422	E423
3	0.50	56	9	3.5	2.7	6	3	2.5	18	E216M3		E422M3	
4	0.70	63	12	4.5	3.4	6	3	3.3	21	E216M4		E422M4	
5	0.80	70	13	6.0	4.9	8	3	4.2	25	E216M5		E422M5	
6	1.00	80	15	6.0	4.9	8	3	5.0	30	E216M6		E422M6	
8	1.25	90	18	8.0	6.2	9	3	6.8	35	E216M8		E422M8	
10	1.50	100	20	10.0	8.0	11	3	8.5	39	E216M10		E422M10	
12	1.75	110	23	9.0	7.0	10	3	10.3			E266M12		E423M12
14	2.00	110	25	11.0	9.0	12	3	12.0			E266M14		E423M14
16	2.00	110	25	12.0	9.0	12	3	14.0			E266M16		E423M16
20	2.50	140	30	16.0	12.0	15	3	17.5			E266M20		E423M20
24	3.00	160	38	18.0	14.5	17	4	21.0			E266M24		E423M24

E207 • M strojní závitník, šroubovice 15°

Do vyprodání skladu dodáváno v HSS-E

E258 • M Машинные метчики со спиральной стружечной канавкой 15° HSS-E до складирования новой продукции

E212 • M Gwintownik maszynowy skrętny 15°

Do wyczerpania obecnych zapasów magazynowych dostepny ze stali HSS-E

E263 • M strojový závitník, skrutkovica 15°

Do vypredania skladu dodávané v HSS-E

E207; E258	▪	1.3	1.4				
	•	1.2	1.5	7.2	7.3		
E212; E263	▪	1.3	1.4				
	•	1.1	1.2	1.5	4.2	4.3	7.2

E207	M	DIN 371	6H		1.5XD	HSS-E PM	C 2-3				
E258	M	DIN 376	6H		1.5XD	HSS-E PM	C 2-3				
E212	M	DIN 371	6H		1.5XD	HSS-E PM	C 2-3				
E263	M	DIN 376	6H		1.5XD	HSS-E PM	C 2-3				

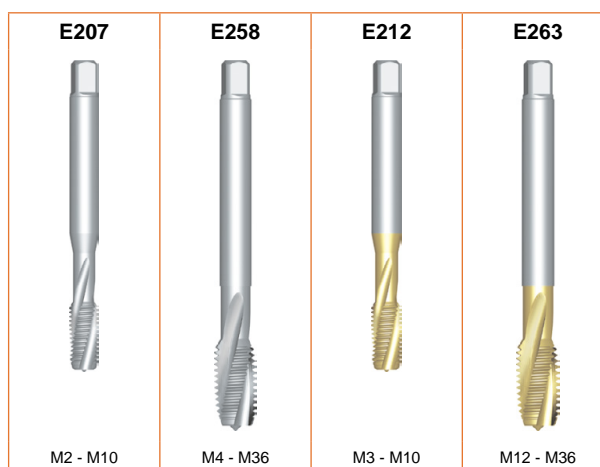
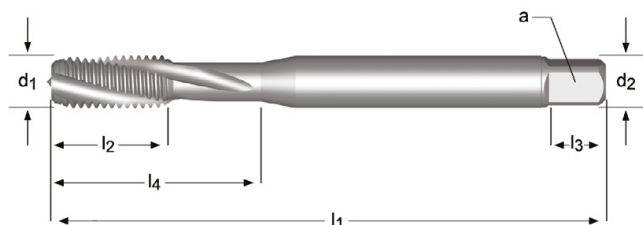

M	P mm	l ₁ mm	l ₂ mm	d ₂ Ø mm	□ a mm	l ₃ mm	z		l ₄ mm	E207	E258	E212	E263
2	0.40	45	4	2.8	2.1	5	3	1.6	9	E207M2			
2.5	0.45	50	4	2.8	2.1	5	3	2.05	12.5	E207M2.5			
3	0.50	56	9	3.5	2.7	6	3	2.5	18	E207M3		E212M3	
4	0.70	63	12	2.8	2.1	5	3	3.3			E258M4	E212M4	
4	0.70	63	12	4.5	3.4	6	3	3.3	21	E207M4			
5	0.80	70	13	3.5	2.7	6	3	4.2			E258M5		
5	0.80	70	13	6.0	4.9	8	3	4.2	25	E207M5		E212M5	
6	1.00	80	15	4.5	3.4	6	3	5.0			E258M6		
6	1.00	80	15	6.0	4.9	8	3	5	30	E207M6		E212M6	
8	1.25	90	18	6.0	4.9	8	3	6.8			E258M8		
8	1.25	90	18	8.0	6.2	9	3	6.8	35	E207M8		E212M8	
10	1.50	100	20	10.0	8.0	11	3	8.5	39	E207M10		E212M10	
10	1.50	100	20	7.0	5.5	8	3	8.5			E258M10		
12	1.75	110	23	9.0	7.0	10	3	10.3			E258M12		E263M12
14	2.00	110	25	11.0	9.0	12	3	12.0			E258M14		E263M14
16	2.00	110	25	12.0	9.0	12	3	14.0			E258M16		E263M16
18	2.50	125	30	14.0	11.0	14	3	15.5			E258M18		E263M18
20	2.50	140	30	16.0	12.0	15	3	17.5			E258M20		E263M20

M	P mm	l ₁ mm	l ₂ mm	d ₂ ∅ mm	∇ a mm	l ₃ mm	z	 mm	l ₄ mm	E207	E258	E212	E263
22	2.50	140	34	18.0	14.5	17	4	19.5			E258M22		E263M22
24	3.00	160	38	18.0	14.5	17	4	21.0			E258M24		E263M24
27	3.00	160	38	20.0	16.0	19	4	24.0			E258M27		E263M27
30	3.50	180	45	22.0	18.0	21	4	26.5			E258M30		E263M30
36	4.00	200	55	28.0	22.0	25	4	32.0			E258M36		E263M36

EX006H EX006G EX00TIN EX016H

• M strojní závitník, šroubovice 45°

Do vyprodání skladu dodáváno v HSS-E

• M Машинные метчики со спиральной стружечной канавкой 45°

HSS-E до складирования новой продукции

• M Gwintownik maszynowy skrętny 45°

Do wyczerpania obecnych zapasów magazynowych dostępy ze stali HSS-E

• M strojový závitník, skrutkovica 45°

Do vypredania skladu dodávané v HSS-E

EX006H; EX006G	▪	1.1	1.2	1.3	1.4	1.5	7.1	7.2	7.3	7.4
	•	4.1	4.2	5.1	5.2					
EX00TIN	▪	1.1	1.2	1.3	1.4	1.5	2.1	2.2	7.3	7.4
	•	2.3	3.1	3.2	3.3	3.4	4.1	4.2	5.1	5.2
EX016H	▪	1.1	1.2	1.3	1.4	1.5	2.1	2.2		
	•	2.3								

EX006H	M	DIN 371≤10 376≥12	6H		2.5XD	HSS-E PM	C 2-3				
EX006G	M	DIN 371≤10 376≥12	6G		2.5XD	HSS-E PM	C 2-3				
EX00TIN	M	DIN 371≤10 376≥12	6H		2.5XD	HSS-E PM	C 2-3			TIN	
EX016H	M	DIN 371≤10 376≥12	6H		2.5XD	HSS-E PM	C 2-3			ST	

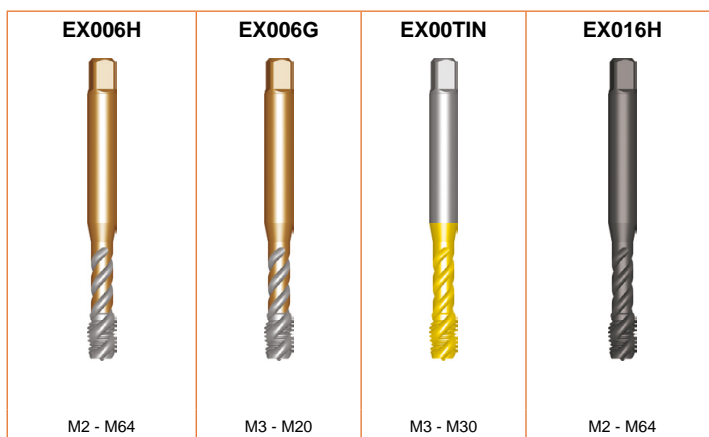
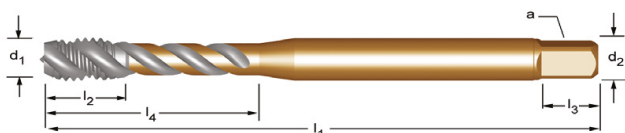

M	P mm	l ₁ mm	l ₂ mm	d ₂ ∅ mm	∠ a mm	l ₃ mm	z		l ₄ mm	EX006H	EX006G	EX00TIN	EX016H
2	0.40	45	4	2.8	2.1	5	3	1.6	9	EX00M2			EX01M2
2.5	0.45	50	4	2.8	2.1	5	3	2.05	12.5	EX00M2.5			EX01M2.5
3	0.50	56	6	3.5	2.7	6	3	2.5	18	EX00M3	EX00M36G	EX00TINM3	EX01M3
3.5	0.60	56	7	4.0	3.0	6	3	2.9	20	EX00M3.5			EX01M3.5
4	0.70	63	7	4.5	3.4	6	3	3.3	21	EX00M4	EX00M46G	EX00TINM4	EX01M4
5	0.80	70	8	6.0	4.9	8	3	4.2	25	EX00M5	EX00M56G	EX00TINM5	EX01M5
6	1.00	80	10	4.5	3.4	6	3	5	31	EX00M6DIN376			EX01M6DIN376
6	1.00	80	10	6.0	4.9	8	3	5	31	EX00M6	EX00M66G	EX00TINM6	EX01M6
7	1.00	80	10	7.0	5.5	8	3	6	31	EX00M7			EX01M7
8	1.25	90	12	8.0	6.2	9	3	6.8	35	EX00M8	EX00M86G	EX00TINM8	EX01M8
8	1.25	90	13	6.0	4.9	8	3	6.8	35	EX00M8DIN376			EX01M8DIN376
10	1.50	100	15	10.0	8.0	11	3	8.5	39	EX00M10	EX00M106G	EX00TINM10	EX01M10
10	1.50	100	15	7.0	5.5	8	3	8.5	39	EX00M10DIN376			EX01M10DIN376
12	1.75	110	16	9.0	7.0	10	3	10.3	-	EX00M12	EX00M126G	EX00TINM12	EX01M12
14	2.00	110	20	11.0	9.0	12	3	12	-	EX00M14	EX00M146G	EX00TINM14	EX01M14
16	2.00	110	20	12.0	9.0	12	4	14	-	EX00M16	EX00M166G	EX00TINM16	EX01M16
18	2.50	125	25	14.0	11.0	14	4	15.5	-	EX00M18		EX00TINM18	EX01M18
20	2.50	140	25	16.0	12.0	15	4	17.5	-	EX00M20	EX00M206G	EX00TINM20	EX01M20

M	P mm	l ₁ mm	l ₂ mm	d ₂ ∅ mm	□ a mm	l ₃ mm	z	 mm	l ₄ mm	EX006H	EX006G	EX00TIN	EX016H
22	2.50	140	25	18.0	14.5	17	4	19.5	-	EX00M22		EX00TINM22	EX01M22
24	3.00	160	30	18.0	14.5	17	4	21	-	EX00M24		EX00TINM24	EX01M24
27	3.00	160	30	20.0	16.0	19	4	24	-	EX00M27		EX00TINM27	EX01M27
30	3.50	180	36	22.0	18.0	21	4	26.5	-	EX00M30		EX00TINM30	EX01M30
33	3.50	180	36	25.0	20.0	23	4	29.5	-	EX00M33			EX01M33
36	4.00	200	40	28.0	22.0	25	4	32	-	EX00M36			EX01M36
39	4.00	200	40	32.0	24.0	27	4	35	-	EX00M39			EX01M39
42	4.50	200	45	32.0	24.0	27	4	37.5	-	EX00M42	¹⁾		EX01M42 ¹⁾
48	5.00	250	50	36.0	29.0	32	4	43	-	EX00M48	¹⁾		EX01M48 ¹⁾
52	5.00	250	50	40.0	32.0	35	5	47	-	EX00M52	¹⁾		EX01M52 ¹⁾
56	5.50	250	55	40.0	32.0	35	5	50.5	-	EX00M56	¹⁾		EX01M56 ¹⁾
64	6.00	315	60	50.0	39.0	42	6	58	-	EX00M64	¹⁾		EX01M64 ¹⁾

- E298**
- M strojní závitník, šroubovice 40°, žlutý Shark
 - M Машинный метчик со спиральной стружечной канавкой 40°, Yellow Shark
 - M Gwintownik maszynowy metryczny skrętny 40°, żółty Shark
 - M strojový závitník skrutkovica 40°, žltý Shark

E298 ■ 1.1 1.2 1.3 6.1 6.3
 • 1.4 1.5 6.2

E298 M DIN 371≤10 376≥12 6H  2XD HSS-E PM C 2-3  λ40°  Cr  L114 334

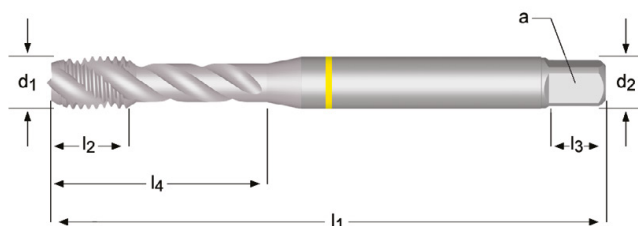

M	P mm	l ₁ mm	l ₂ mm	d ₂ Ø mm	□ a mm	l ₃ mm	z		l ₄ mm	E298
3	0.50	56	6	3.5	2.7	6	3	2.5	18	E298M3
4	0.70	63	7	4.5	3.4	6	3	3.3	21	E298M4
5	0.80	70	8	6.0	4.9	8	3	4.2	25	E298M5
6	1.00	80	10	6.0	4.9	8	3	5.0	30	E298M6
8	1.25	90	13	8.0	6.2	9	3	6.8	35	E298M8
10	1.50	100	15	10.0	8.0	11	3	8.5	39	E298M10
12	1.75	110	18	9.0	7.0	10	3	10.3	-	E298M12
14	2.00	110	20	11.0	9.0	12	3	12.0	-	E298M14
16	2.00	110	20	12.0	9.0	12	4	14.0	-	E298M16
18	2.50	125	25	14.0	11.0	14	4	15.5	-	E298M18
20	2.50	140	25	16.0	12.0	15	4	17.5	-	E298M20
22	2.50	140	25	18.0	14.5	17	4	19.5	-	E298M22
24	3.00	160	30	18.0	14.5	17	4	21.0	-	E298M24
27	3.00	160	30	20.0	16.0	19	4	24.0	-	E298M27
30	3.50	160	36	22.0	18.0	21	4	26.5	-	E298M30

- E412**
- M strojní závitník, šroubovice 48°, žlutý Shark, zpětný kuželový úkos
 - M Машинный метчик со спиральной стружечной канавкой 48°, Yellow Shark
 - M Gwintownik maszynowy metryczny skrętny 48°, żółty Shark
 - M strojový závitník skrutkovica 48°, žltý Shark spätný kuželový úkos

E412	▪	1.1	1.2	1.3	1.4	1.5		
	•	2.1	2.2	2.3	7.1	7.2	7.3	7.4

E412

M

DIN
371≤10
376≥12

6H



3XD

HSS-E
PM

C
2-3



TiAIN Top

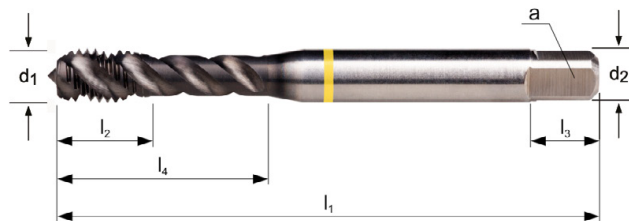

E412



M3 - M30

M	P mm	l ₁ mm	l ₂ mm	d ₂ ∅ mm	∟ a mm	l ₃ mm	z		l ₄ mm	E412
3	0.50	56	6	3.5	2.7	6	3	2.5	18	E412M3
4	0.70	63	7	4.5	3.4	6	3	3.3	21	E412M4
5	0.80	70	8	6.0	4.9	8	3	4.2	25	E412M5
6	1.00	80	10	6.0	4.9	8	3	5.0	30	E412M6
8	1.25	90	13	8.0	6.2	9	3	6.8	35	E412M8
10	1.50	100	15	10.0	8.0	11	3	8.5	39	E412M10
12	1.75	110	18	9.0	7.0	10	3	10.3	-	E412M12
14	2.00	110	20	11.0	9.0	12	3	12.0	-	E412M14
16	2.00	110	20	12.0	9.0	12	4	14.0	-	E412M16
20	2.50	140	25	16.0	12.0	15	4	17.5	-	E412M20
22	2.50	140	25	18.0	14.5	17	4	19.5	-	E412M22
24	3.00	160	30	18.0	14.5	17	4	21.0	-	E412M24
27	3.00	160	30	20.0	16.0	19	4	24.0	-	E412M27
30	3.50	180	36	22.0	18.0	21	4	26.5	-	E412M30

- M strojní závitník, šroubovice 45°, červený Shark, zpětný kuželový úkos Do vyprodání skladu dodáváno v HSS-E
- M Машинный метчик со спиральной стружечной канавкой 45°, Red Shark HSS-E до складирования новой продукции
- M Gwintownik maszynowy, metryczny, skretny 45°, czerwony Shark Do wyczerpania obecnych zapasów magazynowych dostepny ze stali HSS-E
- M strojový závitník, skrutkovica 45°, červený Shark, spätný kuželový úkos Do vypredania skladu dodávané v HSS-E

E260	▪	1.4			
	•	1.5	1.6	4.2	5.2
E261	▪	1.4	1.5		
	•	1.6	4.2	5.2	

E260	M	DIN 371≤10 376≥12	6H		2.5XD	HSS-E PM	C 2-3				
E261	M	DIN 371≤10 376≥12	6H		2.5XD	HSS-E PM	C 2-3			TAIN Top	

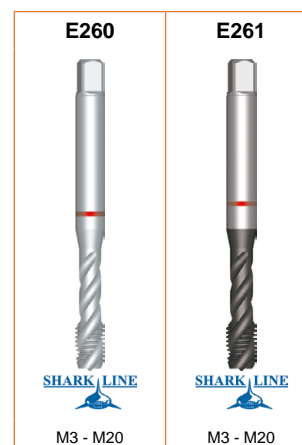
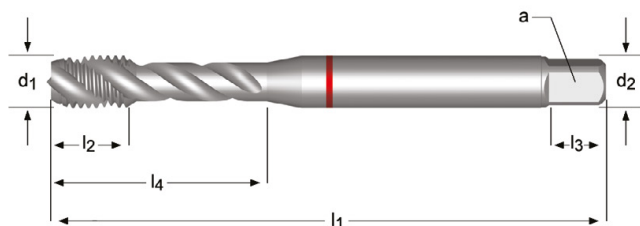

M	P mm	l ₁ mm	l ₂ mm	d ₂ ∅ mm	a mm	l ₃ mm	z		l ₄ mm	E260	E261
3	0.50	56	6	3.5	2.7	6	3	2.5	18	E260M3	E261M3
4	0.70	63	7	4.5	3.4	6	3	3.3	21	E260M4	E261M4
5	0.80	70	8	6.0	4.9	8	3	4.2	25	E260M5	E261M5
6	1.00	80	10	6.0	4.9	8	3	5.0	30	E260M6	E261M6
8	1.25	90	12	8.0	6.2	9	3	6.8	35	E260M8	E261M8
10	1.50	100	15	10.0	8.0	11	3	8.5	39	E260M10	E261M10
12	1.75	110	16	9.0	7.0	10	3	10.3	-	E260M12	E261M12
14	2.00	110	20	11.0	9.0	12	3	12.0	-	E260M14	-
16	2.00	110	20	12.0	9.0	12	4	14.0	-	E260M16	E261M16
20	2.50	140	25	16.0	12.0	15	4	17.5	-	E260M20	E261M20

E238

- M strojní závitník, šroubovice 40°, modrý Shark, zpětný kuželový úkos

Do vyprodání skladu dodáváno v HSS-E

E239

- M Машинный метчик со спиральной стружечной канавкой 40°, Blue Shark

HSS-E до складирования новой продукции

- M Gwintownik maszynowy metryczny skrętny 40°, niebieski Shark

Do wyczerpania obecnych zapasów magazynowych dostepny ze stali HSS-E

- M strojový závitník skrutkovica 40°, modrý Shark spätný kuželový úkos

Do vypredania skladu dodávané v HSS-E

E238 ■ 2.1 2.2 2.3

• 1.5

E239 ■ 2.1 2.2 2.3

• 1.2 1.3 1.4 1.5

E238	M	DIN 371≤10 376≥12	6H		2.5XD	HSS-E PM	C 2-3			ST	
E239	M	DIN 371≤10 376≥12	6H		2.5XD	HSS-E PM	C 2-3			Super B	

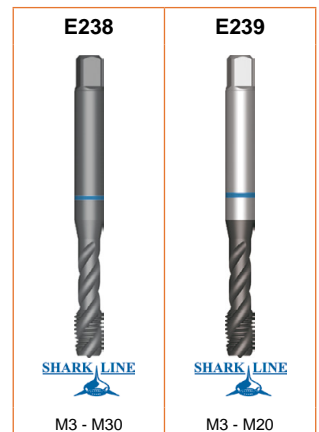
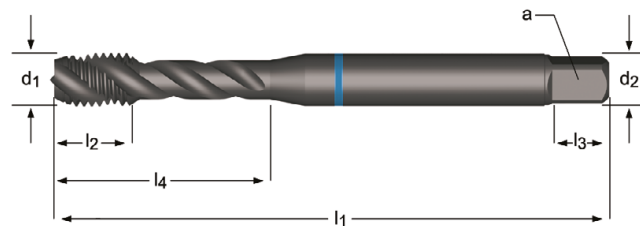

M	P mm	l ₁ mm	l ₂ mm	d ₂ Ø mm	∠ a mm	l ₃ mm	z		l ₄ mm	E238	E239
3	0.50	56	6	3.5	2.7	6	3	2.5	18	E238M3	E239M3
4	0.70	63	7	4.5	3.4	6	3	3.3	21	E238M4	E239M4
5	0.80	70	8	6.0	4.9	8	3	4.2	25	E238M5	E239M5
6	1.00	80	10	6.0	4.9	8	3	5.0	30	E238M6	E239M6
8	1.25	90	13	8.0	6.2	9	3	6.8	33	E238M8	E239M8
10	1.50	100	15	10.0	8.0	11	3	8.5	39	E238M10	E239M10
12	1.75	110	18	9.0	7.0	10	4	10.3	-	E238M12	E239M12
14	2.00	110	20	11.0	9.0	12	4	12.0	-	E238M14	E239M14
16	2.00	110	20	12.0	9.0	12	4	14.0	-	E238M16	E239M16
18	2.50	125	25	14.0	11.0	14	4	15.5	-	E238M18	
20	2.50	140	25	16.0	12.0	15	4	17.5	-	E238M20	E239M20
22	2.50	140	25	18.0	14.5	17	4	19.8	-	E238M22	
24	3.00	160	30	18.0	14.5	17	4	21.0	-	E238M24	
27	3.00	160	30	20.0	16.0	19	4	24.0	-	E238M27	
30	3.50	180	36	22.0	18.0	21	4	26.5	-	E238M30	

E414

- M strojní závitník, šroubovice 48°, modrý Shark, zpětný kuželový úkos
- M Машинный метчик со спиральной стружечной канавкой 48°, Blue Shark
- M Gwintownik maszynowy metryczny skrętny 48°, niebieski Shark
- M strojový závitník skrutkovica 48°, modrý Shark spätný kužeľový úkos

E414 ■ 2.1 2.2 2.3 2.4
 • 1.3 1.4 1.5

E414 M DIN 371≤10 376≥12 6H 3XD HSS-E PM C 2-3 λ48° Super B

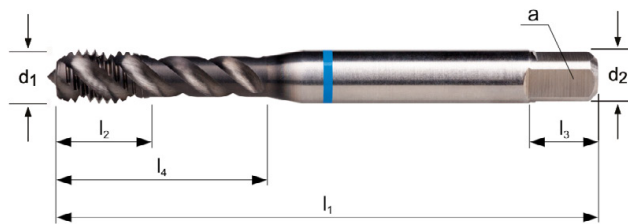

M	P mm	l ₁ mm	l ₂ mm	d ₂ ∅ mm	∠ a mm	l ₃ mm	z	↔	l ₄ mm	E414
3	0.50	56	6	3.5	2.7	6	3	2.5	18	E414M3
4	0.70	63	7	4.5	3.4	6	3	3.3	21	E414M4
5	0.80	70	8	6.0	4.9	8	3	4.2	25	E414M5
6	1.00	80	10	6.0	4.9	8	3	5.0	30	E414M6
8	1.25	90	13	8.0	6.2	9	3	6.8	35	E414M8
10	1.50	100	15	10.0	8.0	11	3	8.5	39	E414M10
12	1.75	110	18	9.0	7.0	10	3	10.3	-	E414M12
14	2.00	110	20	11.0	9.0	12	3	12.0	-	E414M14
16	2.00	110	20	12.0	9.0	12	4	14.0	-	E414M16
20	2.50	140	25	16.0	12.0	15	4	17.5	-	E414M20

E473

- M strojní závitník, šroubovice 35°, zelený Shark
- M Машинный метчик со спиральной стружечной канавкой 35°, Green Shark

Do vyprodání skladu dodáváno v HSS-E

E474

- M Gwintownik maszynowy, metryczny, skřętny 35°, zielony Shark
- M strojový závitník, skrutkovica 35°, zelený Shark

HSS-E до складирования новой продукции

Do wyczerpania obecnych zapasow magazynowych dostepny ze stali HSS-E

Do vypredania skladu dodávané v HSS-E

E473	▪	6.2	6.3	7.1	7.2	7.3	8.1
	•	1.1	1.2	1.3	6.1	7.4	
E474	▪	6.2	7.2	7.3	7.4		
	•	1.2	1.3	6.3	7.1	8.1	

E473	M	DIN 371≤10 376≥12	6H		2.5XD	HSS-E PM	C 2-3				
E474	M	DIN 371≤10 376≥12	6H		2.5XD	HSS-E PM	C 2-3			Super B	

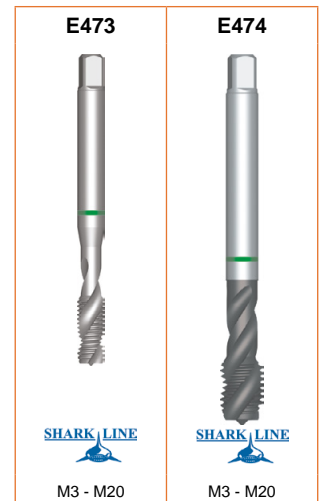
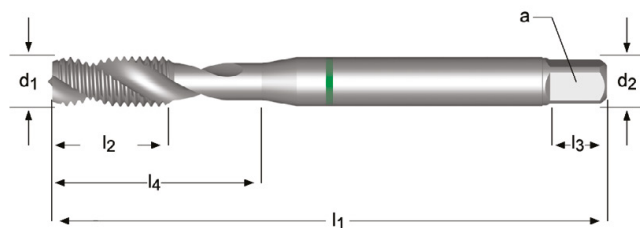

M	P mm	l ₁ mm	l ₂ mm	d ₂ ∅ mm	a mm	l ₃ mm	z		l ₄ mm	E473	E474
3	0.50	56	9	3.5	2.7	6	2	2.5	18	E473M3	E474M3
4	0.70	63	12	4.5	3.4	6	2	3.3	21	E473M4	E474M4
5	0.80	70	13	6.0	4.9	8	2	4.2	25	E473M5	E474M5
6	1.00	80	15	6.0	4.9	8	2	5.0	30	E473M6	E474M6
8	1.25	90	18	8.0	6.2	9	2	6.8	35	E473M8	E474M8
10	1.50	100	20	10.0	8.0	11	2	8.5	39	E473M10	E474M10
12	1.75	110	23	9.0	7.0	10	3	10.3	-	E473M12	E474M12
16	2.00	110	25	12.0	9.0	12	3	14.0	-	E473M16	E474M16
20	2.50	140	30	16.0	12.0	15	3	17.5	-	E473M20	E474M20

E002 E002TIN E003

- M strojní závitník, šroubovice 45°
- M Машинные метчики со спиральной стружечной канавкой 45°
- M Gwintownik maszynowy skrzyżny 45°
- M strojový závitník, skrutkovica 45°

Do vyprodání skladu dodáváno v HSS-E

HSS-E до складирования новой продукции

Do wyczerpania obecnych zapasow magazynowych dostepny ze stali HSS-E

Do vypredania skladu dodávané v HSS-E

E002	▪	1.1	1.2	1.3	1.4	1.5	7.1	7.2	7.3	7.4
	•	4.1	4.2	5.1	5.2					
E002TIN	▪	1.1	1.2	1.3	1.4	1.5	2.1	2.2	7.3	7.4
	•	2.3	3.1	3.2	3.3	3.4	4.1	4.2	5.1	5.2
E003	▪	1.1	1.2	1.3	1.4	1.5				
	•	2.1	2.2	2.3						

E002	M	ISO 529	6H		2.5XD	HSS-E PM	C 2-3	$\lambda 45^\circ$			L002 338	L113 333
E002TIN	M	ISO 529	6H		2.5XD	HSS-E PM	C 2-3	$\lambda 45^\circ$		TIN		
E003	M	ISO 529	6H		2.5XD	HSS-E PM	C 2-3	$\lambda 45^\circ$		ST	L113 333	

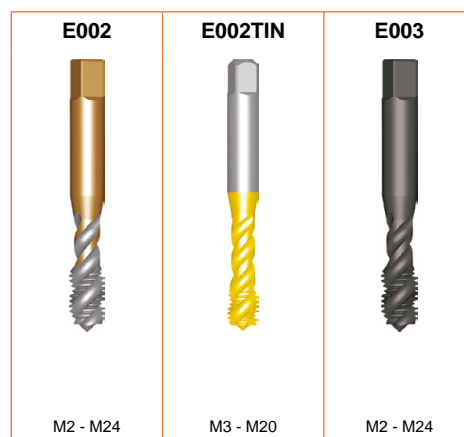
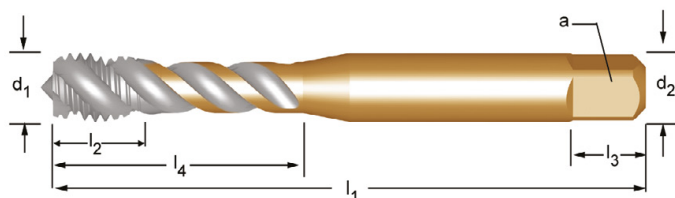

M	P mm	l ₁ mm	l ₂ mm	d ₂ ∅ mm	a mm	l ₃ mm	z		l ₄ mm	E002	E002TIN	E003
2	0.40	41	8	2.50	2.00	4	2	1.6	8	E002M2		E003M2
2.5	0.45	44.5	9.5	2.80	2.24	5	2	2.05	9.5	E002M2.5		E003M2.5
3	0.50	48	6	3.15	2.50	5	3	2.5	12.5	E002M3	E002TINM3	E003M3
4	0.70	53	7	4.00	3.15	6	3	3.3	19	E002M4	E002TINM4	E003M4
5	0.80	58	8	5.00	4.00	7	3	4.2	22	E002M5	E002TINM5	E003M5
6	1.00	66	10	6.30	5.00	8	3	5.0	27	E002M6	E002TINM6	E003M6
8	1.25	72	12	8.00	6.30	9	3	6.8	31	E002M8	E002TINM8	E003M8
10	1.50	80	15	10.00	8.00	11	3	8.5	35	E002M10	E002TINM10	E003M10
12	1.75	89	16	9.00	7.10	10	3	10.3	-	E002M12	E002TINM12	E003M12
14	2.00	95	18	11.20	9.00	12	3	12.0	-	E002M14		E003M14
16	2.00	102	18	12.50	10.00	13	4	14.0	-	E002M16	E002TINM16	E003M16
18	2.50	112	29	14.00	11.20	14	4	15.5	-	E002M18		E003M18
20	2.50	112	29	14.00	11.20	14	4	17.5	-	E002M20	E002TINM20	E003M20
22	2.50	118	29	16.00	12.50	16	4	19.5	-	E002M22		E003M22
24	3.00	130	35	18.00	14.00	18	4	21.0	-	E002M24		E003M24

- E650**
- M Závítník kombi
 - M Комбинированные метчики со спиральной стружечной канавкой 30°
 - M Wiertło/gwintownik skrętny 30°
 - M Závítník kombinovaný 30°

E650 • 1.1 1.2 1.3 1.4 3.2 6.2 6.3 7.1 7.2 8.1

E650 M DORMER ISO 6H 1.5XD HSS C 2-3 λ 30° ST L126 332

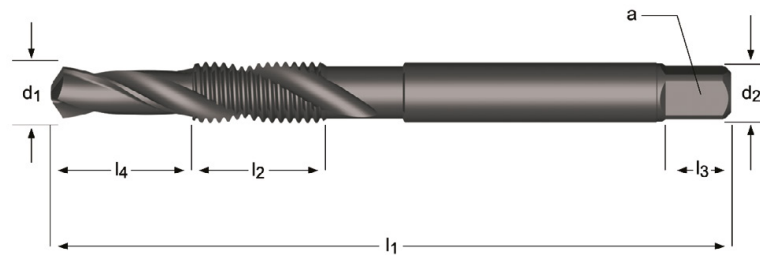

M	P mm	d ₁ nom mm	l ₁ mm	l ₂ mm	l ₄ mm	d ₂ ∅ mm	∠ a mm	l ₃ mm	z	E650
3	0.50	2.5	56	10	6	3.15	2.5	5.0	2	E650M3
4	0.70	3.3	65	12	8	4.0	3.15	6.0	2	E650M4
5	0.80	4.2	69	15	10	5.0	4.00	7.0	2	E650M5
6	1.00	5.0	84	18	12	6.3	5.00	8.0	2	E650M6
8	1.25	6.8	96	21	16	8.0	6.30	9.0	2	E650M8
10	1.50	8.5	108	22	20	10.0	8.00	11.0	2	E650M10
12	1.75	10.2	113	29	24	9.0	7.10	10.0	2	E650M12
14	2.00	12.0	123	30	28	11.2	9.00	12.0	2	E650M14
16	2.00	14.0	134	32	32	12.5	10.00	13.0	2	E650M16

E605

- M Závítník strojní, extra dlouhý, spirálovité drážky 40°
- M Машинные метчики, сверхдлинные со спиральной стружечной канавкой 40°
- M Gwintownik maszynowy, bardzo długi skrętny 40°
- M Závítník strojový, extra dlhý, špiralovité drážky 40°

Do vyprodání skladu dodáváno v HSS-E

HSS-E до складирования новой продукции

Do wyczerpania obecnych zapasów magazynowych dostepny ze stali HSS-E

Do vypredania skladu dodavane v HSS-E

E605 • 1.2 1.3 1.4 1.5 2.1 2.2 2.3 5.2 7.1 7.2 7.3 7.4

E605 M ISO 2283 6H 2XD HSS-E PM C 2-3 λ40°

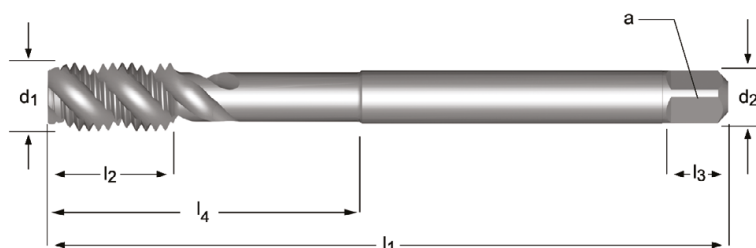

E605



M3 - M20

M	P mm	l ₁ mm	l ₂ mm	d ₂ ∅ mm	∠ a mm	l ₃ mm	z		l ₄ mm	E605
3	0.50	66	9	3.15	2.50	5	2	2.5	21	E605M3
4	0.70	73	9	4.00	3.15	6	2	3.3	22	E605M4
5	0.80	79	12	5.00	4.00	7	3	4.2	26	E605M5
6	1.00	89	12	6.30	5.00	8	3	5	29	E605M6
8	1.25	97	12	6.30	5.00	8	3	6.8	-	E605M8
10	1.50	108	14	8.00	6.30	9	3	8.5	-	E605M10
12	1.75	119	23	9.00	7.10	10	3	10.3	-	E605M12
14	2.00	127	25	11.20	9.00	12	3	12	-	E605M14
16	2.00	137	25	12.50	10.00	13	3	14	-	E605M16
20	2.50	149	30	14.00	11.20	14	3	17.5	-	E605M20

- E291** • M strojní tvářecí závitník
• M Метчик-раскатник
- E292** • M Wygniatak maszynowy
• M strojový tvárníaci závitník

- E294** • M strojní tvářecí závitník s mazacími drážkami
• M Метчик-раскатник с канавками для СОЖ
• M Wygniatak maszynowy, z rowkami smarowymi
• M strojový tvárníaci závitník s mazacími drážkami

- E289** • M strojní tvářecí závitník s mazacími drážkami a vnitřním chlazením
• M Метчики-Раскатники с канавками для смазки и внутренним подводом СОЖ
• M Wygniatak metryczny, rowki smarne i wewnętrzne chłodzenie
• M strojový tvárníaci závitník s mazacími drážkami a vnútorným chlazením

E291	▪	1.1	1.2	1.3	1.4	7.1	7.2						
	•	7.3											
E292; E294; E289	▪	1.1	1.2	1.3	1.4	2.1	2.2	4.1	5.1	7.1	7.2	7.3	
	•	1.5	2.3	5.2	6.1	6.3	7.4						

E291	M	DIN 2174	6HX		3XD	HSS-E	C 2-3.5					
E292	M	DIN 2174	6HX		3XD	HSS-E	C 2-3.5			TiN		
E294	M	DIN 2174	6HX		3.5XD	HSS-E	C 2-3.5			TiN		
E289	M	DIN 2174	6HX		3.5XD	HSS-E	C 2-3.5			TiN		

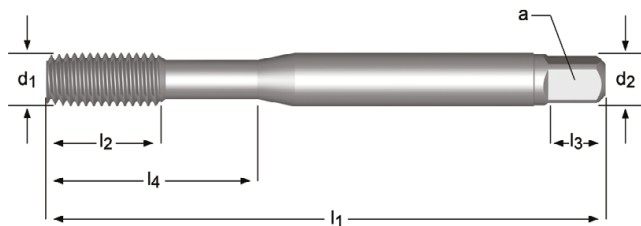

E291	E292	E294	E289
M1.6 - M16	M1.6 - M16	M3 - M16	M5 - M12

M	P mm	l ₁ mm	l ₂ mm	d ₂ Ø mm	□ a mm	l ₃ mm	z		l ₄ mm	E291	E292	E294	E289
1.6	0.35	40	8	2.5	2.1	5	3	1.4	-	E291M1.6	E292M1.6		
2	0.40	45	6	2.8	2.1	5	3	1.8	11	E291M2	E292M2		
2.5	0.45	50	8	2.8	2.1	5	3	2.3	12.5	E291M2.5	E292M2.5		
3	0.50	56	9	3.5	2.7	6	4	2.8	18	E291M3	E292M3	E294M3	
3.5	0.60	56	11	4.0	3.0	6	4	3.2	20	E291M3.5	E292M3.5		
4	0.70	63	12	4.5	3.4	6	5	3.7	21	E291M4	E292M4	E294M4	
5	0.80	70	13	6.0	4.9	8	5	4.6	25	E291M5	E292M5	E294M5	
6	1.00	80	15	6.0	4.9	8	5	5.5	30	E291M6	E292M6	E294M6	E289M5
8	1.25	90	18	8.0	6.2	9	5	7.4	35	E291M8	E292M8	E294M8	E289M6
10	1.50	100	20	10.0	8.0	11	5	9.3	39	E291M10	E292M10	E294M10	E289M8
12	1.75	110	23	9.0	7.0	10	5	11.2	-	E291M12	E292M12	E294M12	E289M10
14	2.00	110	25	11.0	9.0	12	6	13.0	-			E294M14	E289M12
16	2.00	110	25	12.0	9.0	12	6	15.0	-	E291M16	E292M16	E294M16	

E293

- M strojní tvářecí závitník
- M Метчик-раскатник
- M Wygniatak maszynowy
- M strojový tvárňaci závitník

E293	▪	1.1	1.2	1.3	1.4	2.1	2.2	4.1	5.1	7.1	7.2	7.3
	•	1.5	2.3	5.2	6.1	6.3	7.4					

E293 **M** **DIN 2174** **6HX** **3XD** **HSS-E** **E 1.5-2**    

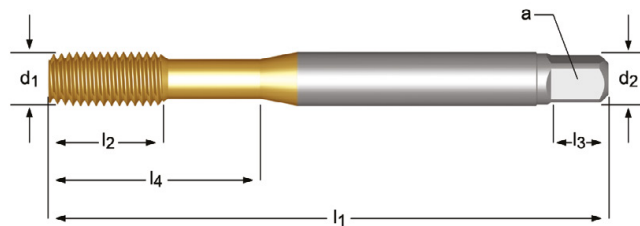

E293



M3 - M16

M	P mm	l ₁ mm	l ₂ mm	d ₂ Ø mm	□ a mm	l ₃ mm	z		l ₄ mm	E293
3	0.50	56	9	3.5	2.7	6	4	2.8	18	E293M3
4	0.70	63	12	4.5	3.4	6	5	3.7	21	E293M4
5	0.80	70	13	6.0	4.9	8	5	4.6	25	E293M5
6	1.00	80	15	6.0	4.9	8	5	5.5	30	E293M6
8	1.25	90	18	8.0	6.2	9	5	7.4	35	E293M8
10	1.50	100	20	10.0	8.0	11	5	9.3	39	E293M10
12	1.75	110	23	9.0	7.0	10	5	11.2	-	E293M12
16	2.00	110	25	12.0	9.0	12	6	15.0	-	E293M16

- E295** • M strojní tvářecí závitník
 • M Метчик-раскатник
- E296** • M Wygniatak maszynowy
 • M strojový tvárňaci závitník

E295; E296 ■ 1.1 1.2 1.3 1.4 2.1 2.2 4.1 5.1 7.1 7.2 7.3
 • 1.5 2.3 5.2 6.1 6.3 7.4

E295	M	DIN 2174	6GX		3XD	HSS-E	C 2-3.5			TiN	
E296	M	DIN 2174	6GX		3XD	HSS-E	E 1.5-2			TiN	

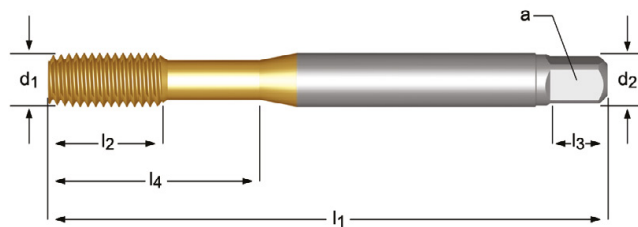

M	P mm	l ₁ mm	l ₂ mm	d ₂ Ø mm	□ a mm	l ₃ mm	z		l ₄ mm	E295	E296
3	0.50	56	9	3.5	2.7	6	4	2.8	18	E295M3	E296M3
3.5	0.60	56	11	4.0	3.0	6	4	3.2	20	E295M3.5	
4	0.70	63	12	4.5	3.4	6	5	3.7	21	E295M4	E296M4
5	0.80	70	13	6.0	4.9	8	5	4.6	25	E295M5	E296M5
6	1.00	80	15	6.0	4.9	8	5	5.5	30	E295M6	E296M6
8	1.25	90	18	8.0	6.2	9	5	7.4	35	E295M8	E296M8
10	1.50	100	20	10.0	8.0	11	5	9.3	39	E295M10	E296M10
12	1.75	110	23	9.0	7.0	10	5	11.2	-	E295M12	

E105

- MF Závítník ruční, přímá drážka
- MF Ручные метчики с прямой стружечной канавкой
- MF Gwintownik ręczny, prosty rowek wiórowy
- MF Závítník ručný, priama drážka

E105 • 1.1 1.2 1.3 1.4 1.5 3.1 3.2 3.3 3.4 6.1 6.2 6.3 6.4 7.2 7.3 7.4 8.2 8.3

E105

MF

DIN
2181

6H



1.5XD

HSS

C
2-3

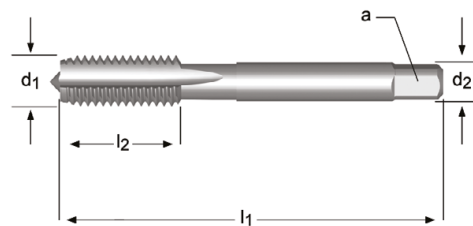

E105



M2.5 - M50

MF	P mm	l_1 mm	l_2 mm	d_2 mm	\square a mm	z	\leftrightarrow	E105
2.5	0.35	40	9	2.8	2.1	3	2.15	E105M2.5X.35NO3
2.5	0.35	40	9	2.8	2.1	3	2.15	E105M2.5X.35NO9
3	0.35	40	9	3.5	2.7	3	2.65	E105M3X.35NO3
3	0.35	40	9	3.5	2.7	3	2.65	E105M3X.35NO9
3.5	0.35	45	10	4.0	3.0	3	3.2	E105M3.5X.35NO3
3.5	0.35	45	10	4.0	3.0	3	3.2	E105M3.5X.35NO9
4	0.50	45	12	4.5	3.4	3	3.5	E105M4X.5NO3
4	0.50	45	12	4.5	3.4	3	3.5	E105M4X.5NO9
5	0.50	50	14	6.0	4.9	3	4.5	E105M5X.5NO3
5	0.50	50	14	6.0	4.9	3	4.5	E105M5X.5NO9
5.5	0.50	56	16	6.0	4.9	3	5	E105M5.5X.5NO9
6	0.75	56	16	6.0	4.9	3	5.3	E105M6X.75NO3
6	0.75	56	16	6.0	4.9	3	5.3	E105M6X.75NO9
7	0.75	56	16	6.0	4.9	3	6.3	E105M7X.75NO3
7	0.75	56	16	6.0	4.9	3	6.3	E105M7X.75NO9
8	0.75	56	16	6.0	4.9	3	7.3	E105M8X.75NO3
8	0.75	56	16	6.0	4.9	3	7.3	E105M8X.75NO9
8	1.00	63	19	6.0	4.9	3	7	E105M8X1.0NO3
8	1.00	63	19	6.0	4.9	3	7	E105M8X1.0NO9
9	0.75	63	19	7.0	5.5	3	8.3	E105M9X.75NO3
9	0.75	63	19	7.0	5.5	3	8.3	E105M9X.75NO9
9	1.00	63	19	7.0	5.5	3	8	E105M9X1.0NO3
9	1.00	63	19	7.0	5.5	3	8	E105M9X1.0NO9
10	0.75	63	16	7.0	5.5	3	9.3	E105M10X.75NO3
10	0.75	63	16	7.0	5.5	3	9.3	E105M10X.75NO9
10	1.00	63	16	7.0	5.5	3	9	E105M10X1.0NO3
10	1.00	63	16	7.0	5.5	3	9	E105M10X1.0NO9
10	1.25	70	22	7.0	5.5	3	8.8	E105M10X1.25NO3
10	1.25	70	22	7.0	5.5	3	8.8	E105M10X1.25NO9
11	0.75	63	15	8.0	6.2	3	10.3	E105M11X.75NO3
11	0.75	63	15	8.0	6.2	3	10.3	E105M11X.75NO9
11	1.00	63	15	8.0	6.2	3	10	E105M11X1.0NO3
11	1.00	63	15	8.0	6.2	3	10	E105M11X1.0NO9
12	1.00	70	16	9.0	7.0	3	11	E105M12X1.0NO3
12	1.00	70	16	9.0	7.0	3	11	E105M12X1.0NO9
12	1.25	70	16	9.0	7.0	3	10.8	E105M12X1.25NO3
12	1.25	70	16	9.0	7.0	3	10.8	E105M12X1.25NO9
12	1.50	70	16	9.0	7.0	3	10.5	E105M12X1.5NO3
12	1.50	70	16	9.0	7.0	3	10.5	E105M12X1.5NO9
14	1.00	70	16	11.0	9.0	4	13	E105M14X1.0NO3

N01 - N09
219

MF	P mm	l ₁ mm	l ₂ mm	d ₂ ∅ mm	□ a mm	z		E105
14	1.00	70	16	11.0	9.0	4	13	E105M14X1.0NO9
14	1.25	70	16	11.0	9.0	4	12.8	E105M14X1.25NO3
14	1.25	70	16	11.0	9.0	4	12.8	E105M14X1.25NO9
14	1.50	70	16	11.0	9.0	4	12.5	E105M14X1.5NO3
14	1.50	70	16	11.0	9.0	4	12.5	E105M14X1.5NO9
15	1.00	70	16	12.0	9.0	4	14	E105M15X1.0NO3
15	1.00	70	16	12.0	9.0	4	14	E105M15X1.0NO9
15	1.50	70	16	12.0	9.0	4	13.5	E105M15X1.5NO3
15	1.50	70	16	12.0	9.0	4	13.5	E105M15X1.5NO9
16	1.00	70	16	12.0	9.0	4	15	E105M16X1.0NO3
16	1.00	70	16	12.0	9.0	4	15	E105M16X1.0NO9
16	1.50	70	16	12.0	9.0	4	14.5	E105M16X1.5NO3
16	1.50	70	16	12.0	9.0	4	14.5	E105M16X1.5NO9
18	1.00	80	18	14.0	11.0	4	17	E105M18X1.0NO3
18	1.00	80	18	14.0	11.0	4	17	E105M18X1.0NO9
18	1.50	80	18	14.0	11.0	4	16.5	E105M18X1.5NO3
18	1.50	80	18	14.0	11.0	4	16.5	E105M18X1.5NO9
20	1.00	80	18	16.0	12.0	4	19	E105M20X1.0NO3
20	1.00	80	18	16.0	12.0	4	19	E105M20X1.0NO9
20	1.50	80	18	16.0	12.0	4	18.5	E105M20X1.5NO3
20	1.50	80	18	16.0	12.0	4	18.5	E105M20X1.5NO9
22	1.00	80	22	18.0	14.5	4	21	E105M22X1.0NO3
22	1.00	80	22	18.0	14.5	4	21	E105M22X1.0NO9
22	1.50	80	22	18.0	14.5	4	20.5	E105M22X1.5NO3
22	1.50	80	22	18.0	14.5	4	20.5	E105M22X1.5NO9
24	1.00	90	22	18.0	14.5	4	23	E105M24X1.0NO3
24	1.00	90	22	18.0	14.5	4	23	E105M24X1.0NO9
24	1.50	90	22	18.0	14.5	4	22.5	E105M24X1.5NO3
24	1.50	90	22	18.0	14.5	4	22.5	E105M24X1.5NO9
24	2.00	90	22	18.0	14.5	4	22	E105M24X2.0NO3
24	2.00	90	22	18.0	14.5	4	22	E105M24X2.0NO9
25	1.50	90	22	18.0	14.5	4	23.5	E105M25X1.5NO3
25	1.50	90	22	18.0	14.5	4	23.5	E105M25X1.5NO9
25	2.00	90	22	18.0	14.5	4	23	E105M25X2.0NO3
25	2.00	90	22	18.0	14.5	4	23	E105M25X2.0NO9
27	1.50	90	22	20.0	16.0	4	25.5	E105M27X1.5NO3
27	1.50	90	22	20.0	16.0	4	25.5	E105M27X1.5NO9
27	2.00	90	22	20.0	16.0	4	25	E105M27X2.0NO3
27	2.00	90	22	20.0	16.0	4	25	E105M27X2.0NO9
28	1.50	90	22	20.0	16.0	4	26.5	E105M28X1.5NO3
28	1.50	90	22	20.0	16.0	4	26.5	E105M28X1.5NO9
28	2.00	90	22	20.0	16.0	4	26	E105M28X2.0NO3
28	2.00	90	22	20.0	16.0	4	26	E105M28X2.0NO9
30	1.50	90	22	22.0	18.0	4	28.5	E105M30X1.5NO3
30	1.50	90	22	22.0	18.0	4	28.5	E105M30X1.5NO9
30	2.00	90	22	22.0	18.0	4	28	E105M30X2.0NO3
30	2.00	90	22	22.0	18.0	4	28	E105M30X2.0NO9
32	1.50	90	22	22.0	18.0	4	30.5	E105M32X1.5NO3
32	1.50	90	22	22.0	18.0	4	30.5	E105M32X1.5NO9
32	2.00	90	22	22.0	18.0	4	30	E105M32X2.0NO3
32	2.00	90	22	22.0	18.0	4	30	E105M32X2.0NO9
36	1.50	100	25	28.0	22.0	4	34.5	E105M36X1.5NO3
36	1.50	100	25	28.0	22.0	4	34.5	E105M36X1.5NO9
36	2.00	125	40	28.0	22.0	4	34	E105M36X2.0NO3
36	2.00	125	40	28.0	22.0	4	34	E105M36X2.0NO9
36	3.00	125	40	28.0	22.0	4	33	E105M36X3.0NO3
36	3.00	125	40	28.0	22.0	4	33	E105M36X3.0NO9
40	1.50	110	25	32.0	24.0	4	38.5	E105M40X1.5NO3
40	1.50	110	25	32.0	24.0	4	38.5	E105M40X1.5NO9
40	2.00	125	40	32.0	24.0	4	38	E105M40X2.0NO3
40	2.00	125	40	32.0	24.0	4	38	E105M40X2.0NO9
40	3.00	125	40	32.0	24.0	4	37	E105M40X3.0NO3
40	3.00	125	40	32.0	24.0	4	37	E105M40X3.0NO9
42	1.50	110	25	32.0	24.0	4	40.5	E105M42X1.5NO3
42	1.50	110	25	32.0	24.0	4	40.5	E105M42X1.5NO9
42	2.00	125	40	32.0	24.0	4	40	E105M42X2.0NO3
42	2.00	125	40	32.0	24.0	4	40	E105M42X2.0NO9
42	3.00	125	40	32.0	24.0	4	39	E105M42X3.0NO3
42	3.00	125	40	32.0	24.0	4	39	E105M42X3.0NO9
45	1.50	110	25	36.0	29.0	6	43.5	E105M45X1.5NO3

NO1 - NO9
219



MF	P mm	l ₁ mm	l ₂ mm	d ₂ ∅ mm	□ a mm	z		E105
45	1.50	110	25	36.0	29.0	6	43.5	E105M45X1.5NO9
45	2.00	125	40	36.0	29.0	6	43	E105M45X2.0NO3
45	2.00	125	40	36.0	29.0	6	43	E105M45X2.0NO9
45	3.00	125	40	36.0	29.0	6	42	E105M45X3.0NO3
45	3.00	125	40	36.0	29.0	6	42	E105M45X3.0NO9
48	1.50	140	40	36.0	29.0	6	46.5	E105M48X1.5NO3
48	1.50	140	40	36.0	29.0	6	46.5	E105M48X1.5NO9
48	2.00	140	40	36.0	29.0	6	46	E105M48X2.0NO3
48	2.00	140	40	36.0	29.0	6	46	E105M48X2.0NO9
48	3.00	140	40	36.0	29.0	6	45	E105M48X3.0NO3
48	3.00	140	40	36.0	29.0	6	45	E105M48X3.0NO9
50	1.50	140	40	36.0	29.0	6	48.5	E105M50X1.5NO3
50	1.50	140	40	36.0	29.0	6	48.5	E105M50X1.5NO9
50	2.00	140	40	36.0	29.0	6	48	E105M50X2.0NO3
50	2.00	140	40	36.0	29.0	6	48	E105M50X2.0NO9
50	3.00	140	40	36.0	29.0	6	47	E105M50X3.0NO3
50	3.00	140	40	36.0	29.0	6	47	E105M50X3.0NO9

NO1 - NO9



219

E268
E242
E290

- MF strojní závitník Do vyprodání skladu dodáváno v HSS-E
- MF Машинные метчики с прямой стружечной канавкой HSS-E до складирования новой продукции
- MF Gwintownik maszynowy, prosty rowek wiórowy Do wyczerpania obecnych zapasów magazynowych dostepny ze stali HSS-E
- MF strojový závitník Do vypredania skladu dodávané v HSS-E

E268; E242; E290 • 1.1 1.2 1.3 1.4 1.5 3.1 3.2 3.3 6.2 6.3 7.2 7.3 8.2

E268	MF	DIN 374	6H		1.5XD	HSS-E PM	C 2-3				
E242	MF	DIN 371	6H		1.5XD	HSS-E PM	C 2-3				
E290	MF	DIN 374	6H		1.5XD	HSS-E PM	C 2-3				

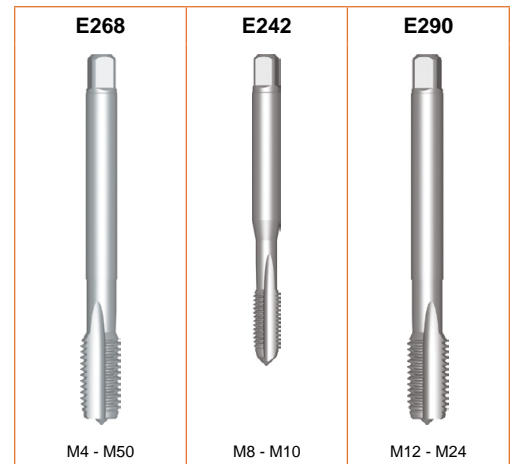
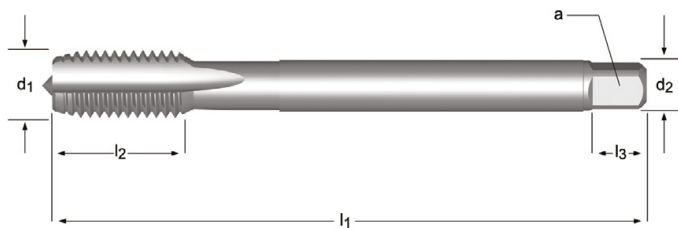

MF	P mm	l ₁ mm	l ₂ mm	d ₂ Ø mm	□ a mm	l ₃ mm	z		l ₄ mm	E268	E242	E290
4	0.50	63	10	2.8	2.1	5	3	3.5		E268M4X.5		
5	0.50	70	13	3.5	2.7	6	3	4.5		E268M5X.5		
6	0.75	80	15	4.5	3.4	6	3	5.3		E268M6X.75		
7	0.75	80	15	5.5	4.3	7	3	6.3		E268M7X.75		
8	0.75	80	15	6.0	4.9	8	3	7.3		E268M8X.75		
8	1.00	90	18	6.0	4.9	8	3	7.0		E268M8X1.0		
8	1.00	90	18	8.0	6.2	9	3	7.0	35		E242M8X1.0	
9	1.00	90	18	6.0	4.9	8	3	8.0		E268M9X1.0		
10	0.75	90	20	7.0	5.5	8	3	9.3		E268M10X.75		
10	1.00	100	20	10.0	8.0	11	3	9.0	39		E242M10X1.0	
10	1.00	90	20	7.0	5.5	8	3	9.0		E268M10X1.0		
10	1.25	100	20	7.0	5.5	8	3	8.8		E268M10X1.25		
11	1.00	90	20	8.0	6.2	9	3	10.0		E268M11X1.0		
12	1.00	100	21	9.0	7.0	10	4	11.0		E268M12X1.0		E290M12X1.0
12	1.25	100	21	9.0	7.0	10	4	10.8		E268M12X1.25		
12	1.50	100	21	9.0	7.0	10	4	10.5		E268M12X1.5		E290M12X1.5
14	1.00	100	21	11.0	9.0	12	4	13.0		E268M14X1.0		E290M14X1.0
14	1.25	100	21	11.0	9.0	12	4	12.8		E268M14X1.25		
14	1.50	100	21	11.0	9.0	12	4	12.5		E268M14X1.5		E290M14X1.5
15	1.50	100	21	12.0	9.0	12	4	13.5		E268M15X1.5		
16	1.00	100	21	12.0	9.0	12	4	15.0		E268M16X1.0		E290M16X1.0
16	1.50	100	21	12.0	9.0	12	4	14.5		E268M16X1.5		E290M16X1.5
18	1.00	110	24	14.0	11.0	14	4	17.0		E268M18X1.0		
18	1.50	110	24	14.0	11.0	14	4	16.5		E268M18X1.5		E290M18X1.5
20	1.00	125	24	16.0	12.0	15	4	19.0		E268M20X1.0		
20	1.50	125	24	16.0	12.0	15	4	18.5		E268M20X1.5		E290M20X1.5
22	1.00	125	25	18.0	14.5	17	4	21.0		E268M22X1.0		
22	1.50	125	25	18.0	14.5	17	4	20.5		E268M22X1.5		E290M22X1.5

MF	P mm	l ₁ mm	l ₂ mm	d ₂ ∅ mm	□ a mm	l ₃ mm	z		l ₄ mm	E268	E242	E290
24	1.00	140	28	18.0	14.5	17	4	23.0		E268M24X1.0		
24	1.50	140	28	18.0	14.5	17	4	22.5		E268M24X1.5		E290M24X1.5
24	2.00	140	28	18.0	14.5	17	4	22.0		E268M24X2.0		
25	1.50	140	28	18.0	14.5	17	4	23.5		E268M25X1.5		
25	2.00	140	28	18.0	14.5	17	4	23.0		E268M25X2.0		
26	1.50	140	28	18.0	14.5	17	4	24.5		E268M26X1.5		
26	2.00	140	28	18.0	14.5	17	4	24.0		E268M26X2.0		
27	1.50	140	28	20.0	16.0	19	4	25.5		E268M27X1.5		
27	2.00	140	28	20.0	16.0	19	4	25.0		E268M27X2.0		
28	1.50	140	28	20.0	16.0	19	4	26.5		E268M28X1.5		
28	2.00	140	28	20.0	16.0	19	4	26.0		E268M28X2.0		
30	1.50	150	28	22.0	18.0	21	4	28.5		E268M30X1.5		
30	2.00	150	28	22.0	18.0	21	4	28.0		E268M30X2.0		
32	1.50	150	28	22.0	18.0	21	4	30.5		E268M32X1.5		
32	2.00	150	28	22.0	18.0	21	4	30.0		E268M32X2.0		
33	1.50	160	30	25.0	20.0	23	4	31.5		E268M33X1.5		
34	1.50	170	30	28.0	22.0	25	4	32.5		E268M34X1.5		
35	1.50	170	30	28.0	22.0	25	4	33.5		E268M35X1.5		
36	1.50	170	30	28.0	22.0	25	4	34.5		E268M36X1.5		
36	2.00	170	30	28.0	22.0	25	4	34.0		E268M36X2.0		
36	3.00	200	55	28.0	22.0	25	4	33.0		E268M36X3.0		
40	1.50	170	30	32.0	24.0	27	4	38.5		E268M40X1.5		
40	2.00	170	30	32.0	24.0	27	4	38.0		E268M40X2.0		
40	3.00	200	60	32.0	24.0	27	4	37.0		E268M40X3.0		
42	1.50	170	30	32.0	24.0	27	4	40.5		E268M42X1.5	¹⁾	
42	2.00	170	30	32.0	24.0	27	4	40.0		E268M42X2.0	¹⁾	
42	3.00	200	60	32.0	24.0	27	4	39.0		E268M42X3.0	¹⁾	
45	1.50	180	32	36.0	29.0	32	6	43.5		E268M45X1.5	¹⁾	
45	2.00	180	32	36.0	29.0	32	6	43.0		E268M45X2.0	¹⁾	
45	3.00	200	42	36.0	29.0	32	6	42.0		E268M45X3.0	¹⁾	
48	1.50	190	32	36.0	29.0	32	6	46.5		E268M48X1.5	¹⁾	
48	2.00	190	32	36.0	29.0	32	6	46.0		E268M48X2.0	¹⁾	
48	3.00	225	50	36.0	29.0	32	6	45.0		E268M48X3.0	¹⁾	
50	1.50	190	32	36.0	29.0	32	6	48.5		E268M50X1.5	¹⁾	
50	2.00	190	30	36.0	29.0	32	6	48.0		E268M50X2.0	¹⁾	
50	3.00	225	50	36.0	29.0	32	6	47.0		E268M50X3.0	¹⁾	

- E513**
- MF strojní závitník
 - MF Машинные метчики с прямой стружечной канавкой
 - MF Gwintownik maszynowy, prosty rowek wiórowy
 - MF strojový závitník

E513 • 1.1 1.2 1.3 1.4 1.5 3.1 3.2 3.3 3.4 6.1 6.2 6.3 6.4 7.2 7.3 7.4 8.2 8.3

E513 MF ISO 529 6H 1.5XD HSS

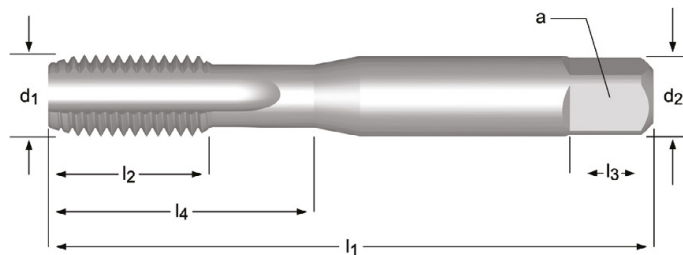

MF	P mm	l ₁ mm	l ₂ mm	d ₂ ∅ mm	a mm	l ₃ mm	z		l ₄ mm	E513
3	0.35	48	12.5	3.15	2.50	5	3	2.65	12.5	E513M3X.35NO1
3	0.35	48	12.5	3.15	2.50	5	3	2.65	12.5	E513M3X.35NO2
3	0.35	48	12.5	3.15	2.50	5	3	2.65	12.5	E513M3X.35NO3
3.5	0.35	48	12.5	3.15	2.50	5	3	3.2	12.5	E513M3.5X.35NO3
4	0.50	53	14	4.00	3.15	6	3	3.5	14	E513M4X.5NO1
4	0.50	53	14	4.00	3.15	6	3	3.5	14	E513M4X.5NO2
4	0.50	53	14	4.00	3.15	6	3	3.5	14	E513M4X.5NO3
4	0.50	53	14	4.00	3.15	6	3	3.5	14	E513M4X.5NO7
5	0.50	58	11	5.00	4.00	7	3	4.5	22	E513M5X.5NO1
5	0.50	58	11	5.00	4.00	7	3	4.5	22	E513M5X.5NO2
5	0.50	58	11	5.00	4.00	7	3	4.5	22	E513M5X.5NO3
5	0.50	58	11	5.00	4.00	7	3	4.5	22	E513M5X.5NO7
5	0.75	58	11	5.00	4.00	7	3	4.3	22	E513M5X.75NO1
5	0.75	58	11	5.00	4.00	7	3	4.3	22	E513M5X.75NO2
5	0.75	58	11	5.00	4.00	7	3	4.3	22	E513M5X.75NO3
6	0.50	66	13	6.30	5.00	8	3	5.5	26	E513M6X.5NO1
6	0.50	66	13	6.30	5.00	8	3	5.5	26	E513M6X.5NO2
6	0.50	66	13	6.30	5.00	8	3	5.5	26	E513M6X.5NO3
6	0.75	66	13	6.30	5.00	8	3	5.3	26	E513M6X.75NO1
6	0.75	66	13	6.30	5.00	8	3	5.3	26	E513M6X.75NO2
6	0.75	66	13	6.30	5.00	8	3	5.3	26	E513M6X.75NO3
6	0.75	66	13	6.30	5.00	8	3	5.3	26	E513M6X.75NO7
7	0.75	66	13	7.10	5.60	8	3	6.3	26	E513M7X.75NO1
7	0.75	66	13	7.10	5.60	8	3	6.3	26	E513M7X.75NO2
7	0.75	66	13	7.10	5.60	8	3	6.3	26	E513M7X.75NO3
8	0.50	72	16	8.00	6.30	9	3	7.5	29	E513M8X.5NO1
8	0.50	72	16	8.00	6.30	9	3	7.5	29	E513M8X.5NO2
8	0.50	72	16	8.00	6.30	9	3	7.5	29	E513M8X.5NO3
8	0.75	72	16	8.00	6.30	9	3	7.3	29	E513M8X.75NO1
8	0.75	72	16	8.00	6.30	9	3	7.3	29	E513M8X.75NO2
8	0.75	72	16	8.00	6.30	9	3	7.3	29	E513M8X.75NO3
8	0.75	72	16	8.00	6.30	9	3	7.3	29	E513M8X.75NO7
8	1.00	72	16	8.00	6.30	9	3	7	29	E513M8X1.0NO1
8	1.00	72	16	8.00	6.30	9	3	7	29	E513M8X1.0NO2
8	1.00	72	16	8.00	6.30	9	3	7	29	E513M8X1.0NO3
8	1.00	72	16	8.00	6.30	9	3	7	29	E513M8X1.0NO7
9	0.75	72	16	9.00	7.10	10	3	8.3	29	E513M9X.75NO3
9	1.00	72	16	9.00	7.10	10	3	8	29	E513M9X1.0NO1
9	1.00	72	16	9.00	7.10	10	3	8	29	E513M9X1.0NO2
9	1.00	72	16	9.00	7.10	10	3	8	29	E513M9X1.0NO3

NO1 - NO9
219

MF	P mm	l ₁ mm	l ₂ mm	d ₂ ∅ mm	□ a mm	l ₃ mm	z		l ₄ mm	E513
10	0.50	80	18	10.00	8.00	11	3	9.5	34	E513M10X.5NO3
10	0.75	80	18	10.00	8.00	11	3	9.3	34	E513M10X.75NO1
10	0.75	80	18	10.00	8.00	11	3	9.3	34	E513M10X.75NO2
10	0.75	80	18	10.00	8.00	11	3	9.3	34	E513M10X.75NO3
10	1.00	80	18	10.00	8.00	11	3	9	34	E513M10X1.0NO1
10	1.00	80	18	10.00	8.00	11	3	9	34	E513M10X1.0NO2
10	1.00	80	18	10.00	8.00	11	3	9	34	E513M10X1.0NO3
10	1.00	80	18	10.00	8.00	11	3	9	34	E513M10X1.0NO6
10	1.00	80	18	10.00	8.00	11	3	9	34	E513M10X1.0NO7
10	1.25	80	18	10.00	8.00	11	3	8.8	34	E513M10X1.25NO1
10	1.25	80	18	10.00	8.00	11	3	8.8	34	E513M10X1.25NO2
10	1.25	80	18	10.00	8.00	11	3	8.8	34	E513M10X1.25NO3
10	1.25	80	18	10.00	8.00	11	3	8.8	34	E513M10X1.25NO6
10	1.25	80	18	10.00	8.00	11	3	8.8	34	E513M10X1.25NO7
11	0.75	85	19	8.00	6.30	9	3	10.3	-	E513M11X.75NO1
11	0.75	85	19	8.00	6.30	9	3	10.3	-	E513M11X.75NO2
11	0.75	85	19	8.00	6.30	9	3	10.3	-	E513M11X.75NO3
11	1.00	85	19	8.00	6.30	9	3	10	-	E513M11X1.0NO1
11	1.00	85	19	8.00	6.30	9	3	10	-	E513M11X1.0NO2
11	1.00	85	19	8.00	6.30	9	3	10	-	E513M11X1.0NO3
11	1.25	85	19	8.00	6.30	9	3	9.8	-	E513M11X1.25NO3
12	0.75	89	22	9.00	7.10	10	3	11.3	-	E513M12X.75NO3
12	1.00	89	22	9.00	7.10	10	3	11	-	E513M12X1.0NO1
12	1.00	89	22	9.00	7.10	10	3	11	-	E513M12X1.0NO2
12	1.00	89	22	9.00	7.10	10	3	11	-	E513M12X1.0NO3
12	1.00	89	22	9.00	7.10	10	3	11	-	E513M12X1.0NO7
12	1.25	89	22	9.00	7.10	10	3	10.8	-	E513M12X1.25NO1
12	1.25	89	22	9.00	7.10	10	3	10.8	-	E513M12X1.25NO2
12	1.25	89	22	9.00	7.10	10	3	10.8	-	E513M12X1.25NO3
12	1.25	89	22	9.00	7.10	10	3	10.8	-	E513M12X1.25NO6
12	1.25	89	22	9.00	7.10	10	3	10.8	-	E513M12X1.25NO7
12	1.50	89	22	9.00	7.10	10	3	10.5	-	E513M12X1.5NO1
12	1.50	89	22	9.00	7.10	10	3	10.5	-	E513M12X1.5NO2
12	1.50	89	22	9.00	7.10	10	3	10.5	-	E513M12X1.5NO3
12	1.50	89	22	9.00	7.10	10	3	10.5	-	E513M12X1.5NO6
12	1.50	89	22	9.00	7.10	10	3	10.5	-	E513M12X1.5NO7
13	1.50	89	22	9.00	7.10	10	3	11.5	-	E513M13X1.5NO3
14	1.00	95	24	11.20	9.00	12	4	13	-	E513M14X1.0NO1
14	1.00	95	24	11.20	9.00	12	4	13	-	E513M14X1.0NO2
14	1.00	95	24	11.20	9.00	12	4	13	-	E513M14X1.0NO3
14	1.00	95	24	11.20	9.00	12	4	13	-	E513M14X1.0NO7
14	1.25	95	24	11.20	9.00	12	4	12.8	-	E513M14X1.25NO1
14	1.25	95	24	11.20	9.00	12	4	12.8	-	E513M14X1.25NO2
14	1.25	95	24	11.20	9.00	12	4	12.8	-	E513M14X1.25NO3
14	1.25	95	24	11.20	9.00	12	4	12.8	-	E513M14X1.25NO6
14	1.50	95	24	11.20	9.00	12	4	12.5	-	E513M14X1.5NO1
14	1.50	95	24	11.20	9.00	12	4	12.5	-	E513M14X1.5NO2
14	1.50	95	24	11.20	9.00	12	4	12.5	-	E513M14X1.5NO3
14	1.50	95	24	11.20	9.00	12	4	12.5	-	E513M14X1.5NO6
14	1.50	95	24	11.20	9.00	12	4	12.5	-	E513M14X1.5NO7
15	1.50	95	24	11.20	9.00	12	4	13.5	-	E513M15X1.5NO2
15	1.50	95	24	11.20	9.00	12	4	13.5	-	E513M15X1.5NO3
16	1.00	102	24	12.50	10.00	13	4	15	-	E513M16X1.0NO1
16	1.00	102	24	12.50	10.00	13	4	15	-	E513M16X1.0NO2
16	1.00	102	24	12.50	10.00	13	4	15	-	E513M16X1.0NO3
16	1.00	102	24	12.50	10.00	13	4	15	-	E513M16X1.0NO7
16	1.25	102	24	12.50	10.00	13	4	14.8	-	E513M16X1.25NO3
16	1.50	102	24	12.50	10.00	13	4	14.5	-	E513M16X1.5NO1
16	1.50	102	24	12.50	10.00	13	4	14.5	-	E513M16X1.5NO2
16	1.50	102	24	12.50	10.00	13	4	14.5	-	E513M16X1.5NO3
16	1.50	102	24	12.50	10.00	13	4	14.5	-	E513M16X1.5NO6
16	1.50	102	24	12.50	10.00	13	4	14.5	-	E513M16X1.5NO7
18	1.00	112	29	14.00	11.20	14	4	17	-	E513M18X1.0NO1
18	1.00	112	29	14.00	11.20	14	4	17	-	E513M18X1.0NO2
18	1.00	112	29	14.00	11.20	14	4	17	-	E513M18X1.0NO3
18	1.00	112	29	14.00	11.20	14	4	17	-	E513M18X1.0NO7
18	1.50	112	29	14.00	11.20	14	4	16.5	-	E513M18X1.5NO1
18	1.50	112	29	14.00	11.20	14	4	16.5	-	E513M18X1.5NO2
18	1.50	112	29	14.00	11.20	14	4	16.5	-	E513M18X1.5NO3
18	1.50	112	29	14.00	11.20	14	4	16.5	-	E513M18X1.5NO6

NO1 - NO9
219

MF	P mm	l ₁ mm	l ₂ mm	d ₂ ∅ mm	∇ a mm	l ₃ mm	z		l ₄ mm	E513
18	1.50	112	29	14.00	11.20	14	4	16.5	-	E513M18X1.5NO7
18	2.00	112	29	14.00	11.20	14	4	16	-	E513M18X2.0NO1
18	2.00	112	29	14.00	11.20	14	4	16	-	E513M18X2.0NO2
18	2.00	112	29	14.00	11.20	14	4	16	-	E513M18X2.0NO3
18	2.00	112	29	14.00	11.20	14	4	16	-	E513M18X2.0NO7
20	1.00	112	29	14.00	11.20	14	4	19	-	E513M20X1.0NO1
20	1.00	112	29	14.00	11.20	14	4	19	-	E513M20X1.0NO2
20	1.00	112	29	14.00	11.20	14	4	19	-	E513M20X1.0NO3
20	1.00	112	29	14.00	11.20	14	4	19	-	E513M20X1.0NO7
20	1.50	112	29	14.00	11.20	14	4	18.5	-	E513M20X1.5NO1
20	1.50	112	29	14.00	11.20	14	4	18.5	-	E513M20X1.5NO2
20	1.50	112	29	14.00	11.20	14	4	18.5	-	E513M20X1.5NO3
20	1.50	112	29	14.00	11.20	14	4	18.5	-	E513M20X1.5NO6
20	1.50	112	29	14.00	11.20	14	4	18.5	-	E513M20X1.5NO7
20	2.00	112	29	14.00	11.20	14	4	18	-	E513M20X2.0NO1
20	2.00	112	29	14.00	11.20	14	4	18	-	E513M20X2.0NO2
20	2.00	112	29	14.00	11.20	14	4	18	-	E513M20X2.0NO3
20	2.00	112	29	14.00	11.20	14	4	18	-	E513M20X2.0NO7
22	1.00	118	29	16.00	12.50	16	4	21	-	E513M22X1.0NO2
22	1.00	118	29	16.00	12.50	16	4	21	-	E513M22X1.0NO3
22	1.00	118	29	16.00	12.50	16	4	21	-	E513M22X1.0NO7
22	1.50	118	29	16.00	12.50	16	4	20.5	-	E513M22X1.5NO1
22	1.50	118	29	16.00	12.50	16	4	20.5	-	E513M22X1.5NO2
22	1.50	118	29	16.00	12.50	16	4	20.5	-	E513M22X1.5NO3
22	1.50	118	29	16.00	12.50	16	4	20.5	-	E513M22X1.5NO7
22	2.00	118	29	16.00	12.50	16	4	20	-	E513M22X2.0NO1
22	2.00	118	29	16.00	12.50	16	4	20	-	E513M22X2.0NO2
22	2.00	118	29	16.00	12.50	16	4	20	-	E513M22X2.0NO3
22	2.00	118	29	16.00	12.50	16	4	20	-	E513M22X2.0NO7
24	1.00	130	35	18.00	14.00	18	4	23	-	E513M24X1.0NO2
24	1.00	130	35	18.00	14.00	18	4	23	-	E513M24X1.0NO3
24	1.50	130	35	18.00	14.00	18	4	22.5	-	E513M24X1.5NO1
24	1.50	130	35	18.00	14.00	18	4	22.5	-	E513M24X1.5NO2
24	1.50	130	35	18.00	14.00	18	4	22.5	-	E513M24X1.5NO3
24	1.50	130	35	18.00	14.00	18	4	22.5	-	E513M24X1.5NO7
24	2.00	130	35	18.00	14.00	18	4	22	-	E513M24X2.0NO1
24	2.00	130	35	18.00	14.00	18	4	22	-	E513M24X2.0NO2
24	2.00	130	35	18.00	14.00	18	4	22	-	E513M24X2.0NO3
24	2.00	130	35	18.00	14.00	18	4	22	-	E513M24X2.0NO7
25	1.50	130	35	18.00	14.00	18	4	23.5	-	E513M25X1.5NO1
25	1.50	130	35	18.00	14.00	18	4	23.5	-	E513M25X1.5NO2
25	1.50	130	35	18.00	14.00	18	4	23.5	-	E513M25X1.5NO3
25	1.50	130	35	18.00	14.00	18	4	23.5	-	E513M25X1.5NO6
25	1.50	130	35	18.00	14.00	18	4	23.5	-	E513M25X1.5NO7
26	1.50	130	35	18.00	14.00	18	4	24.5	-	E513M26X1.5NO2
26	1.50	130	35	18.00	14.00	18	4	24.5	-	E513M26X1.5NO3
27	1.50	135	35	20.00	16.00	20	4	25.5	-	E513M27X1.5NO2
27	1.50	135	35	20.00	16.00	20	4	25.5	-	E513M27X1.5NO3
27	2.00	135	35	20.00	16.00	20	4	25	-	E513M27X2.0NO3
28	1.50	138	35	20.00	16.00	20	4	26.5	-	E513M28X1.5NO2
28	1.50	138	35	20.00	16.00	20	4	26.5	-	E513M28X1.5NO3
30	1.50	138	41	20.00	16.00	20	4	28.5	-	E513M30X1.5NO2
30	1.50	138	41	20.00	16.00	20	4	28.5	-	E513M30X1.5NO3
30	2.00	138	41	20.00	16.00	20	4	28	-	E513M30X2.0NO2
30	2.00	138	41	20.00	16.00	20	4	28	-	E513M30X2.0NO3
32	1.50	151	41	22.40	18.00	22	4	30.5	-	E513M32X1.5NO1
32	1.50	151	41	22.40	18.00	22	4	30.5	-	E513M32X1.5NO2
32	1.50	151	41	22.40	18.00	22	4	30.5	-	E513M32X1.5NO3
33	2.00	151	41	22.40	18.00	22	4	31	-	E513M33X2.0NO2
33	2.00	151	41	22.40	18.00	22	4	31	-	E513M33X2.0NO3
35	1.50	162	47	25.00	20.00	24	4	33.5	-	E513M35X1.5NO2
35	1.50	162	47	25.00	20.00	24	4	33.5	-	E513M35X1.5NO3
36	1.50	162	47	25.00	20.00	24	4	34.5	-	E513M36X1.5NO3
36	2.00	162	47	25.00	20.00	24	4	34	-	E513M36X2.0NO2
36	2.00	162	47	25.00	20.00	24	4	34	-	E513M36X2.0NO3
36	3.00	162	47	25.00	20.00	24	4	33	-	E513M36X3.0NO2
36	3.00	162	47	25.00	20.00	24	4	33	-	E513M36X3.0NO3
39	3.00	170	47	28.00	22.40	26	4	36	-	E513M39X3.0NO2
39	3.00	170	47	28.00	22.40	26	4	36	-	E513M39X3.0NO3
40	1.50	170	53	28.00	22.40	26	6	38.5	-	E513M40X1.5NO2

NO1 - NO9
219

MF	P mm	l ₁ mm	l ₂ mm	d ₂ ∅ mm	∇ a mm	l ₃ mm	z		l ₄ mm	E513
40	1.50	170	53	28.00	22.40	26	6	38.5	-	E513M40X1.5NO3
42	1.50	170	53	28.00	22.40	26	6	40.5	-	E513M42X1.5NO2
42	1.50	170	53	28.00	22.40	26	6	40.5	-	E513M42X1.5NO3
42	3.00	170	53	28.00	22.40	26	6	39	-	E513M42X3.0NO3
45	1.50	187	54	31.50	25.00	28	6	43.5	-	E513M45X1.5NO2
45	1.50	187	54	31.50	25.00	28	6	43.5	-	E513M45X1.5NO3
48	1.50	187	60	31.50	25.00	28	6	46.5	-	E513M48X1.5NO3
48	2.00	187	60	31.50	25.00	28	6	46	-	E513M48X2.0NO3
48	3.00	187	60	31.50	25.00	28	6	45	-	E513M48X3.0NO3
50	1.50	187	60	31.50	25.00	28	6	48.5	-	E513M50X1.5NO2
50	1.50	187	60	31.50	25.00	28	6	48.5	-	E513M50X1.5NO3

N01 - N09



219

EP10 EP10TIN EP11

- MF strojní závitník, přímá drážka, lamač Do vyprodání skladu dodáváno v HSS-E
- MF Машинные метчики с подточкой по заборному конусу HSS-E до складирования новой продукции
- MF Gwintownik maszynowy, prosty drobnozwojny Do wyczerpania obecnych zapasów magazynowych dostepny ze stali HSS-E
- MF strojový závitník, priama drážka s lamačom triesok Do vypredania skladu dodávané v HSS-E

EP10	▪	1.1	1.2	1.3	1.4	1.5	6.1	6.3	7.1	7.2	7.3	7.4
	•	1.6	3.1	3.2	3.3	3.4	4.1	4.2	5.1	5.2	6.2	8.1
EP10TIN	▪	1.1	1.2	1.3	1.4	1.5	2.1	2.2	6.1	6.3	7.3	7.4
	•	1.6	2.3	3.1	3.2	3.3	3.4	4.1	4.2	5.1	5.2	6.2
EP11	▪	1.1	1.2	1.3	1.4	1.5						
	•	1.6	2.1	2.2	2.3	3.1	3.2	3.3	3.4			

EP10	MF	DIN 374	6H		2.5XD	HSS-E PM	B 3.5-5				
EP10TIN	MF	DIN 374	6H		2.5XD	HSS-E PM	B 3.5-5			TIN	
EP11	MF	DIN 374	6H		2.5XD	HSS-E PM	B 3.5-5			ST	

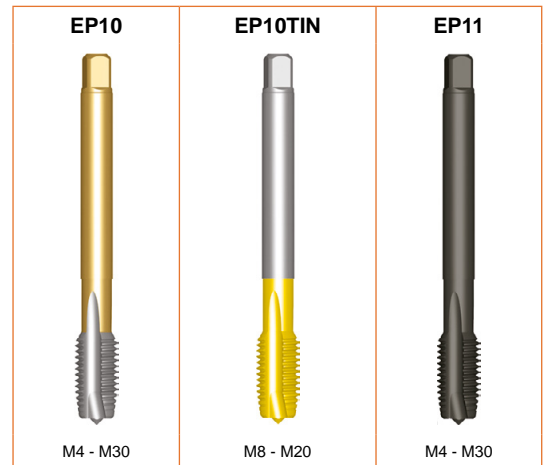
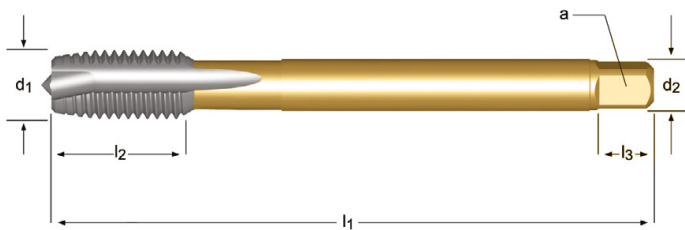

MF	P mm	l ₁ mm	l ₂ mm	d ₂ mm	□ a mm	l ₃ mm	z		EP10	EP10TIN	EP11
4	0.50	63	12	2.8	2.1	5	3	3.5	EP10M4X.5		EP11M4X.5
5	0.50	70	13	3.5	2.7	6	3	4.5	EP10M5X.5		EP11M5X.5
6	0.75	80	15	4.5	3.4	6	3	5.3	EP10M6X.75		EP11M6X.75
8	0.75	80	15	6.0	4.9	8	3	7.3	EP10M8X.75		EP11M8X.75
8	1.00	90	18	6.0	4.9	8	3	7	EP10M8X1.0	EP10TINM8X1.0	EP11M8X1.0
10	0.75	90	18	7.0	5.5	8	3	9.3	EP10M10X.75		EP11M10X.75
10	1.00	90	18	7.0	5.5	8	3	9	EP10M10X1.0	EP10TINM10X1.0	EP11M10X1.0
10	1.25	100	20	7.0	5.5	8	3	8.8	EP10M10X1.25	EP10TINM10X1.25	EP11M10X1.25
12	1.00	100	21	9.0	7.0	10	3	11	EP10M12X1.0	EP10TINM12X1.0	EP11M12X1.0
12	1.25	100	21	9.0	7.0	10	3	10.8	EP10M12X1.25	EP10TINM12X1.25	EP11M12X1.25
12	1.50	100	21	9.0	7.0	10	3	10.5	EP10M12X1.5	EP10TINM12X1.5	EP11M12X1.5
14	1.00	100	21	11.0	9.0	12	3	13	EP10M14X1.0		EP11M14X1.0
14	1.25	100	21	11.0	9.0	12	3	13	EP10M14X1.25		EP11M14X1.25
14	1.50	100	21	11.0	9.0	12	3	12.5	EP10M14X1.5	EP10TINM14X1.5	EP11M14X1.5
16	1.00	100	21	12.0	9.0	12	3	15	EP10M16X1.0		EP11M16X1.0
16	1.50	100	21	12.0	9.0	12	3	14.5	EP10M16X1.5	EP10TINM16X1.5	EP11M16X1.5
18	1.00	110	24	14.0	11.0	14	4	17	EP10M18X1.0		EP11M18X1.0
18	1.50	110	24	14.0	11.0	14	4	16.5	EP10M18X1.5	EP10TINM18X1.5	EP11M18X1.5
20	1.00	125	24	16.0	12.0	15	4	19	EP10M20X1.0		EP11M20X1.0
20	1.50	125	24	16.0	12.0	15	4	18.5	EP10M20X1.5	EP10TINM20X1.5	EP11M20X1.5

MF	P mm	l ₁ mm	l ₂ mm	d ₂ ∅ mm	□ a mm	l ₃ mm	z		EP10	EP10TIN	EP11
22	1.50	125	25	18.0	14.5	17	4	20.5	EP10M22X1.5		EP11M22X1.5
24	1.50	140	28	18.0	14.5	17	4	22.5	EP10M24X1.5		EP11M24X1.5
24	2.00	140	28	18.0	14.5	17	4	22	EP10M24X2.0		EP11M24X2.0
25	1.50	140	28	18.0	14.5	17	4	23.5	EP10M25X1.5		EP11M25X1.5
26	1.50	140	28	18.0	14.5	17	4	24.5	EP10M26X1.5		EP11M26X1.5
27	1.50	140	28	20.0	16.0	19	4	25.5	EP10M27X1.5		EP11M27X1.5
27	2.00	140	28	20.0	16.0	19	4	25	EP10M27X2.0		EP11M27X2.0
28	1.50	140	28	20.0	16.0	19	4	26.5	EP10M28X1.5		EP11M28X1.5
30	1.50	150	28	22.0	18.0	21	4	28.5	EP10M30X1.5		EP11M30X1.5
30	2.00	150	28	22.0	18.0	21	4	28	EP10M30X2.0		EP11M30X2.0

- E299**
- MF strojní závitník s lamačem, žlutý Shark
 - MF Машинный метчик с подточкой по заборному конусу, Yellow Shark
 - MF Gwintownik maszynowy ze skośną powierzchnią natarcia, żółty Shark
 - MF strojový závitník s lamačem, žltý Shark

E299 ■ 1.1 1.2 1.3 6.1 6.3
 • 1.4 1.5 6.2

E299 MF DIN 374 6H 2.5XD HSS-E PM B 3.5-5 Cr

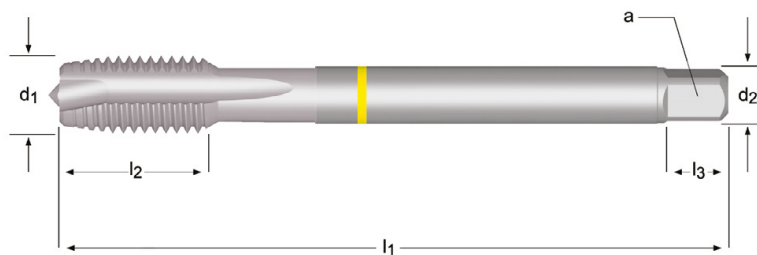

MF	P mm	l ₁ mm	l ₂ mm	d ₂ Ø mm	□ a mm	l ₃ mm	z	↔	E299
4	0.50	63	12	2.8	2.1	5	3	3.5	E299M4X.5
5	0.50	70	13	3.5	2.7	6	3	4.5	E299M5X.5
6	0.75	80	15	4.5	3.4	6	3	5.3	E299M6X.75
8	0.75	80	15	6.0	4.9	8	3	7.3	E299M8X.75
8	1.00	90	18	6.0	4.9	8	3	7.0	E299M8X1.0
10	0.75	90	20	7.0	5.5	8	3	9.3	E299M10X.75
10	1.00	90	20	7.0	5.5	8	3	9.0	E299M10X1.0
10	1.25	100	20	7.0	5.5	8	3	8.8	E299M10X1.25
12	1.00	100	21	9.0	7.0	10	4	11.0	E299M12X1.0
12	1.25	100	21	9.0	7.0	10	4	10.8	E299M12X1.25
12	1.50	110	21	9.0	7.0	10	4	10.5	E299M12X1.5
14	1.00	100	21	11.0	9.0	12	4	13.0	E299M14X1.0
14	1.25	100	21	11.0	9.0	12	4	12.8	E299M14X1.25
14	1.50	100	21	11.0	9.0	12	4	12.5	E299M14X1.5
16	1.00	100	21	12.0	9.0	12	4	15.0	E299M16X1.0
16	1.50	100	21	12.0	9.0	12	4	14.5	E299M16X1.5
18	1.00	110	24	14.0	11.0	14	4	17.0	E299M18X1.0
18	1.50	110	24	14.0	11.0	14	4	16.5	E299M18X1.5
20	1.50	125	24	16.0	12.0	15	4	18.5	E299M20X1.5
22	1.50	125	25	18.0	14.5	17	4	20.5	E299M22X1.5
24	1.50	140	28	18.0	14.5	17	4	22.5	E299M24X1.5
24	2.00	140	28	18.0	14.5	17	4	22.0	E299M24X2.0
27	2.00	140	28	20.0	16.0	19	4	25.0	E299M27X2.0
30	2.00	150	28	22.0	18.0	21	4	28.0	E299M30X2.0

- E384**
- MF strojní závitník s lamačem, modrý Shark
 - MF Машинный метчик с подточкой по заборному конусу, Blue Shark
 - MF Gwintownik maszynowy metryczny drobnozwojny ze skośną powierzchnią natarcia, niebieski Shark
 - MF strojový závitník s lamačom modrý Shark

E384 ■ 2.1 2.2 2.3
 • 1.5

E384 MF DIN 374 6H 2.5XD HSS-E PM B 3.5-5 ST

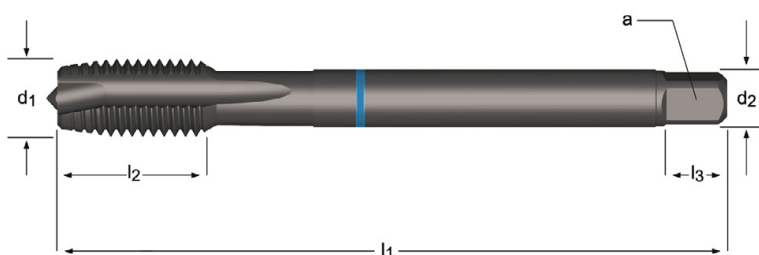

MF	P mm	l ₁ mm	l ₂ mm	d ₂ Ø mm	∠ a mm	l ₃ mm	z	↔	E384
6	0.75	80	15	4.5	3.4	6	3	5.3	E384M6X.75
8	1.00	90	18	6.0	4.9	8	3	7.0	E384M8X1.0
10	1.00	90	20	7.0	5.5	8	3	9.0	E384M10X1.0
10	1.25	100	20	7.0	5.5	8	3	8.8	E384M10X1.25
12	1.00	100	21	9.0	7.0	10	4	11.0	E384M12X1.0
12	1.25	100	21	9.0	7.0	10	4	10.8	E384M12X1.25
12	1.50	100	21	9.0	7.0	10	4	10.5	E384M12X1.5
14	1.50	100	21	11.0	9.0	12	4	12.5	E384M14X1.5
16	1.50	100	21	12.0	9.0	12	5	14.5	E384M16X1.5
18	1.50	110	24	14.0	11.0	14	5	16.5	E384M18X1.5
20	1.50	125	24	16.0	12.0	15	5	18.5	E384M20X1.5

E011

- MF strojní závitník, přímá drážka, lamač
- MF Машинные метчики с подточкой по заборному конусу
- MF Gwintownik maszynowy, prosty rowek wiórowy
- MF strojový závitník, priama drážka s lamačom triesok

Do vyprodání skladu dodáváno v HSS-E
HSS-E до складирования новой продукции
Do wyczerpania obecnych zapasów magazynowych dostepny ze stali HSS-E
Do vypredania skladu dodavane v HSS-E

E011 ■ 1.1 1.2 1.3 1.4 1.5
• 1.6 2.1 2.2 2.3 3.1 3.2 3.3 3.4

E011 MF ISO 529 6H 2.5XD HSS-E PM B 3.5-5 ST

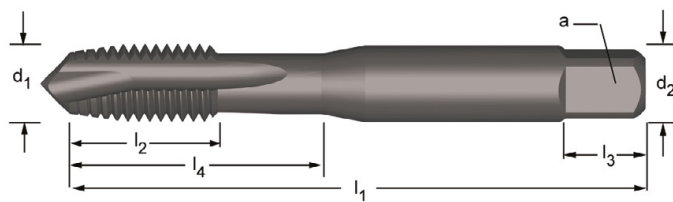

MF	P mm	l ₁ mm	l ₂ mm	d ₂ Ø mm	∠ a mm	l ₃ mm	z	↔	l ₄ mm	E011
4	0.50	53	17	4.0	3.15	6	3	3.5	17	E011M4X.5
5	0.50	58	11	5.0	4.00	7	3	4.5	22	E011M5X.5
6	0.50	66	13	6.3	5.00	8	3	5.5	26	E011M6X.5
6	0.75	66	13	6.3	5.00	8	3	5.3	26	E011M6X.75
8	0.75	72	16	8.0	6.30	9	3	7.3	29	E011M8X.75
8	1.00	72	16	8.0	6.30	9	3	7.0	29	E011M8X1.0
10	1.00	80	18	10.0	8.00	11	3	9.0	34	E011M10X1.0
10	1.25	80	18	10.0	8.00	11	3	8.8	34	E011M10X1.25
12	1.00	89	22	9.0	7.10	10	3	11.0	-	E011M12X1.0
12	1.25	89	22	9.0	7.10	10	3	10.8	-	E011M12X1.25
12	1.50	89	22	9.0	7.10	10	3	10.5	-	E011M12X1.5
14	1.00	95	24	11.2	9.00	12	3	13.0	-	E011M14X1.0
14	1.25	95	24	11.2	9.00	12	3	12.8	-	E011M14X1.25
14	1.50	95	24	11.2	9.00	12	3	12.5	-	E011M14X1.5
16	1.00	102	24	12.5	10.00	13	3	15.0	-	E011M16X1.0
16	1.50	102	24	12.5	10.00	13	3	14.5	-	E011M16X1.5
18	1.00	112	29	14.0	11.20	14	4	17.0	-	E011M18X1.0
18	1.50	112	29	14.0	11.20	14	4	16.5	-	E011M18X1.5
20	1.00	112	29	14.0	11.20	14	4	19.0	-	E011M20X1.0
20	1.50	112	29	14.0	11.20	14	4	18.5	-	E011M20X1.5
20	2.00	112	29	14.0	11.20	14	4	18.0	-	E011M20X2.0
22	1.50	118	29	16.0	12.50	16	4	20.5	-	E011M22X1.5
24	1.50	130	35	18.0	14.00	18	4	22.5	-	E011M24X1.5
24	2.00	130	35	18.0	14.00	18	4	22.0	-	E011M24X2.0

EX10 EX10TIN EX11

- MF strojní závitník, šroubovice 45°
- MF Машинные метчики со спиральной стружечной канавкой 45°
- MF Gwintownik maszynowy skrętny 45°
- MF Strojový závitník, skrutkovica 45°

Do vyprodání skladu dodáváno v HSS-E

HSS-E do skladování nové produkce

Do wyczerpania obecnych zapasów magazynowych dostepny ze stali HSS-E

Do vyprodania skladu dodávané v HSS-E

EX10	▪	1.1	1.2	1.3	1.4	1.5	7.1	7.2	7.3	7.4
	•	4.1	4.2	5.1	5.2					
EX10TIN	▪	1.1	1.2	1.3	1.4	1.5	2.1	2.2	7.3	7.4
	•	2.3	3.1	3.2	3.3	3.4	4.1	4.2	5.1	5.2
EX11	▪	1.1	1.2	1.3	1.4	1.5	2.1	2.2		
	•	2.3								

EX10	MF	DIN 374	6H		2.5XD	HSS-E PM	C 2-3				
EX10TIN	MF	DIN 374	6H		2.5XD	HSS-E PM	C 2-3				
EX11	MF	DIN 374	6H		2.5XD	HSS-E PM	C 2-3				

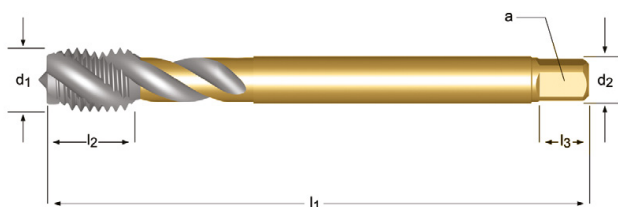

MF	P mm	l ₁ mm	l ₂ mm	d ₂ Ø mm	□ a mm	l ₃ mm	z		EX10	EX10TIN	EX11
4	0.50	63	7	2.8	2.1	5	3	3.5	EX10M4X.50		EX11M4X.50
5	0.50	70	8	3.5	2.7	6	3	4.5	EX10M5X.50		EX11M5X.50
6	0.75	80	10	4.5	3.4	6	3	5.3	EX10M6X.75		EX11M6X.75
8	0.75	80	13	6.0	4.9	8	3	7.3	EX10M8X.75		EX11M8X.75
8	1.00	90	13	6.0	4.9	8	3	7	EX10M8X1.0	EX10TINM8X1.0	EX11M8X1.0
10	0.75	90	13	7.0	5.5	8	3	9.3	EX10M10X.75		EX11M10X.75
10	1.00	90	13	7.0	5.5	8	3	9	EX10M10X1.0	EX10TINM10X1.0	EX11M10X1.0
10	1.25	100	15	7.0	5.5	8	3	8.8	EX10M10X1.25	EX10TINM10X1.25	EX11M10X1.25
12	1.00	100	15	9.0	7.0	10	3	11	EX10M12X1.0	EX10TINM12X1.0	EX11M12X1.0
12	1.25	100	15	9.0	7.0	10	3	10.8	EX10M12X1.25	EX10TINM12X1.25	EX11M12X1.25
12	1.50	100	15	9.0	7.0	10	3	10.5	EX10M12X1.5	EX10TINM12X1.5	EX11M12X1.5
14	1.00	100	15	11.0	9.0	12	3	13	EX10M14X1.0		EX11M14X1.0
14	1.25	100	15	11.0	9.0	12	3	12.8	EX10M14X1.25		EX11M14X1.25
14	1.50	100	15	11.0	9.0	12	3	12.5	EX10M14X1.5	EX10TINM14X1.5	EX11M14X1.5
16	1.00	100	15	12.0	9.0	12	4	15	EX10M16X1.0		EX11M16X1.0
16	1.50	100	15	12.0	9.0	12	4	14.5	EX10M16X1.5	EX10TINM16X1.5	EX11M16X1.5
18	1.00	110	17	14.0	11.0	14	4	17	EX10M18X1.0		EX11M18X1.0
18	1.50	110	17	14.0	11.0	14	4	16.5	EX10M18X1.5	EX10TINM18X1.5	EX11M18X1.5

MF	P mm	l ₁ mm	l ₂ mm	d ₂ ∅ mm	□ a mm	l ₃ mm	z		EX10	EX10TIN	EX11
20	1.00	125	17	16.0	12.0	15	4	19	EX10M20X1.0		EX11M20X1.0
20	1.50	125	17	16.0	12.0	15	4	18.5	EX10M20X1.5	EX10TINM20X1.5	EX11M20X1.5
22	1.50	125	17	18.0	14.5	17	4	20.5	EX10M22X1.5		EX11M22X1.5
24	1.50	140	20	18.0	14.5	17	4	22.5	EX10M24X1.5		EX11M24X1.5
24	2.00	140	20	18.0	14.5	17	4	22	EX10M24X2.0		EX11M24X2.0
25	1.50	140	20	18.0	14.5	17	4	23.5	EX10M25X1.5		EX11M25X1.5
26	1.50	140	20	18.0	14.5	17	4	24.5	EX10M26X1.5		EX11M26X1.5
27	1.50	140	20	20.0	16.0	19	4	25.5	EX10M27X1.5		EX11M27X1.5
27	2.00	140	20	20.0	16.0	19	4	25	EX10M27X2.0		EX11M27X2.0
28	1.50	140	20	20.0	16.0	19	4	26.5	EX10M28X1.5		EX11M28X1.5
30	1.50	150	20	22.0	18.0	21	4	28.5	EX10M30X1.5		EX11M30X1.5
30	2.00	150	20	22.0	18.0	21	4	28	EX10M30X2.0		EX11M30X2.0

- E300**
- MF strojní závitník, šroubovice 40°, žlutý Shark
 - MF Машинный метчик со спиральной стружечной канавкой 40°, Yellow Shark
 - MF Gwintownik maszynowy drobnozwojny metryczny skrzytly 40°, żółty Shark
 - MF strojový závitník, skrutkovica 40°, žltý Shark

E300 ■ 1.1 1.2 1.3 6.1 6.3
 • 1.4 1.5 6.2

E300 MF DIN 374 6H 2XD HSS-E PM C 2-3 λ40° Cr

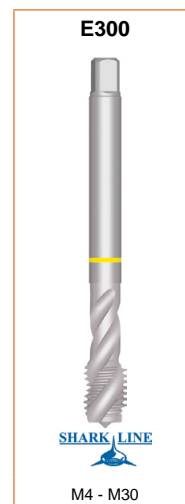
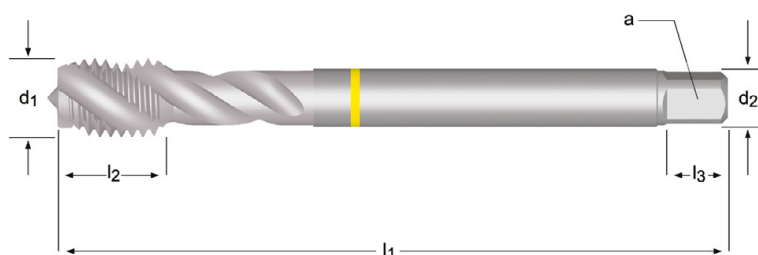

MF	P mm	l ₁ mm	l ₂ mm	d ₂ Ø mm	□ a mm	l ₃ mm	z	↔	E300
4	0.50	63	6.5	2.8	2.1	5	3	3.5	E300M4X.5
5	0.50	70	7.5	3.5	2.7	6	3	4.5	E300M5X.5
6	0.75	80	10	4.5	3.4	6	3	5.3	E300M6X.75
8	0.75	80	13	6.0	4.9	8	3	7.3	E300M8X.75
8	1.00	90	13	6.0	4.9	8	3	7.0	E300M8X1.0
10	0.75	90	13	7.0	5.5	8	3	9.3	E300M10X.75
10	1.00	90	12	7.0	5.5	8	3	9.0	E300M10X1.0
10	1.25	100	15	7.0	5.5	8	3	8.8	E300M10X1.25
12	1.00	100	15	9.0	7.0	10	4	11.0	E300M12X1.0
12	1.25	100	13	9.0	7.0	10	4	10.8	E300M12X1.25
12	1.50	100	13	9.0	7.0	10	4	10.5	E300M12X1.5
14	1.00	100	15	11.0	9.0	12	4	13.0	E300M14X1.0
14	1.25	100	15	11.0	9.0	12	4	12.8	E300M14X1.25
14	1.50	100	15	11.0	9.0	12	4	12.5	E300M14X1.5
16	1.00	100	15	12.0	9.0	12	5	15.0	E300M16X1.0
16	1.50	100	15	12.0	9.0	12	5	14.5	E300M16X1.5
18	1.00	110	17	14.0	11.0	14	5	17.0	E300M18X1.0
18	1.50	110	17	14.0	11.0	14	5	16.5	E300M18X1.5
20	1.50	125	17	16.0	12.0	15	5	18.5	E300M20X1.5
22	1.50	125	17	18.0	14.5	17	5	20.5	E300M22X1.5
24	1.50	140	20	18.0	14.5	17	5	22.5	E300M24X1.5
24	2.00	140	20	18.0	14.5	17	5	22.0	E300M24X2.0
27	2.00	140	20	20.0	16.0	19	5	25.0	E300M27X2.0
30	2.00	150	20	22.0	18.0	21	5	28.0	E300M30X2.0

E383

- MF strojní závitník, šroubovice 40°, modrý Shark
- MF Машинный метчик со спиральной стружечной канавкой 40°, Blue Shark
- MF Gwintownik maszynowy metryczny drobnozwojny skrętny 40°, niebieski Shark
- MF strojový závitník, skrutkovica 40°, modrý Shark

E383 ■ 2.1 2.2 2.3
 • 1.5

E383

MF

DIN
374

6H



2XD

HSS-E
PM

C
2-3



ST

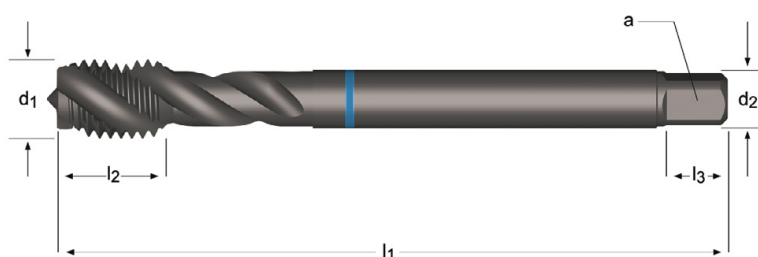

E383



M6 - M20

MF	P mm	l ₁ mm	l ₂ mm	d ₂ mm	□ a mm	l ₃ mm	z		E383
6	0.75	80	10	4.5	3.4	6	3	5.3	E383M6X.75
8	1.00	90	13	6.0	4.9	8	3	7.0	E383M8X1.0
10	1.00	90	12	7.0	5.5	8	3	9.0	E383M10X1.0
10	1.25	100	15	7.0	5.5	8	3	8.8	E383M10X1.25
12	1.00	100	13	9.0	7.0	10	4	11.0	E383M12X1.0
12	1.25	100	13	9.0	7.0	10	4	10.8	E383M12X1.25
12	1.50	100	13	9.0	7.0	10	4	10.5	E383M12X1.5
14	1.50	100	21	11.0	9.0	12	4	12.5	E383M14X1.5
16	1.50	100	21	12.0	9.0	12	5	14.5	E383M16X1.5
18	1.50	110	24	14.0	11.0	14	5	16.5	E383M18X1.5
20	1.50	125	24	16.0	12.0	15	5	18.5	E383M20X1.5

E013

- MF strojní závitník, šroubovice 45°
- MF Машинные метчики со спиральной стружечной канавкой 45°
- MF Gwintownik maszynowy skrętny 45°
- MF Strojový závitník, skrutkovica 45°

Do vyprodání skladu dodáváno v HSS-E
HSS-E до складирования новой продукции
Do wyczerpania obecnych zapasow magazynowych dostepny ze stali HSS-E
Do vypredania skladu dodávané v HSS-E

E013 ■ 1.1 1.2 1.3 1.4 1.5
• 2.1 2.2 2.3

E013 MF ISO 529 6H 2.5XD HSS-E PM C 2-3 λ45° ST

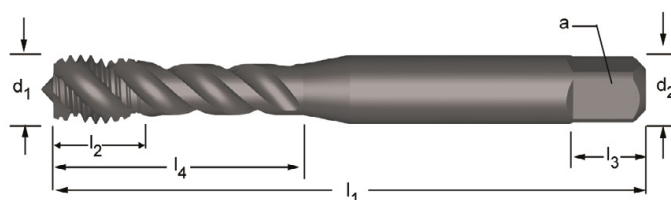

MF	P mm	l ₁ mm	l ₂ mm	d ₂ ∅ mm	∠ a mm	l ₃ mm	z	↔	l ₄ mm	E013
4	0.50	53	7	4.0	3.15	6	3	3.5	19	E013M4X.5
5	0.50	58	8	5.0	4.0	7	3	4.5	22	E013M5X.5
6	0.50	66	10	6.3	5.0	8	3	5.5	27	E013M6X.5
6	0.75	66	10	6.3	5.0	8	3	5.3	27	E013M6X.75
8	0.75	72	12	8.0	6.3	9	3	7.3	31	E013M8X.75
8	1.00	72	12	8.0	6.3	9	3	7.0	31	E013M8X1.0
10	1.00	80	15	10.0	8.0	11	3	9.0	35	E013M10X1.0
10	1.25	80	15	10.0	8.0	11	3	8.8	35	E013M10X1.25
12	1.00	89	16	9.0	7.1	10	3	11.0	-	E013M12X1.0
12	1.25	89	16	9.0	7.1	10	3	10.8	-	E013M12X1.25
12	1.50	89	16	9.0	7.1	10	3	10.5	-	E013M12X1.5
14	1.50	95	18	11.2	9.0	12	3	12.5	-	E013M14X1.5
16	1.00	102	18	12.5	10.0	13	4	15.0	-	E013M16X1.0
16	1.50	102	18	12.5	10.0	13	4	14.5	-	E013M16X1.5
18	1.50	112	29	14.0	11.2	14	4	16.5	-	E013M18X1.5
20	1.50	112	29	14.0	11.2	14	4	18.5	-	E013M20X1.5
22	1.50	118	29	16.0	12.5	16	4	20.5	-	E013M22X1.5

E288

- MF Tvářecí závitník
- MF Метчик-раскатник
- MF Wygniatak maszynowy
- MF strojový tvárnici závitník

E288	▪	1.1	1.2	1.3	1.4	2.1	2.2	4.1	5.1	7.1	7.2	7.3
	•	1.5	2.3	5.2	6.1	6.3	7.4					

E288 MF DIN 2174 6HX 3XD HSS-E C 2-3.5

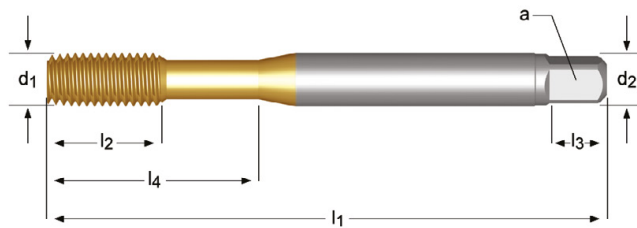

MF	P mm	l ₁ mm	l ₂ mm	d ₂ ∅ mm	a mm	l ₃ mm	z		l ₄ mm	E288
5	0.50	70	13	6.0	4.9	8	5	4.8	25	E288M5X.5
6	0.75	80	15	6.0	4.9	8	5	5.7	30	E288M6X.75
8	1.00	90	18	6.0	4.9	8	5	7.5	-	E288M8X1.0
10	1.00	90	20	7.0	5.5	8	5	9.5	-	E288M10X1.0
10	1.25	100	20	7.0	5.5	8	5	9.4	-	E288M10X1.25
12	1.50	100	21	9.0	7.0	10	5	11.3	-	E288M12X1.5

- E108**
- UNC Závitník ruční, přímá drážka
 - UNC Ручные метчики с прямой стружечной канавкой
 - UNC Gwintownik ręczny, proste rowek wiórowy
 - UNC Závitník ručný, priama drážka

E108 • 1.1 1.2 1.3 1.4 1.5 3.1 3.2 3.3 3.4 6.1 6.2 6.3 6.4 7.2 7.3 7.4 8.2 8.3

E108 UNC DIN 352 2B 1.5XD HSS C 2-3

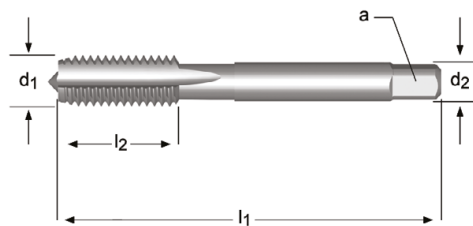

E108



No.5 - 1"

UNC	TPI	d ₁ nom mm	l ₁ mm	l ₂ mm	d ₂ ∅ mm	a mm	z	↔	E108
5	40	3.18	45	13	4.0	3.0	3	2.65	E1085-40NO3
5	40	3.18	45	13	4.0	3.0	3	2.65	E1085-40NO8
6	32	3.51	45	10	4.0	3.0	3	2.85	E1086-32NO3
6	32	3.51	45	10	4.0	3.0	3	2.85	E1086-32NO8
8	32	4.17	50	14	6.0	4.9	3	3.5	E1088-32NO3
8	32	4.17	50	14	6.0	4.9	3	3.5	E1088-32NO8
10	24	4.83	50	14	6.0	4.9	3	3.9	E10810-24NO3
10	24	4.83	50	14	6.0	4.9	3	3.9	E10810-24NO8
12	24	5.49	56	16	6.0	4.9	3	4.5	E10812-24NO3
12	24	5.49	56	16	6.0	4.9	3	4.5	E10812-24NO8
1/4	20	6.35	56	17	6.0	4.9	3	5.1	E1081/4NO3
1/4	20	6.35	56	17	6.0	4.9	3	5.1	E1081/4NO8
5/16	18	7.94	63	19	6.0	4.9	3	6.6	E1085/16NO3
5/16	18	7.94	63	19	6.0	4.9	3	6.6	E1085/16NO8
3/8	16	9.53	70	22	7.0	5.5	3	8	E1083/8NO3
3/8	16	9.53	70	22	7.0	5.5	3	8	E1083/8NO8
7/16	14	11.11	75	30	8.0	6.2	3	9.4	E1087/16NO3
7/16	14	11.11	75	30	8.0	6.2	3	9.4	E1087/16NO8
1/2	13	12.70	75	27	9.0	7.0	3	10.8	E1081/2NO3
1/2	13	12.70	75	27	9.0	7.0	3	10.8	E1081/2NO8
9/16	12	14.29	80	30	11.0	9.0	4	12.2	E1089/16NO3
9/16	12	14.29	80	30	11.0	9.0	4	12.2	E1089/16NO8
5/8	11	15.88	80	32	12.0	9.0	4	13.5	E1085/8NO3
5/8	11	15.88	80	32	12.0	9.0	4	13.5	E1085/8NO8
3/4	10	19.05	95	34	14.0	11.0	4	16.5	E1083/4NO3
3/4	10	19.05	95	34	14.0	11.0	4	16.5	E1083/4NO8
7/8	9	22.23	110	38	18.0	14.5	4	19.5	E1087/8NO3
7/8	9	22.23	110	38	18.0	14.5	4	19.5	E1087/8NO8
1"	8	25.40	110	38	20.0	16.0	4	22.25	E1081NO8

N01 - N09



219

- E225** • UNC strojní závitník
 • UNC Машинные метчики с прямой стружечной канавкой
- E275** • UNC Gwintownik maszynowy, prosty rowek wiórowy
 • UNC strojový závitník

Do vyprodání skladu dodáváno v HSS-E
 HSS-E do складирования новой продукции

Do wyczerpania obecnych zapasów magazynowych dostepny ze stali HSS-E
 Do vypredania skladu dodawane v HSS-E

E225; E275 • 1.1 1.2 1.3 1.4 1.5 3.1 3.2 3.3 6.2 6.3 7.2 7.3 8.2



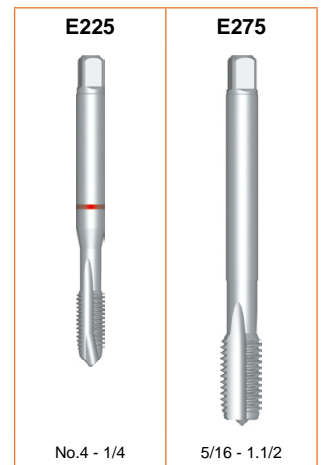
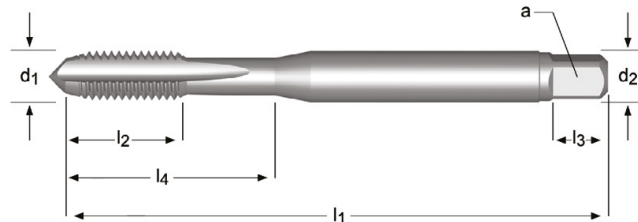

E225	UNC	DIN 371	2B		1.5XD	HSS-E PM	C 2-3				
E275	UNC	DIN 376	2B		1.5XD	HSS-E PM	C 2-3				



UNC	TPI	d ₁ nom mm	l ₁ mm	l ₂ mm	d ₂ Ø mm	∠ a mm	l ₃ mm	z		l ₄ mm	E225	E275
4	40	2.845	56	9	3.5	2.7	6	3	2.35	18	E2254-40	
5	40	3.175	56	10	3.5	2.7	6	3	2.65	18	E2255-40	
6	32	3.505	56	11	4.0	3.0	6	3	2.85	20	E2256-32	
8	32	4.166	63	12	4.5	3.4	8	3	3.5	21	E2258-32	
10	24	4.826	70	13	6.0	4.9	8	3	3.9	25	E22510-24	
12	24	5.486	80	15	6.0	4.9	8	3	4.5	30	E22512-24	
1/4	20	6.350	80	16	7.0	5.5	8	3	5.1	30	E2251/4	
5/16	18	7.94	90	18	6.0	4.9	8	3	6.6			E2755/16
3/8	16	9.53	100	24	7.0	5.5	8	3	8.0			E2753/8
7/16	14	11.11	110	23	9.0	7.0	10	3	9.4			E2757/16
1/2	13	12.7	110	23	9.0	7.0	10	3	10.8			E2751/2
9/16	12	14.29	110	25	11.0	9.0	12	3	12.2			E2759/16
5/8	11	15.88	110	25	12.0	9.0	12	4	13.5			E2755/8
3/4	10	19.05	140	34	14.0	11.0	14	4	16.5			E2753/4
7/8	9	22.23	140	34	18.0	14.5	17	4	19.5			E2757/8
1"	8	25.40	160	38	20.0	16.0	19	4	22.25			E2751
1.1/8	7	28.58	180	45	22.0	18.0	21	4	25.0			E2751.1/8
1.1/4	7	31.75	180	50	25.0	20.0	23	4	28.0			E2751.1/4
1.1/2	6	38.10	200	60	32.0	24.0	27	4	34.0			E2751.1/2

- E515**
- UNC strojní závitník
 - UNC Машинные метчики с прямой стружечной канавкой
 - UNC Gwintownik maszynowy, prosty rowek wiórowy
 - UNC strojový závitník

E515 • 1.1 1.2 1.3 1.4 1.5 3.1 3.2 3.3 3.4 6.1 6.2 6.3 6.4 7.2 7.3 7.4 8.2 8.3

E515 **UNC** **ISO 529** **2B**  **1.5XD** **HSS**      L120 339

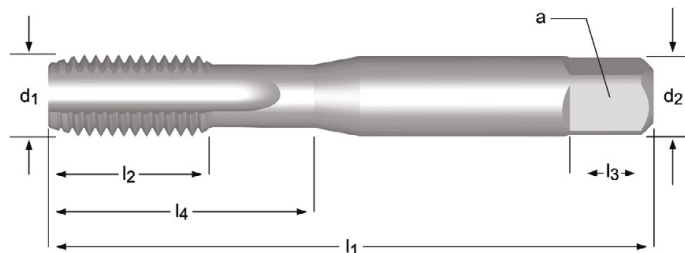

E515



No.1 - 2"

UNC	TPI	d ₁ nom mm	l ₁ mm	l ₂ mm	d ₂ Ø mm	□ a mm	l ₃ mm	z		l ₄ mm	E515
1	64	1.854	41	8	2.50	2.00	4	2	1.55	8	E5151-64NO1
1	64	1.854	41	8	2.50	2.00	4	2	1.55	8	E5151-64NO2
1	64	1.854	41	8	2.50	2.00	4	2	1.55	8	E5151-64NO3
1	64	1.854	41	8	2.50	2.00	4	2	1.55	8	E5151-64NO6
2	56	2.184	44.5	9.5	2.80	2.24	5	3	1.85	9.5	E5152-56NO1
2	56	2.184	44.5	9.5	2.80	2.24	5	3	1.85	9.5	E5152-56NO2
2	56	2.184	44.5	9.5	2.80	2.24	5	3	1.85	9.5	E5152-56NO3
2	56	2.184	44.5	9.5	2.80	2.24	5	3	1.85	9.5	E5152-56NO6
3	48	2.515	44.5	9.5	2.80	2.24	5	3	2.1	9.5	E5153-48NO1
3	48	2.515	44.5	9.5	2.80	2.24	5	3	2.1	9.5	E5153-48NO2
3	48	2.515	44.5	9.5	2.80	2.24	5	3	2.1	9.5	E5153-48NO3
3	48	2.515	44.5	9.5	2.80	2.24	5	3	2.1	9.5	E5153-48NO6
4	40	2.845	48	12.5	3.15	2.50	5	3	2.35	12.5	E5154-40NO1
4	40	2.845	48	12.5	3.15	2.50	5	3	2.35	12.5	E5154-40NO2
4	40	2.845	48	12.5	3.15	2.50	5	3	2.35	12.5	E5154-40NO3
4	40	2.845	48	12.5	3.15	2.50	5	3	2.35	12.5	E5154-40NO6
5	40	3.175	48	12.5	3.15	2.50	5	3	2.65	12.5	E5155-40NO1
5	40	3.175	48	12.5	3.15	2.50	5	3	2.65	12.5	E5155-40NO2
5	40	3.175	48	12.5	3.15	2.50	5	3	2.65	12.5	E5155-40NO3
5	40	3.175	48	12.5	3.15	2.50	5	3	2.65	12.5	E5155-40NO6
6	32	3.505	50	14	3.55	2.80	5	3	2.85	14	E5156-32NO1
6	32	3.505	50	14	3.55	2.80	5	3	2.85	14	E5156-32NO2
6	32	3.505	50	14	3.55	2.80	5	3	2.85	14	E5156-32NO3
6	32	3.505	50	14	3.55	2.80	5	3	2.85	14	E5156-32NO6
8	32	4.166	53	9.5	4.50	3.55	6	3	3.5	17	E5158-32NO1
8	32	4.166	53	9.5	4.50	3.55	6	3	3.5	17	E5158-32NO2
8	32	4.166	53	9.5	4.50	3.55	6	3	3.5	17	E5158-32NO3
8	32	4.166	53	9.5	4.50	3.55	6	3	3.5	17	E5158-32NO6
10	24	4.826	58	11	5.00	4.00	7	3	3.9	20	E51510-24NO1
10	24	4.826	58	11	5.00	4.00	7	3	3.9	20	E51510-24NO2
10	24	4.826	58	11	5.00	4.00	7	3	3.9	20	E51510-24NO3
10	24	4.826	58	11	5.00	4.00	7	3	3.9	20	E51510-24NO6
12	24	5.486	62	12	5.60	4.50	7	3	4.5	21	E51512-24NO1
12	24	5.486	62	12	5.60	4.50	7	3	4.5	21	E51512-24NO2
12	24	5.486	62	12	5.60	4.50	7	3	4.5	21	E51512-24NO3
12	24	5.486	62	12	5.60	4.50	7	3	4.5	21	E51512-24NO6
1/4	20	6.350	66	13	6.30	5.00	8	3	5.1	26	E5151/4NO1
1/4	20	6.350	66	13	6.30	5.00	8	3	5.1	26	E5151/4NO2
1/4	20	6.350	66	13	6.30	5.00	8	3	5.1	26	E5151/4NO3
1/4	20	6.350	66	13	6.30	5.00	8	3	5.1	26	E5151/4NO6
5/16	18	7.938	72	16	8.00	6.30	9	3	6.6	29	E5155/16NO1
5/16	18	7.938	72	16	8.00	6.30	9	3	6.6	29	E5155/16NO2

NO1 - NO9
219

UNC	TPI	d ₁ nom mm	l ₁ mm	l ₂ mm	d ₂ ∅ mm	∠ a mm	l ₃ mm	z		l ₄ mm	E515
5/16	18	7.938	72	16	8.00	6.30	9	3	6.6	29	E5155/16NO3
5/16	18	7.938	72	16	8.00	6.30	9	3	6.6	29	E5155/16NO6
3/8	16	9.525	80	18	10.00	8.00	11	3	8	32	E5153/8NO1
3/8	16	9.525	80	18	10.00	8.00	11	3	8	32	E5153/8NO2
3/8	16	9.525	80	18	10.00	8.00	11	3	8	32	E5153/8NO3
3/8	16	9.525	80	18	10.00	8.00	11	3	8	32	E5153/8NO6
7/16	14	11.112	85	19	8.00	6.30	9	3	9.4	-	E5157/16NO1
7/16	14	11.112	85	19	8.00	6.30	9	3	9.4	-	E5157/16NO2
7/16	14	11.112	85	19	8.00	6.30	9	3	9.4	-	E5157/16NO3
7/16	14	11.112	85	19	8.00	6.30	9	3	9.4	-	E5157/16NO6
1/2	13	12.700	89	22	9.00	7.10	10	3	10.8	-	E5151/2NO1
1/2	13	12.700	89	22	9.00	7.10	10	3	10.8	-	E5151/2NO2
1/2	13	12.700	89	22	9.00	7.10	10	3	10.8	-	E5151/2NO3
1/2	13	12.700	89	22	9.00	7.10	10	3	10.8	-	E5151/2NO6
9/16	12	14.288	95	24	11.20	9.00	12	4	12.2	-	E5159/16NO1
9/16	12	14.288	95	24	11.20	9.00	12	4	12.2	-	E5159/16NO2
9/16	12	14.288	95	24	11.20	9.00	12	4	12.2	-	E5159/16NO3
9/16	12	14.288	95	24	11.20	9.00	12	4	12.2	-	E5159/16NO6
5/8	11	15.875	102	24	12.50	10.00	13	4	13.5	-	E5155/8NO1
5/8	11	15.875	102	24	12.50	10.00	13	4	13.5	-	E5155/8NO2
5/8	11	15.875	102	24	12.50	10.00	13	4	13.5	-	E5155/8NO3
5/8	11	15.875	102	24	12.50	10.00	13	4	13.5	-	E5155/8NO6
3/4	10	19.050	112	29	14.00	11.20	14	4	16.5	-	E5153/4NO1
3/4	10	19.050	112	29	14.00	11.20	14	4	16.5	-	E5153/4NO2
3/4	10	19.050	112	29	14.00	11.20	14	4	16.5	-	E5153/4NO3
3/4	10	19.050	112	29	14.00	11.20	14	4	16.5	-	E5153/4NO6
7/8	9	22.225	118	29	16.00	12.50	16	4	19.5	-	E5157/8NO1
7/8	9	22.225	118	29	16.00	12.50	16	4	19.5	-	E5157/8NO2
7/8	9	22.225	118	29	16.00	12.50	16	4	19.5	-	E5157/8NO3
7/8	9	22.225	118	29	16.00	12.50	16	4	19.5	-	E5157/8NO6
1"	8	25.400	130	35	18.00	14.00	18	4	22.25	-	E5151NO3
1"	8	25.400	130	35	18.00	14.00	18	4	22.25	-	E5151NO1
1"	8	25.400	130	35	18.00	14.00	18	4	22.25	-	E5151NO2
1"	8	25.400	130	35	18.00	14.00	18	4	22.25	-	E5151NO6
1.1/8	7	28.575	138	35	20.00	16.00	20	4	25	-	E5151.1/8NO1
1.1/8	7	28.575	138	35	20.00	16.00	20	4	25	-	E5151.1/8NO2
1.1/8	7	28.575	138	35	20.00	16.00	20	4	25	-	E5151.1/8NO3
1.1/4	7	31.750	151	41	22.40	18.00	22	4	28	-	E5151.1/4NO1
1.1/4	7	31.750	151	41	22.40	18.00	22	4	28	-	E5151.1/4NO2
1.1/4	7	31.750	151	41	22.40	18.00	22	4	28	-	E5151.1/4NO3
1.3/8	6	34.925	162	47	25.00	20.00	24	4	30.75	-	E5151.3/8NO1
1.3/8	6	34.925	162	47	25.00	20.00	24	4	30.75	-	E5151.3/8NO2
1.3/8	6	34.925	162	47	25.00	20.00	24	4	30.75	-	E5151.3/8NO3
1.1/2	6	38.100	170	47	28.00	22.40	26	4	34	-	E5151.1/2NO1
1.1/2	6	38.100	170	47	28.00	22.40	26	4	34	-	E5151.1/2NO2
1.1/2	6	38.100	170	47	28.00	22.40	26	4	34	-	E5151.1/2NO3
1.3/4	5	44.450	187	54	31.50	25.00	28	6	39.5	-	E5151.3/4NO1
1.3/4	5	44.450	187	54	31.50	25.00	28	6	39.5	-	E5151.3/4NO2
1.3/4	5	44.450	187	54	31.50	25.00	28	6	39.5	-	E5151.3/4NO3
2"	4.5	50.800	200	60	35.50	28.00	31	6	45	-	E5152NO3
2"	4.5	50.800	200	60	35.50	28.00	31	6	45	-	E5152NO1
2"	4.5	50.800	200	60	35.50	28.00	31	6	45	-	E5152NO2

NO1 - NO9







219

- EP20**
- UNC strojní závitník, přímá drážka, lamač
 - UNC Машинные метчики с подточкой по заборному конусу
- EP21**
- UNC Gwintownik maszynowy prosty
 - UNC strojový závitník, priama drážka s lamačom triesok

Do vyprodání skladu dodáváno v HSS-E
HSS-E до складирования новой продукции
Do wyczerpania obecnych zapasów magazynowych dostepny ze stali HSS-E
Do vypredania skladu dodávané v HSS-E

EP20	▪	1.1	1.2	1.3	1.4	1.5	6.1	6.3	7.1	7.2	7.3	7.4	
	•	1.6	3.1	3.2	3.3	3.4	4.1	4.2	5.1	5.2	6.2	8.1	
EP21	▪	1.1	1.2	1.3	1.4	1.5							
	•	1.6	2.1	2.2	2.3	3.1	3.2	3.3	3.4				

EP20	UNC	DIN 2184-1	2B		2.5XD	HSS-E PM	B 3.5-5				
EP21	UNC	DIN 2184-1	2B		2.5XD	HSS-E PM	B 3.5-5			 ST	

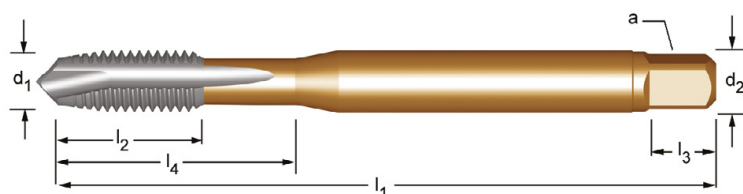

UNC	TPI	d ₁ nom mm	l ₁ mm	l ₂ mm	d ₂ Ø mm	a mm	l ₃ mm	z		l ₄ mm	EP20	EP21
4	40	2.845	56	9	3.5	2.7	6	3	2.35	18	EP204-40	EP214-40
5	40	3.175	56	10	3.5	2.7	6	3	2.65	18	EP205-40	EP215-40
6	32	3.505	56	11	4.0	3.0	6	3	2.85	20	EP206-32	EP216-32
8	32	4.166	63	12	4.5	3.4	8	3	3.5	21	EP208-32	EP218-32
10	24	4.826	70	13	6.0	4.9	8	3	3.9	25	EP210-24	EP2110-24
12	24	5.486	80	15	6.0	4.9	8	3	4.5	30	EP212-24	EP2112-24
1/4	20	6.350	80	15	7.0	5.5	8	3	5.1	30	EP201/4	EP211/4
5/16	18	7.938	90	18	8.0	6.2	9	3	6.6	35	EP205/16	EP215/16
3/8	16	9.525	100	20	10.0	8.0	11	3	8	39	EP203/8	EP213/8
7/16	14	11.112	100	20	8.0	6.2	9	3	9.4	-	EP207/16	EP217/16
1/2	13	12.700	110	23	9.0	7.0	10	3	10.8	-	EP201/2	EP211/2
5/8	11	15.875	110	25	12.0	9.0	12	3	13.5	-	EP205/8	EP215/8
3/4	10	19.050	125	30	14.0	11.0	14	4	16.5	-	EP203/4	EP213/4
7/8	9	22.225	140	34	18.0	14.5	17	4	19.5	-	EP207/8	EP217/8
1"	8	25.400	160	38	18.0	14.5	17	4	22.25	-	EP201	EP211

E021

- UNC strojní závitník, přímá drážka, lamač
- UNC Машинные метчики с подточкой по заборному конусу
- UNC Gwintownik maszynowy prosty
- UNC strojový závitník, priama drážka s lamačom triesok

Do vyprodání skladu dodáváno v HSS-E
HSS-E до складирования новой продукции
Do wyczerpania obecnych zapasów magazynowych dostepny ze stali HSS-E
Do vypredania skladu dodávané v HSS-E

E021 ■ 1.1 1.2 1.3 1.4 1.5
• 1.6 2.1 2.2 2.3 3.1 3.2 3.3 3.4

E021 UNC ISO 529 2B 2.5XD HSS-E PM B 3.5-5 ST

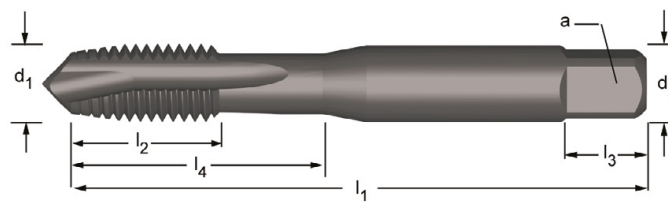

UNC	TPI	d ₁ nom mm	l ₁ mm	l ₂ mm	d ₂ Ø mm	∠ a mm	l ₃ mm	z	↔	l ₄ mm	E021
2	56	2.184	44.5	9.5	2.80	2.24	5	2	1.85	9.5	E0212-56
4	40	2.845	48	14	3.15	2.50	5	3	2.35	14	E0214-40
5	40	3.175	48	12.5	3.15	2.50	5	3	2.65	12.5	E0215-40
6	32	3.505	50	16	3.55	2.80	5	3	2.85	16	E0216-32
8	32	4.166	53	9.5	4.50	3.55	6	3	3.50	17	E0218-32
10	24	4.826	58	11	5.00	4.00	7	3	3.90	20	E02110-24
12	24	5.486	62	12	5.60	4.50	7	3	4.50	21	E02112-24
1/4	20	6.350	66	13	6.30	5.00	8	3	5.10	26	E0211/4
5/16	18	7.938	72	16	8.00	6.30	9	3	6.60	29	E0215/16
3/8	16	9.525	80	18	10.00	8.00	11	3	8.00	32	E0213/8
7/16	14	11.112	85	19	8.00	6.30	9	3	9.40	-	E0217/16
1/2	13	12.700	89	22	9.00	7.10	10	3	10.80	-	E0211/2
5/8	11	15.875	102	24	12.50	10.00	13	3	13.50	-	E0215/8
3/4	10	19.050	112	29	14.00	11.20	14	4	16.50	-	E0213/4
7/8	9	22.225	118	29	16.00	12.50	16	4	19.50	-	E0217/8
1"	8	25.400	130	35	18.00	14.00	18	4	22.25	-	E0211

- EX20**
- UNC strojní závitník, šroubovice 45°
 - UNC Машинные метчики со спиральной стружечной канавкой 45°
- EX21**
- UNC Gwintownik maszynowy skrętny 45°
 - UNC Strojový závitník, skrutkovica 45°

Do vyprodání skladu dodáváno v HSS-E
HSS-E до складирования новой продукции

Do wyczerpania obecnych zapasów magazynowych dostepny ze stali HSS-E
Do vypredania skladu dodávané v HSS-E

EX20 ■ 1.1 1.2 1.3 1.4 1.5 7.1 7.2 7.3 7.4

• 4.1 4.2 5.1 5.2

EX21 ■ 1.1 1.2 1.3 1.4 1.5 2.1 2.2

• 2.3

EX20	UNC	DIN 2184-1	2B		2.5XD	HSS-E PM	C 2-3		$\lambda 45^\circ$			
EX21	UNC	DIN 2184-1	2B		2.5XD	HSS-E PM	C 2-3		$\lambda 45^\circ$		ST	

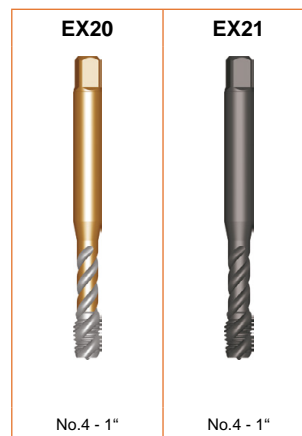
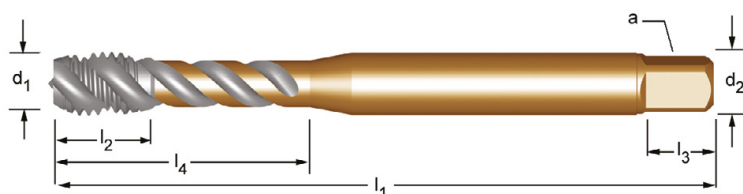

UNC	TPI	d ₁ nom mm	l ₁ mm	l ₂ mm	d ₂ Ø mm	a mm	l ₃ mm	z		l ₄ mm	EX20	EX21
4	40	2.845	56	6	3.5	2.7	6	3	2.35	18	EX204-40	EX214-40
5	40	3.175	56	6	3.5	2.7	6	3	2.65	18	EX205-40	EX215-40
6	32	3.505	56	7	4.0	3.0	6	3	2.85	20	EX206-32	EX216-32
8	32	4.166	63	7	4.5	3.4	8	3	3.5	21	EX208-32	EX218-32
10	24	4.826	70	8	6.0	4.9	8	3	3.9	25	EX2010-24	EX2110-24
12	24	5.486	80	10	6.0	4.9	8	3	4.5	30	EX2012-24	EX2112-24
1/4	20	6.350	80	10	7.0	5.5	8	3	5.1	30	EX201/4	EX211/4
5/16	18	7.938	90	12	8.0	6.2	9	3	6.6	35	EX205/16	EX215/16
3/8	16	9.525	100	15	10.0	8.0	11	3	8.0	39	EX203/8	EX213/8
7/16	14	11.112	100	15	8.0	6.2	9	3	9.4	-	EX207/16	EX217/16
1/2	13	12.700	110	18	9.0	7.0	10	3	10.8	-	EX201/2	EX211/2
5/8	11	15.875	110	20	12.0	9.0	12	4	13.5	-	EX205/8	EX215/8
3/4	10	19.050	125	25	14.0	11.0	14	4	16.5	-	EX203/4	EX213/4
7/8	9	22.225	140	25	18.0	14.5	17	4	19.5	-	EX207/8	EX217/8
1"	8	25.400	160	30	18.0	14.5	17	4	22.25	-	EX201	EX211

- E023**
- UNC strojní závitník, šroubovice 45°
 - UNC Машинные метчики со спиральной стружечной канавкой 45°
 - UNC Gwintownik maszynowy skrętny 45°
 - UNC Strojový závitník, skrutkovica 45°

Do vyprodání skladu dodáváno v HSS-E
HSS-E до складирования новой продукции
Do wyczerpania obecnych zapasów magazynowych dostepny ze stali HSS-E
Do vypredania skladu dodavane v HSS-E

E023 ■ 1.1 1.2 1.3 1.4 1.5
• 2.1 2.2 2.3

E023 UNC ISO 529 2B 2.5XD HSS-E PM C 2-3 λ45° ST

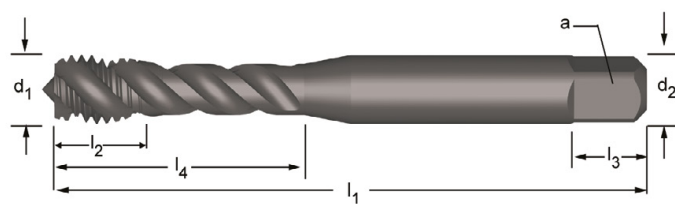

UNC	TPI	d ₁ nom mm	l ₁ mm	l ₂ mm	d ₂ ∅ mm	∠ a mm	l ₃ mm	z	↔	l ₄ mm	E023
2	56	2.184	44.5	9.5	2.80	2.24	5	2	1.85	9.5	E0232-56
4	40	2.845	48	6	3.15	2.50	5	3	2.35	14	E0234-40
5	40	3.175	48	6	3.15	2.50	5	3	2.65	12.5	E0235-40
6	32	3.505	50	6	3.55	2.80	5	3	2.85	16	E0236-32
8	32	4.166	53	7	4.50	3.55	6	3	3.50	17	E0238-32
10	24	4.826	58	8	5.00	4.00	7	3	3.90	20	E02310-24
12	24	5.486	62	12	5.60	4.50	7	3	4.50	21	E02312-24
1/4	20	6.350	66	10	6.30	5.00	8	3	5.10	28	E0231/4
5/16	18	7.938	72	12	8.00	6.30	9	3	6.60	31	E0235/16
3/8	16	9.525	80	15	10.00	8.00	11	3	8.00	34	E0233/8
7/16	14	11.112	85	19	8.00	6.30	9	3	9.40	-	E0237/16
1/2	13	12.700	89	19	9.00	7.10	10	3	10.80	-	E0231/2
5/8	11	15.875	102	24	12.50	10.00	13	4	13.50	-	E0235/8
3/4	10	19.050	112	29	14.00	11.20	14	4	16.50	-	E0233/4
7/8	9	22.225	118	29	16.00	12.50	16	4	19.50	-	E0237/8
1"	8	25.400	130	35	18.00	14.00	18	4	22.25	-	E0231

- E651**
- UNC Závitník kombi
 - UNC Комбинированные метчики со спиральной стружечной канавкой 30°
 - UNC Wiertło/gwintownik skrętny 30°
 - UNC Závitník kombinovaný 30°

E651 • 1.1 1.2 1.3 1.4 3.2 6.2 6.3 7.1 7.2 8.1

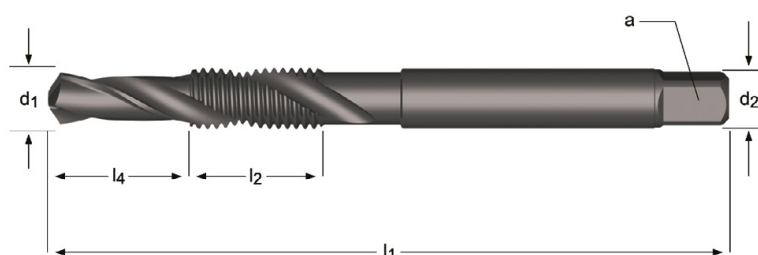

E651



No.6 - 5/8

UNC	TPI	d ₁ nom mm	l ₁ mm	l ₂ mm	l ₄ mm	d ₂ Ø mm	□ a mm	z	E651
6	32	2.85	56.9	12	6.0	3.50	2.90	2	E6516-32
8	32	3.50	64.0	12	8.0	4.50	3.55	2	E6518-32
10	24	3.90	72.0	15	10.0	5.00	4.00	2	E65110-24
12	24	4.50	77.0	15	11.0	5.60	4.50	2	E65112-24
1/4	20	5.10	83.0	17	13.0	6.30	5.00	2	E6511/4
5/16	18	6.60	94.0	21	16.0	8.00	6.30	2	E6515/16
3/8	16	8.00	107.0	23	19.0	10.00	8.00	2	E6513/8
7/16	14	9.40	107.0	25	22.0	8.00	6.30	2	E6517/16
1/2	13	10.80	114.0	29	25.0	9.00	7.10	2	E6511/2
9/16	12	12.20	124.0	29	28.0	11.20	9.00	2	E6519/16
5/8	11	13.50	134.0	31	32.5	12.50	10.00	2	E6515/8

- E287**
- UNC strojní tvářecí závitník s mazacími drážkami
 - UNC Метчик-раскатник с подводом масла
 - UNC Wygniatak maszynowy, z rowkami smarnymi
 - UNC Strojový tvárňiaci závitník s mazacími drážkami

E287	▪	1.1	1.2	1.3	1.4	2.1	2.2	4.1	5.1	7.1	7.2	7.3
	•	1.5	2.3	5.2	6.1	6.3	7.4					

E287 **UNC** **DIN 2184-1** **2BX** **3.5XD** **HSS-E** **C 2-3.5**

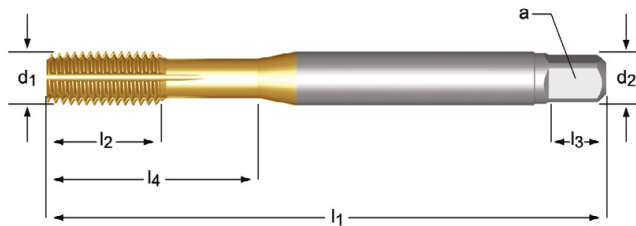

M	TPI	d ₁ nom mm	l ₁ mm	l ₂ mm	d ₂ ∅ mm	□ a mm	l ₃ mm	z		l ₄ mm	E287
4	40	2.845	56	9	3.5	2.7	6	4	2.6	18	E2874-40
6	32	3.505	56	11	4.0	3.0	6	4	3.2	20	E2876-32
8	32	4.166	63	12	4.5	3.4	6	5	3.8	21	E2878-32
10	24	4.826	70	13	6.0	4.9	8	5	4.4	25	E28710-24
1/4	20	6.350	80	15	7.0	5.5	8	5	5.8	30	E2871/4
5/16	18	7.938	90	18	8.0	6.2	9	5	7.3	35	E2875/16
3/8	16	9.525	100	20	10.0	8.0	11	5	8.8	39	E2873/8
7/16	14	11.112	100	20	8.0	6.2	9	5	10.3	-	E2877/16
1/2	13	12.700	110	23	9.0	7.0	10	5	11.9	-	E2871/2

- E111**
- UNF Závitník ruční, přímá drážka
 - UNF Ручные метчики с прямой стружечной канавкой
 - UNF Gwintownik ręczny, prosty rowek wiórowy
 - UNF Závitník ručný, priama drážka

E111 • 1.1 1.2 1.3 1.4 1.5 3.1 3.2 3.3 3.4 6.1 6.2 6.3 6.4 7.2 7.3 7.4 8.2 8.3

E111 UNF DIN 2181 2B 1.5XD HSS C 2-3

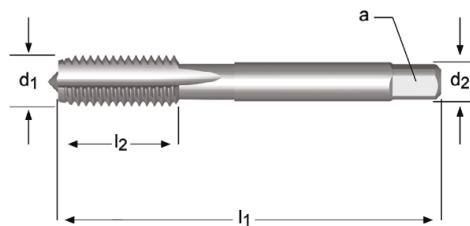

UNF	TPI	d ₁ nom mm	l ₁ mm	l ₂ mm	d ₂ ∅ mm	∟ a mm	z	↔	E111
5	44	3.18	45	13	4.0	3.0	3	2.7	E1115-44NO3
5	44	3.18	45	13	4.0	3.0	3	2.7	E1115-44NO9
6	40	3.51	45	10	4.0	3.0	3	2.95	E1116-40NO3
6	40	3.51	45	10	4.0	3.0	3	2.95	E1116-40NO9
8	36	4.17	50	14	6.0	4.9	3	3.5	E1118-36NO3
8	36	4.17	50	14	6.0	4.9	3	3.5	E1118-36NO9
10	32	4.82	50	14	6.0	4.9	3	4.1	E11110-32NO3
10	32	4.82	50	14	6.0	4.9	3	4.1	E11110-32NO9
1/4	28	6.35	56	17	6.0	4.9	3	5.5	E1111/4NO3
1/4	28	6.35	56	17	6.0	4.9	3	5.5	E1111/4NO9
5/16	24	7.94	63	19	6.0	4.9	3	6.9	E1115/16NO3
5/16	24	7.94	63	19	6.0	4.9	3	6.9	E1115/16NO9
3/8	24	9.53	63	16	7.0	5.5	3	8.5	E1113/8NO3
3/8	24	9.53	63	16	7.0	5.5	3	8.5	E1113/8NO9
7/16	20	11.11	63	15	8.0	6.2	3	9.9	E1117/16NO3
7/16	20	11.11	63	15	8.0	6.2	3	9.9	E1117/16NO9
1/2	20	12.70	70	22	9.0	7.0	3	11.5	E1111/2NO3
1/2	20	12.70	70	22	9.0	7.0	3	11.5	E1111/2NO9
9/16	18	14.29	70	16	11.0	9.0	4	12.9	E1119/16NO3
9/16	18	14.29	70	16	11.0	9.0	4	12.9	E1119/16NO9
5/8	18	15.88	70	16	12.0	9.0	4	14.5	E1115/8NO3
5/8	18	15.88	70	16	12.0	9.0	4	14.5	E1115/8NO9
3/4	16	19.05	80	22	14.0	11.0	4	17.5	E1113/4NO3
3/4	16	19.05	80	22	14.0	11.0	4	17.5	E1113/4NO9
7/8	14	22.23	90	22	18.0	14.5	4	20.4	E1117/8NO3
7/8	14	22.23	90	22	18.0	14.5	4	20.4	E1117/8NO9
1"	12	25.40	90	22	20.0	16.0	4	23.25	E1111NO3
1"	12	25.40	90	22	20.0	16.0	4	23.25	E1111NO9

NO1 - NO9
219

- E229** • UNF strojní závitník
 • UNF Машинные метчики с прямой стружечной канавкой
- E278** • UNF Gwintownik maszynowy, prosty rowek wiórowy
 • UNF Strojový závitník

Do vyprodání skladu dodáváno v HSS-E
 HSS-E до складирования новой продукции

Do wyczerpania obecnych zapasów magazynowych dostepny ze stali HSS-E
 Do vyprodania skladu dodávané v HSS-E

E229; E278 • 1.1 1.2 1.3 1.4 1.5 3.1 3.2 3.3 6.2 6.3 7.2 7.3 8.2

E229	UNF	DIN 371	2B		1.5XD	HSS-E PM	C 2-3				
E278	UNF	DIN 374	2B		1.5XD	HSS-E PM	C 2-3				

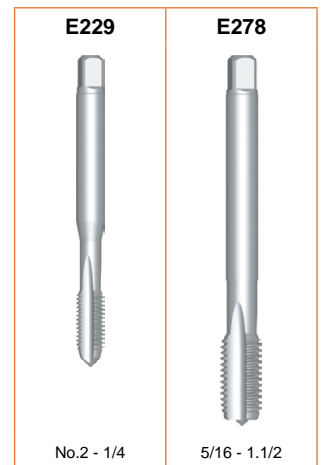
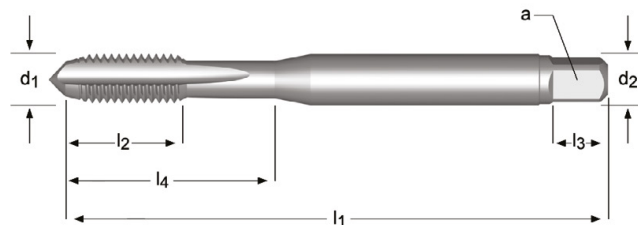

UNF	TPI	d ₁ nom mm	l ₁ mm	l ₂ mm	d ₂ Ø mm	a mm	l ₃ mm	z		l ₄ mm	E229	E278
2	64	2.184	45	7	2.8	2.1	5	3	1.9	12	E2292-64	
3	56	2.515	50	8	2.8	2.1	5	3	2.15	12.5	E2293-56	
4	48	2.845	56	9	3.5	2.7	6	3	2.4	18	E2294-48	
5	44	3.175	56	10	3.5	2.7	6	3	2.7	18	E2295-44	
6	40	3.505	56	11	4.0	3.0	6	3	2.95	20	E2296-40	
8	36	4.166	63	12	4.5	3.4	6	3	3.5	21	E2298-36	
10	32	4.826	70	13	6.0	4.9	8	3	4.1	25	E22910-32	
12	28	5.486	80	15	6.0	4.9	8	3	4.7	30	E22912-28	
1/4	28	6.350	80	15	7.0	5.5	8	3	5.5	30	E2291/4	
5/16	24	7.94	90	18	6.0	4.9	8	3	6.9			E2785/16
3/8	24	9.53	100	24	7.0	5.5	8	3	8.5			E2783/8
7/16	20	11.11	100	22	9.0	7.0	10	3	9.9			E2787/16
1/2	20	12.70	100	21	9.0	7.0	10	3	11.5			E2781/2
9/16	18	14.29	100	21	11.0	9.0	12	4	12.9			E2789/16
5/8	18	15.88	100	21	12.0	9.0	12	4	14.5			E2785/8
3/4	16	19.05	125	25	14.0	11.0	14	4	17.5			E2783/4
7/8	14	22.23	140	28	18.0	14.5	17	4	20.4			E2787/8
1"	12	25.40	140	26	18.0	14.5	17	4	23.25			E2781
1.1/8	12	28.58	150	28	22.0	18.0	21	4	26.5			E2781.1/8
1.1/4	12	31.75	150	28	25.0	20.0	23	4	29.5			E2781.1/4
1.3/8	12	34.93	170	30	28.0	22.0	25	4	32.75			E2781.3/8
1.1/2	12	38.10	170	30	32.0	24.0	27	4	36.0			E2781.1/2 ¹⁾

- E524**
- UNF strojní závitník
 - UNF Машинные метчики с прямой стружечной канавкой
 - UNF Gwintownik maszynowy, prosty rowek wiórowy
 - UNF Strojový závitník

E524 • 1.1 1.2 1.3 1.4 1.5 3.1 3.2 3.3 3.4 6.1 6.2 6.3 6.4 7.2 7.3 7.4 8.2 8.3

E524 UNF ISO 529 2B 1.5XD HSS

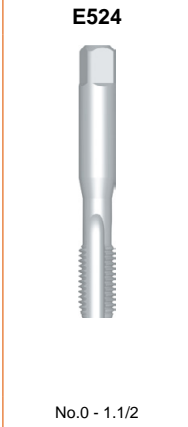
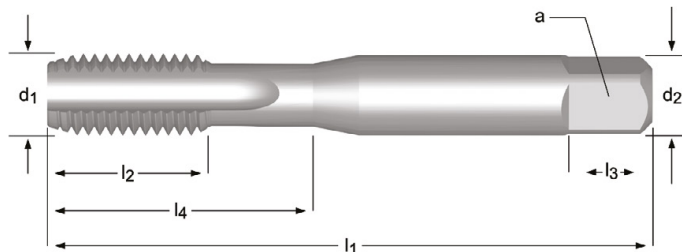

UNF	TPI	d ₁ nom mm	l ₁ mm	l ₂ mm	d ₂ Ø mm	∠ a mm	l ₃ mm	z	↔	l ₄ mm	E524
0	80	1.524	41	7	2.50	2.00	4	2	1.25	7	E5240-80NO1
0	80	1.524	41	7	2.50	2.00	4	2	1.25	7	E5240-80NO2
0	80	1.524	41	7	2.50	2.00	4	2	1.25	7	E5240-80NO3
1	72	1.854	41	8	2.50	2.00	4	2	1.55	8	E5241-72NO1
1	72	1.854	41	8	2.50	2.00	4	2	1.55	8	E5241-72NO2
1	72	1.854	41	8	2.50	2.00	4	2	1.55	8	E5241-72NO3
2	64	2.184	44.5	9.5	2.80	2.24	5	3	1.9	9.5	E5242-64NO1
2	64	2.184	44.5	9.5	2.80	2.24	5	3	1.9	9.5	E5242-64NO2
2	64	2.184	44.5	9.5	2.80	2.24	5	3	1.9	9.5	E5242-64NO3
4	48	2.845	48	12.5	3.15	2.50	5	3	2.4	12.5	E5244-48NO1
4	48	2.845	48	12.5	3.15	2.50	5	3	2.4	12.5	E5244-48NO2
4	48	2.845	48	12.5	3.15	2.50	5	3	2.4	12.5	E5244-48NO3
5	44	3.175	48	12.5	3.15	2.50	5	3	2.7	12.5	E5245-44NO1
5	44	3.175	48	12.5	3.15	2.50	5	3	2.7	12.5	E5245-44NO2
5	44	3.175	48	12.5	3.15	2.50	5	3	2.7	12.5	E5245-44NO3
6	40	3.505	50	14	3.55	2.80	5	3	2.95	14	E5246-40NO1
6	40	3.505	50	14	3.55	2.80	5	3	2.95	14	E5246-40NO2
6	40	3.505	50	14	3.55	2.80	5	3	2.95	14	E5246-40NO3
8	36	4.166	53	9.5	4.50	3.55	6	3	3.5	17	E5248-36NO1
8	36	4.166	53	9.5	4.50	3.55	6	3	3.5	17	E5248-36NO2
8	36	4.166	53	9.5	4.50	3.55	6	3	3.5	17	E5248-36NO3
10	32	4.826	58	11	5.00	4.00	7	3	4.1	20	E52410-32NO1
10	32	4.826	58	11	5.00	4.00	7	3	4.1	20	E52410-32NO2
10	32	4.826	58	11	5.00	4.00	7	3	4.1	20	E52410-32NO3
10	32	4.826	58	11	5.00	4.00	7	3	4.1	20	E52410-32NO6
12	28	5.486	62	12	5.60	4.50	7	3	4.7	21	E52412-28NO1
12	28	5.486	62	12	5.60	4.50	7	3	4.7	21	E52412-28NO2
12	28	5.486	62	12	5.60	4.50	7	3	4.7	21	E52412-28NO3
12	28	5.486	62	12	5.60	4.50	7	3	4.7	21	E52412-28NO6
1/4	28	6.350	66	13	6.30	5.00	8	3	5.5	26	E5241/4NO1
1/4	28	6.350	66	13	6.30	5.00	8	3	5.5	26	E5241/4NO2
1/4	28	6.350	66	13	6.30	5.00	8	3	5.5	26	E5241/4NO3
1/4	28	6.350	66	13	6.30	5.00	8	3	5.5	26	E5241/4NO6
5/16	24	7.938	72	16	8.00	6.30	9	3	6.9	29	E5245/16NO1
5/16	24	7.938	72	16	8.00	6.30	9	3	6.9	29	E5245/16NO2
5/16	24	7.938	72	16	8.00	6.30	9	3	6.9	29	E5245/16NO3
5/16	24	7.938	72	16	8.00	6.30	9	3	6.9	29	E5245/16NO6
3/8	24	9.525	80	18	10.00	8.00	11	3	8.5	32	E5243/8NO1
3/8	24	9.525	80	18	10.00	8.00	11	3	8.5	32	E5243/8NO2
3/8	24	9.525	80	18	10.00	8.00	11	3	8.5	32	E5243/8NO3

NO1 - NO9
219

UNF	TPI	d ₁ nom mm	l ₁ mm	l ₂ mm	d ₂ Ø mm	∠ a mm	l ₃ mm	z		l ₄ mm	E524
3/8	24	9.525	80	18	10.00	8.00	11	3	8.5	32	E5243/8NO6
7/16	20	11.112	85	19	8.00	6.30	9	3	9.9	-	E5247/16NO1
7/16	20	11.112	85	19	8.00	6.30	9	3	9.9	-	E5247/16NO2
7/16	20	11.112	85	19	8.00	6.30	9	3	9.9	-	E5247/16NO3
7/16	20	11.112	85	19	8.00	6.30	9	3	9.9	-	E5247/16NO6
1/2	20	12.700	89	22	9.00	7.10	10	3	11.5	-	E5241/2NO1
1/2	20	12.700	89	22	9.00	7.10	10	3	11.5	-	E5241/2NO2
1/2	20	12.700	89	22	9.00	7.10	10	3	11.5	-	E5241/2NO3
1/2	20	12.700	89	22	9.00	7.10	10	3	11.5	-	E5241/2NO6
9/16	18	14.288	95	24	11.20	9.00	12	4	12.9	-	E5249/16NO1
9/16	18	14.288	95	24	11.20	9.00	12	4	12.9	-	E5249/16NO2
9/16	18	14.288	95	24	11.20	9.00	12	4	12.9	-	E5249/16NO3
9/16	18	14.288	95	24	11.20	9.00	12	4	12.9	-	E5249/16NO6
5/8	18	15.875	102	24	12.50	10.00	13	4	14.5	-	E5245/8NO1
5/8	18	15.875	102	24	12.50	10.00	13	4	14.5	-	E5245/8NO2
5/8	18	15.875	102	24	12.50	10.00	13	4	14.5	-	E5245/8NO3
5/8	18	15.875	102	24	12.50	10.00	13	4	14.5	-	E5245/8NO6
3/4	16	19.050	112	29	14.00	11.20	14	4	17.5	-	E5243/4NO1
3/4	16	19.050	112	29	14.00	11.20	14	4	17.5	-	E5243/4NO2
3/4	16	19.050	112	29	14.00	11.20	14	4	17.5	-	E5243/4NO3
3/4	16	19.050	112	29	14.00	11.20	14	4	17.5	-	E5243/4NO6
7/8	14	22.225	118	29	16.00	12.50	16	4	20.4	-	E5247/8NO1
7/8	14	22.225	118	29	16.00	12.50	16	4	20.4	-	E5247/8NO2
7/8	14	22.225	118	29	16.00	12.50	16	4	20.4	-	E5247/8NO3
7/8	14	22.225	118	29	16.00	12.50	16	4	20.4	-	E5247/8NO6
1"	12	25.400	130	35	18.00	14.00	18	4	23.25	-	E5241NO1
1"	12	25.400	130	35	18.00	14.00	18	4	23.25	-	E5241NO2
1"	12	25.400	130	35	18.00	14.00	18	4	23.25	-	E5241NO3
1"	12	25.400	130	35	18.00	14.00	18	4	23.25	-	E5241NO6
1.1/8	12	28.575	138	35	20.00	16.00	20	4	26.5	-	E5241.1/8NO1
1.1/8	12	28.575	138	35	20.00	16.00	20	4	26.5	-	E5241.1/8NO2
1.1/8	12	28.575	138	35	20.00	16.00	20	4	26.5	-	E5241.1/8NO3
1.1/4	12	31.750	151	41	22.40	18.00	22	4	29.5	-	E5241.1/4NO1
1.1/4	12	31.750	151	41	22.40	18.00	22	4	29.5	-	E5241.1/4NO2
1.1/4	12	31.750	151	41	22.40	18.00	22	4	29.5	-	E5241.1/4NO3
1.3/8	12	34.925	162	47	25.00	20.00	24	4	32.75	-	E5241.3/8NO1
1.3/8	12	34.925	162	47	25.00	20.00	24	4	32.75	-	E5241.3/8NO2
1.3/8	12	34.925	162	47	25.00	20.00	24	4	32.75	-	E5241.3/8NO3
1.1/2	12	38.100	170	47	28.00	22.40	26	4	36	-	E5241.1/2NO1
1.1/2	12	38.100	170	47	28.00	22.40	26	4	36	-	E5241.1/2NO2
1.1/2	12	38.100	170	47	28.00	22.40	26	4	36	-	E5241.1/2NO3

NO1 - NO9



219

EP30

• UNF strojní závitník, přímá drážka, lamač

Do vyprodání skladu dodáváno v HSS-E

EP31

• UNF Машинные метчики с подточкой по заборному конусу
• UNF Gwintownik maszynowy prosty

HSS-E до складирования новой продукции

Do wyczerpania obecnych zapasów magazynowych dostepny ze stali HSS-E

• UNF Strojový závitník, priama drážka s lamačom triesok

Do vypredania skladu dodávané v HSS-E

EP30	▪	1.1	1.2	1.3	1.4	1.5	6.1	6.3	7.1	7.2	7.3	7.4
	•	1.6	3.1	3.2	3.3	3.4	4.1	4.2	5.1	5.2	6.2	8.1

EP31	▪	1.1	1.2	1.3	1.4	1.5			
	•	1.6	2.1	2.2	2.3	3.1	3.2	3.3	3.4

EP30	UNF	DIN 2184-1	2B		2.5XD	HSS-E PM	C 2-3				
EP31	UNF	DIN 2184-1	2B		2.5XD	HSS-E PM	C 2-3			 ST	

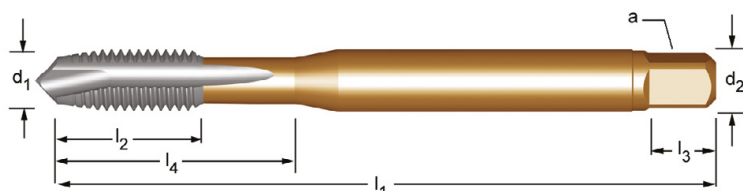

UNF	TPI	d ₁ nom mm	l ₁ mm	l ₂ mm	d ₂ ∅ mm	a mm	l ₃ mm	z		l ₄ mm	EP30	EP31
8	36	4.166	63	12	4.5	3.4	8	3	3.5	21	EP308-36	EP318-36
10	32	4.826	70	13	6.0	4.9	8	3	4.1	25	EP3010-32	EP3110-32
1/4	28	6.350	80	15	7.0	5.5	8	3	5.5	30	EP301/4	EP311/4
5/16	24	7.938	90	18	8.0	6.2	9	3	6.9	35	EP305/16	EP315/16
3/8	24	9.525	100	20	10.0	8.0	11	3	8.5	39	EP303/8	EP313/8
7/16	20	11.112	100	20	8.0	6.2	9	3	9.9	-	EP307/16	EP317/16
1/2	20	12.700	110	23	9.0	7.0	10	3	11.5	-	EP301/2	EP311/2
5/8	18	15.875	110	25	12.0	9.0	12	3	14.5	-	EP305/8	EP315/8
3/4	16	19.050	125	30	14.0	11.0	14	4	17.5	-	EP303/4	EP313/4
7/8	14	22.225	140	34	18.0	14.5	17	4	20.4	-	EP307/8	EP317/8
1"	12	25.400	160	38	18.0	14.5	17	4	23.25	-	EP301	EP311

E031

- UNF strojní závitník, přímá drážka, lamač
 - UNF Машинные метчики с подточкой по заборному конусу
 - UNF Gwintownik maszynowy prosty
 - UNF Strojový závitník, priama drážka s lamačom triesok
- Do vyprodání skladu dodáváno v HSS-E
HSS-E до складирования новой продукции
Do wyczerpania obecnych zapasów magazynowych dostepny ze stali HSS-E
Do vypredania skladu dodávané v HSS-E

E031 ■ 1.1 1.2 1.3 1.4 1.5
• 1.6 2.1 2.2 2.3 3.1 3.2 3.3 3.4

E031 UNF ISO 529 2B 2.5XD HSS-E PM B 3.5-5 ST

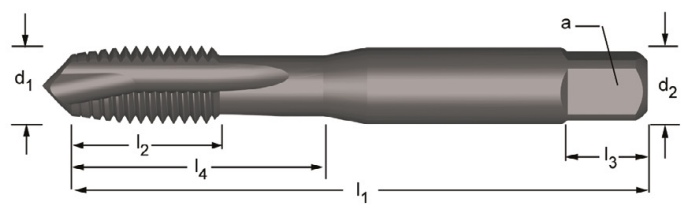

UNF	TPI	d ₁ nom mm	l ₁ mm	l ₂ mm	d ₂ ∅ mm	∠ a mm	l ₃ mm	z	↔	l ₄ mm	E031
8	36	4.166	53	9.5	4.5	3.55	6	3	3.50	17	E0318-36
10	32	4.826	58	11	5.0	4.00	7	3	4.10	20	E03110-32
1/4	28	6.350	66	13	6.3	5.00	8	3	5.50	26	E0311/4
5/16	24	7.938	72	16	8.0	6.30	9	3	6.90	29	E0315/16
3/8	24	9.525	80	18	10.0	8.00	11	3	8.50	32	E0313/8
7/16	20	11.112	85	19	8.0	6.30	9	3	9.90	-	E0317/16
1/2	20	12.700	89	22	9.0	7.10	10	3	11.50	-	E0311/2
9/16	18	14.288	95	24	11.2	9.00	12	3	12.90	-	E0319/16
5/8	18	15.875	102	24	12.5	10.00	13	3	14.50	-	E0315/8
3/4	16	19.050	112	29	14.0	11.20	14	4	17.50	-	E0313/4
7/8	14	22.225	118	29	16.0	12.50	16	4	20.40	-	E0317/8
1"	12	25.400	130	35	18.0	14.00	18	4	23.25	-	E0311

- EX30**
- UNF strojní závitník, šroubovice 45°
 - UNF Машинные метчики со спиральной стружечной канавкой 45°
- EX31**
- UNF Gwintownik maszynowy skrętny 45°
 - UNF Strojový závitník, skrutkovica 45°

Do vyprodání skladu dodáváno v HSS-E
HSS-E до складирования новой продукции
Do wyczerpania obecnych zapasów magazynowych dostepny ze stali HSS-E
Do vypredania skladu dodávané v HSS-E

EX30	▪	1.1	1.2	1.3	1.4	1.5	7.1	7.2	7.3	7.4
	•	4.1	4.2	5.1	5.2					
EX31	▪	1.1	1.2	1.3	1.4	1.5	2.1	2.2		
	•	2.3								

EX30	UNF	DIN 2184-1	2B		2.5XD	HSS-E PM	C 2-3			
EX31	UNF	DIN 2184-1	2B		2.5XD	HSS-E PM	C 2-3			ST

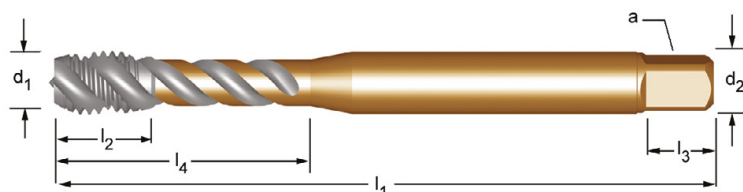

UNF	TPI	d ₁ nom mm	l ₁ mm	l ₂ mm	d ₂ Ø mm	a mm	l ₃ mm	z		l ₄ mm	EX30	EX31
8	36	4.166	63	7	4.5	3.4	8	3	3.5	21	EX308-36	EX318-36
10	32	4.826	70	8	6.0	4.9	8	3	4.1	25	EX3010-32	EX3110-32
1/4	28	6.350	80	10	7.0	5.5	8	3	5.5	30	EX301/4	EX311/4
5/16	24	7.938	90	12	8.0	6.2	9	3	6.9	35	EX305/16	EX315/16
3/8	24	9.525	100	15	10.0	8.0	11	3	8.5	39	EX303/8	EX313/8
7/16	20	11.112	100	15	8.0	6.2	9	3	9.9	-	EX307/16	EX317/16
1/2	20	12.700	110	18	9.0	7.0	10	3	11.5	-	EX301/2	EX311/2
5/8	18	15.875	110	20	12.0	9.0	12	4	14.5	-	EX305/8	EX315/8
3/4	16	19.050	125	25	14.0	11.0	14	4	17.5	-	EX303/4	EX313/4
7/8	14	22.225	140	25	18.0	14.5	17	4	20.4	-	EX307/8	EX317/8
1"	12	25.400	160	30	18.0	14.5	17	4	23.25	-	EX301	EX311

E033

- UNF strojní závitník, šroubovice 45°
- UNF Машинные метчики со спиральной стружечной канавкой 45°
- UNF Gwintownik maszynowy skrętny 45°
- UNF Strojový závitník, skrutkovica 45°

Do vyprodání skladu dodáváno v HSS-E
 HSS-E do складирования новой продукции
 Do wyczerpania obecnych zapasów magazynowych dostepny ze stali HSS-E
 Do vypredania skladu dodavane v HSS-E

E033	▪	1.1	1.2	1.3	1.4	1.5
	•	1.6	2.1	2.2	2.3	

E033 UNF ISO 529 2B 2.5XD HSS-E PM C 2-3 λ45° ST

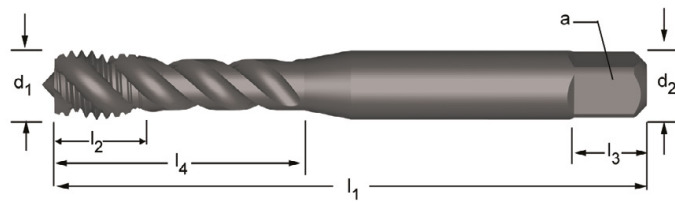

UNF	TPI	d ₁ nom mm	l ₁ mm	l ₂ mm	d ₂ ∅ mm	□ a mm	l ₃ mm	z		l ₄ mm	E033
8	36	4.166	53	7	4.5	3.55	6	3	3.50	17	E0338-36
10	32	4.826	58	8	5.0	4.00	7	3	4.10	20	E03310-32
1/4	28	6.350	66	10	6.3	5.00	8	3	5.50	28	E0331/4
5/16	24	7.938	72	12	8.0	6.30	9	3	6.90	31	E0335/16
3/8	24	9.525	80	15	10.0	8.00	11	3	8.50	34	E0333/8
7/16	20	11.112	85	19	8.0	6.30	9	3	9.90	-	E0337/16
1/2	20	12.700	89	22	9.0	7.10	10	3	11.50	-	E0331/2
9/16	18	14.288	95	24	11.2	9.00	12	3	12.90	-	E0339/16
5/8	18	15.875	102	24	12.5	10.00	13	4	14.50	-	E0335/8
3/4	16	19.050	112	29	14.0	11.20	14	4	17.50	-	E0333/4
7/8	14	22.225	118	29	16.0	12.50	16	4	20.40	-	E0337/8
1"	12	25.400	130	35	18.0	14.00	18	4	23.25	-	E0331

- E654**
- UNF Závitník kombi
 - UNF Комбинированные метчики со спиральной стружечной канавкой 30°
 - UNF Wiertło/gwintownik skrętny 30°
 - UNF Závitník kombinovaný 30°

E654 • 1.1 1.2 1.3 1.4 3.2 6.2 6.3 7.1 7.2 8.1

E654 UNF DORMER DIN Medium 1.5XD HSS C 2-3 λ 30° ST

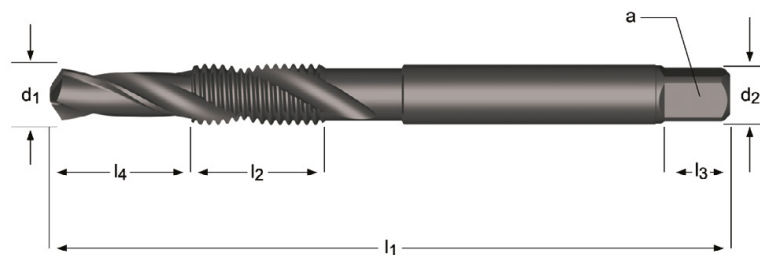

E654



No.8 - 5/8

UNF	TPI	d ₁ nom mm	l ₁ mm	l ₂ mm	l ₄ mm	d ₂ ∅ mm	∠ a mm	z	E654
8	36	3.50	64	13	8	4.5	3.55	2	E6548-36
10	32	4.10	72	16	10	5.0	4.00	2	E65410-32
12	28	4.70	77	17	11	5.6	4.50	2	E65412-28
1/4	28	5.50	83	19	13	6.3	5.00	2	E6541/4
5/16	24	6.90	94	22	16	8.0	6.30	2	E6545/16
3/8	24	8.50	104	24	19	10.0	8.00	2	E6543/8
7/16	20	9.90	107	25	22	8.0	6.30	2	E6547/16
1/2	20	11.50	114	29	25	9.0	7.10	2	E6541/2
5/8	18	14.50	134	32	32	12.5	10.00	2	E6545/8

- E286**
- UNF strojní tvářecí závitník s mazacími drážkami
 - UNF Метчик-раскатник с подводом масла
 - UNF Wygniatak maszynowy z rowkami smarnymi
 - UNF Strojový tvárňiaci závitník s mazacími drážkami

E286	▪	1.1	1.2	1.3	1.4	2.1	2.2	4.1	5.1	7.1	7.2	7.3
	•	1.5	2.3	5.2	6.1	6.3	7.4					

E286 UNF DIN 2184-1 2BX 3.5XD HSS-E C 2-3.5

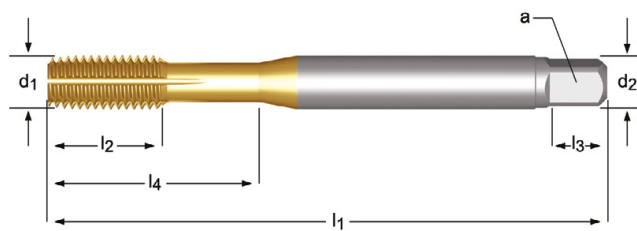

E286



No.4 - 1/2

UNF	TPI	d ₁ nom mm	l ₁ mm	l ₂ mm	d ₂ ∅ mm	a mm	l ₃ mm	z		l ₄ mm	E286
4	48	2.845	56	9	3.5	2.7	6	4	2.6	18	E2864-48
6	40	3.505	56	11	4.0	3.0	6	4	3.2	20	E2866-40
8	36	4.166	63	12	4.5	3.4	6	5	3.9	21	E2868-36
10	32	4.826	70	13	6.0	4.9	8	5	4.5	25	E28610-32
1/4	28	6.350	80	15	7.0	5.5	8	5	6.0	30	E2861/4
5/16	24	7.938	90	18	8.0	6.2	9	5	7.5	35	E2865/16
3/8	24	9.525	100	20	10.0	8.0	11	5	9.1	39	E2863/8
7/16	20	11.112	100	20	8.0	6.2	9	5	10.6	-	E2867/16
1/2	20	12.700	100	21	9.0	7.0	10	5	12.1	-	E2861/2

- E570**
- UN strojní závitník
 - UN Машинные метчики с прямой стружечной канавкой
 - UN Gwintownik maszynowy, prosty rowek wiórowy
 - UN Strojový závitník

E570 • 1.1 1.2 1.3 1.4 1.5 3.1 3.2 3.3 3.4 6.1 6.2 6.3 6.4 7.2 7.3 7.4 8.2 8.3

E570 UN ISO 529 2B 1.5XD HSS C 2-3

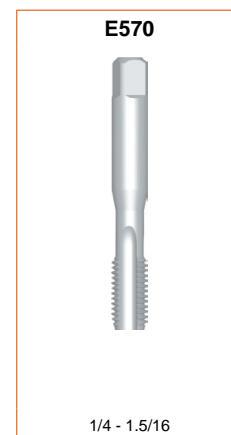
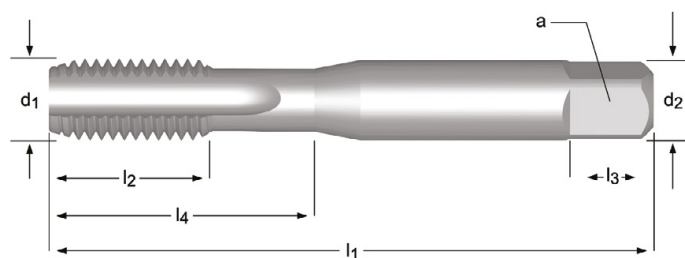

UN	TPI	d ₁ nom mm	l ₁ mm	l ₂ mm	d ₂ ∅ mm	∠ a mm	z		l ₄ mm	E570
1/4	32	6.350	66	13	6.3	5.00	3	5.6	26	E5701/4X32NO3
1/4	36	6.350	66	13	6.3	5.00	3	5.7	26	E5701/4X36NO3
1/4	40	6.350	66	13	6.3	5.00	3	5.7	26	E5701/4X40NO3
5/16	32	7.938	72	16	8.0	6.30	3	7.2	29	E5705/16X32NO3
3/8	32	9.525	80	18	10.0	8.00	3	8.8	32	E5703/8X32NO3
7/16	24	11.112	85	19	8.0	6.30	3	10	-	E5707/16X24NO3
7/16	28	11.112	85	19	8.0	6.30	3	10.2	-	E5707/16X28NO3
1/2	28	12.700	89	22	9.0	7.10	3	11.8	-	E5701/2X28NO3
9/16	24	14.288	95	24	11.2	9.00	4	13.25	-	E5709/16X24NO3
5/8	24	15.875	102	24	12.5	10.00	4	14.8	-	E5705/8X24NO3
3/4	20	19.050	112	29	14.0	11.20	4	17.8	-	E5703/4X20NO3
7/8	20	22.225	118	30	16.0	12.50	4	21	-	E5707/8X20NO3
1"	14	25.400	130	36	18.0	14.00	4	23.5	-	E5701X14NO3
1.1/16	12	26.988	127	37	20.0	16.00	4	24.75	-	E5701.1/16X12NO3
1.1/8	8	28.575	138	35	20.0	16.00	4	25.5	-	E5701.1/8X8NO3
1.3/16	12	30.163	137	37	22.4	18.00	4	28	-	E5701.3/16X12NO3
1.1/4	8	31.750	151	41	22.4	18.00	4	28.5	-	E5701.1/4X8NO3
1.5/16	12	33.338	137	37	22.4	18.00	4	31.25	-	E5701.5/16X12NO3

NO1 - NO9

219

E115

- BSW Závítník ruční, přímá drážka
- BSW Ручные метчики с прямой стружечной канавкой
- BSW Gwintownik ręczny, prosty rowek wiórowy
- BSW Závítník ručný, priama drážka

E115 • 1.1 1.2 1.3 1.4 1.5 3.1 3.2 3.3 3.4 6.1 6.2 6.3 6.4 7.2 7.3 7.4 8.2 8.3

E115 BSW DIN 351 Medium 1.5XD HSS C 2-3    

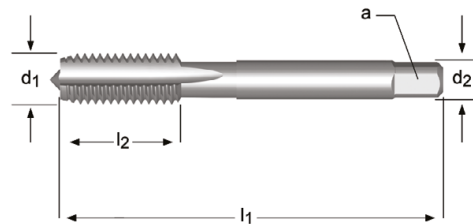

E115



1/8 - 1"

BSW	TPI	d ₁ nom mm	l ₁ mm	l ₂ mm	d ₂ ∅ mm	∠ a mm	z		E115
1/8	40	3.175	40	10	3.5	2.7	3	2.55	E1151/8NO3
1/8	40	3.175	40	10	3.5	2.7	3	2.55	E1151/8NO8
5/32	32	3.969	45	12	4.5	3.4	3	3.2	E1155/32NO3
5/32	32	3.969	45	12	4.5	3.4	3	3.2	E1155/32NO8
3/16	24	4.763	50	16	5.5	4.3	3	3.7	E1153/16NO3
3/16	24	4.763	50	16	5.5	4.3	3	3.7	E1153/16NO8
1/4	20	6.350	56	17	6.0	4.9	3	5.1	E1151/4NO3
1/4	20	6.350	56	17	6.0	4.9	3	5.1	E1151/4NO8
5/16	18	7.938	63	25	6.0	4.9	3	6.5	E1155/16NO3
5/16	18	7.938	63	25	6.0	4.9	3	6.5	E1155/16NO8
3/8	16	9.525	70	22	7.0	5.5	3	7.9	E1153/8NO3
3/8	16	9.525	70	22	7.0	5.5	3	7.9	E1153/8NO8
7/16	14	11.113	75	30	8.0	6.2	3	9.2	E1157/16NO3
7/16	14	11.113	75	30	8.0	6.2	3	9.2	E1157/16NO8
1/2	12	12.700	80	30	9.0	7.0	3	10.5	E1151/2NO3
1/2	12	12.700	80	30	9.0	7.0	3	10.5	E1151/2NO8
9/16	12	14.288	80	30	11.0	9.0	4	12	E1159/16NO3
9/16	12	14.288	80	30	11.0	9.0	4	12	E1159/16NO8
5/8	11	15.875	90	36	12.0	9.0	4	13.5	E1155/8NO3
5/8	11	15.875	90	36	12.0	9.0	4	13.5	E1155/8NO8
3/4	10	19.050	105	40	14.0	11.0	4	16.5	E1153/4NO3
3/4	10	19.050	105	40	14.0	11.0	4	16.5	E1153/4NO8
7/8	9	22.225	110	45	18.0	14.5	4	19.25	E1157/8NO3
7/8	9	22.225	110	45	18.0	14.5	4	19.25	E1157/8NO8
1"	8	25.400	110	50	20.0	16.0	4	22	E1151NO3
1"	8	25.400	110	50	20.0	16.0	4	22	E1151NO8

NO1 - NO9



219

- E531**
- BSW strojní závitník
 - BSW Машинные метчики с прямой стружечной канавкой
 - BSW Gwintownik maszynowy, prosty rowek wiórowy
 - BSW strojový závitník

E531 • 1.1 1.2 1.3 1.4 1.5 3.1 3.2 3.3 3.4 6.1 6.2 6.3 6.4 7.2 7.3 7.4 8.2 8.3

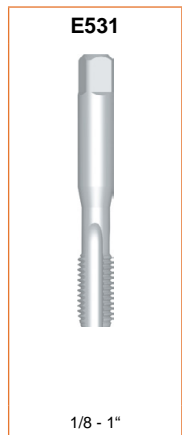
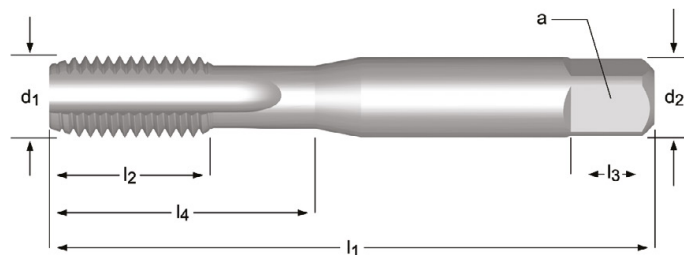

BSW	TPI	d ₁ nom mm	l ₁ mm	l ₂ mm	d ₂ Ø mm	□ a mm	z		l ₄ mm	E531
1/8	40	3.175	48	12.5	3.15	2.50	3	2.55	12.5	E5311/8NO1
1/8	40	3.175	48	12.5	3.15	2.50	3	2.55	12.5	E5311/8NO2
1/8	40	3.175	48	12.5	3.15	2.50	3	2.55	12.5	E5311/8NO3
1/8	40	3.175	48	12.5	3.15	2.50	3	2.55	12.5	E5311/8NO6
5/32	32	3.969	53	14	4.00	3.15	3	3.2	14	E5315/32NO1
5/32	32	3.969	53	14	4.00	3.15	3	3.2	14	E5315/32NO2
5/32	32	3.969	53	14	4.00	3.15	3	3.2	14	E5315/32NO3
5/32	32	3.969	53	14	4.00	3.15	3	3.2	14	E5315/32NO6
3/16	24	4.763	58	11	5.00	4.00	3	3.7	20	E5313/16NO1
3/16	24	4.763	58	11	5.00	4.00	3	3.7	20	E5313/16NO2
3/16	24	4.763	58	11	5.00	4.00	3	3.7	20	E5313/16NO3
3/16	24	4.763	58	11	5.00	4.00	3	3.7	20	E5313/16NO6
1/4	20	6.350	66	13	6.30	5.00	3	5.1	26	E5311/4NO1
1/4	20	6.350	66	13	6.30	5.00	3	5.1	26	E5311/4NO2
1/4	20	6.350	66	13	6.30	5.00	3	5.1	26	E5311/4NO3
1/4	20	6.350	66	13	6.30	5.00	3	5.1	26	E5311/4NO6
5/16	18	7.938	72	16	8.00	6.30	3	6.5	29	E5315/16NO1
5/16	18	7.938	72	16	8.00	6.30	3	6.5	29	E5315/16NO2
5/16	18	7.938	72	16	8.00	6.30	3	6.5	29	E5315/16NO3
5/16	18	7.938	72	16	8.00	6.30	3	6.5	29	E5315/16NO6
3/8	16	9.525	80	18	10.00	8.00	3	7.9	32	E5313/8NO1
3/8	16	9.525	80	18	10.00	8.00	3	7.9	32	E5313/8NO2
3/8	16	9.525	80	18	10.00	8.00	3	7.9	32	E5313/8NO3
3/8	16	9.525	80	18	10.00	8.00	3	7.9	32	E5313/8NO6
7/16	14	11.112	85	19	8.00	6.30	3	9.2	-	E5317/16NO1
7/16	14	11.112	85	19	8.00	6.30	3	9.2	-	E5317/16NO2
7/16	14	11.112	85	19	8.00	6.30	3	9.2	-	E5317/16NO3
7/16	14	11.112	85	19	8.00	6.30	3	9.2	-	E5317/16NO6
1/2	12	12.700	89	22	9.00	7.10	3	10.5	-	E5311/2NO1
1/2	12	12.700	89	22	9.00	7.10	3	10.5	-	E5311/2NO2
1/2	12	12.700	89	22	9.00	7.10	3	10.5	-	E5311/2NO3
1/2	12	12.700	89	22	9.00	7.10	3	10.5	-	E5311/2NO6
5/8	11	15.875	102	24	12.50	10.00	4	13.5	-	E5315/8NO1
5/8	11	15.875	102	24	12.50	10.00	4	13.5	-	E5315/8NO2
5/8	11	15.875	102	24	12.50	10.00	4	13.5	-	E5315/8NO3
5/8	11	15.875	102	24	12.50	10.00	4	13.5	-	E5315/8NO6
3/4	10	19.050	112	29	14.00	11.20	4	16.5	-	E5313/4NO1
3/4	10	19.050	112	29	14.00	11.20	4	16.5	-	E5313/4NO2
3/4	10	19.050	112	29	14.00	11.20	4	16.5	-	E5313/4NO3
3/4	10	19.050	112	29	14.00	11.20	4	16.5	-	E5313/4NO6

NO1 - NO9
219

BSW	TPI	d ₁ nom mm	l ₁ mm	l ₂ mm	d ₂ ∅ mm	∇ a mm	z		l ₄ mm	E531
1"	8	25.400	130	35	18.00	14.00	4	22	-	E5311NO1
1"	8	25.400	130	35	18.00	14.00	4	22	-	E5311NO2
1"	8	25.400	130	35	18.00	14.00	4	22	-	E5311NO3
1"	8	25.400	130	35	18.00	14.00	4	22	-	E5311NO6



E534

- BSW strojní závitník, přímá drážka, lamač
- BSW Машинные метчики с подточкой по заборному конусу
- BSW Gwintownik maszynowy prosty
- BSW Strojový závitník, priama drážka s lamačom triesok

E534	▪	1.1	1.2	1.3	1.4	2.1	2.2	2.3					
	•	1.5	1.6	4.3	5.1	5.2	6.1	6.3	7.1	7.2	7.3	7.4	8.1

E534	BSW	ISO 529	Medium		2.5XD	HSS	B 3.5-5			ST	
------	-----	---------	--------	---	-------	-----	---------	---	---	----	---

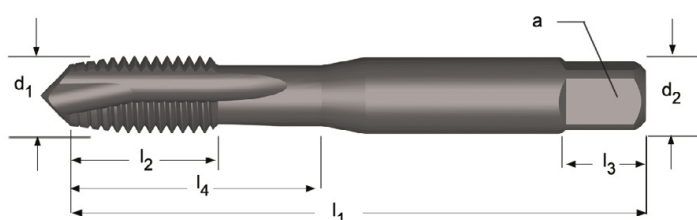

E534



1/8 - 3/4

BSW	TPI	d ₁ nom mm	l ₁ mm	l ₂ mm	d ₂ ∅ mm	a mm	z		l ₄ mm	E534
1/8	40	3.175	48	12.5	3.15	2.50	3	2.55	12.5	E5341/8
5/32	32	3.969	53	14	4.00	3.15	3	3.2	14	E5345/32
3/16	24	4.763	58	11	5.00	4.00	3	3.7	20	E5343/16
1/4	20	6.350	66	13	6.30	5.00	3	5.1	26	E5341/4
5/16	18	7.938	72	16	8.00	6.30	3	6.5	29	E5345/16
3/8	16	9.525	80	18	10.00	8.00	3	7.9	32	E5343/8
7/16	14	11.112	85	19	8.00	6.30	3	9.2	-	E5347/16
1/2	12	12.700	89	22	9.00	7.10	3	10.5	-	E5341/2
5/8	11	15.875	102	24	12.50	10.00	3	13.5	-	E5345/8
3/4	10	19.050	112	29	14.00	11.20	4	16.5	-	E5343/4

- E533**
- BSW strojní závitník, šroubovice 40°
 - BSW Машинные метчики со спиральной стружечной канавкой 40°
 - BSW Gwintownik maszynowy skrętny 40°
 - BSW Strojový závitník, skrutkovica 40°

E533	▪	1.2	1.3	1.4	2.1	2.2	2.3
	•	1.5	5.2	7.1	7.2	7.3	7.4

E533 **BSW** **ISO 529** Medium **2XD** **HSS** **C 2-3** $\lambda 40^\circ$ **ST**

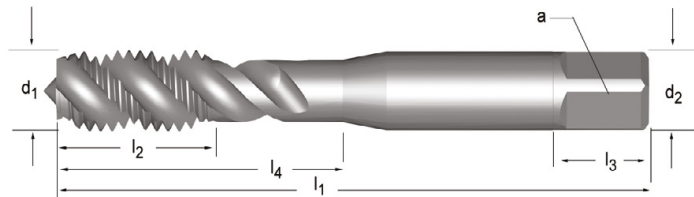

BSW	TPI	d ₁ nom mm	l ₁ mm	l ₂ mm	d ₂ Ø mm	□ a mm	z		l ₄ mm	E533
1/8	40	3.175	48	12.5	3.15	2.50	3	2.55	12.5	E5331/8 ³⁾
1/8	40	3.175	48	12.5	3.15	2.50	3	2.55	12.5	E5331/8BLUE
3/16	24	4.763	58	11	5.00	4.00	3	3.7	20	E5333/16 ³⁾
3/16	24	4.763	58	11	5.00	4.00	3	3.7	20	E5333/16BLUE
1/4	20	6.350	66	13	6.30	5.00	3	5.1	26	E5331/4 ³⁾
1/4	20	6.350	66	13	6.30	5.00	3	5.1	26	E5331/4BLUE
5/16	18	7.938	72	16	8.00	6.30	3	6.5	31	E5335/16 ³⁾
5/16	18	7.938	72	16	8.00	6.30	3	6.5	31	E5335/16BLUE
3/8	16	9.525	80	18	10.00	8.00	3	7.9	34	E5333/8 ³⁾
3/8	16	9.525	80	18	10.00	8.00	3	7.9	34	E5333/8BLUE
1/2	12	12.700	89	22	9.00	7.10	3	10.5	-	E5331/2 ³⁾
1/2	12	12.700	89	22	9.00	7.10	3	10.5	-	E5331/2BLUE
5/8	11	15.875	102	24	12.50	10.00	3	13.5	-	E5335/8 ³⁾
5/8	11	15.875	102	24	12.50	10.00	3	13.5	-	E5335/8BLUE
3/4	10	19.050	112	29	14.00	11.20	3	16.5	-	E5333/4 ³⁾
3/4	10	19.050	112	29	14.00	11.20	3	16.5	-	E5333/4BLUE

³⁾ Broušený / Полированный / Jasny / Brúsený

- E536**
- BSF strojní závitník
 - BSF Машинные метчики с прямой стружечной канавкой
 - BSF Gwintownik maszynowy, prosty rowek wiórowy
 - BSF Strojový závitník

E536 ■ **6.1**

• **1.1 1.2 1.3 1.4 1.5 1.6 2.1 2.2 2.3 3.1 3.2 3.3 3.4 6.2 6.3 6.4 7.2 7.3 7.4 8.2**

8.3

E536 **BSF** **ISO 529** **Medium** **1.5XD** **HSS**

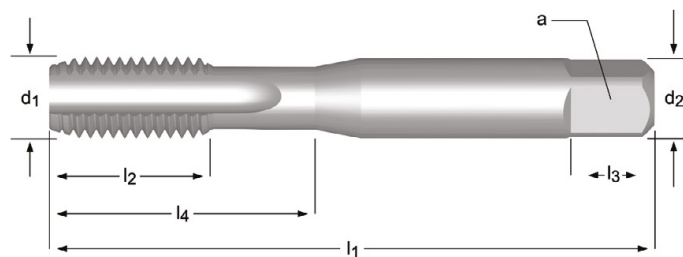

BSF	TPI	d ₁ nom mm	l ₁ mm	l ₂ mm	d ₂ ∅ mm	∇ a mm	z		l ₄ mm	E536
3/16	32	4.76	58	12	5.0	4.0	3	4	20	E5363/16NO1
3/16	32	4.76	58	12	5.0	4.0	3	4	20	E5363/16NO2
3/16	32	4.76	58	12	5.0	4.0	3	4	20	E5363/16NO3
3/16	32	4.76	58	12	5.0	4.0	3	4	20	E5363/16NO6
1/4	26	6.35	66	14	6.3	5.0	3	5.3	26	E5361/4NO1
1/4	26	6.35	66	14	6.3	5.0	3	5.3	26	E5361/4NO2
1/4	26	6.35	66	14	6.3	5.0	3	5.3	26	E5361/4NO3
1/4	26	6.35	66	14	6.3	5.0	3	5.3	26	E5361/4NO6
5/16	22	7.94	72	18	8.0	6.3	3	6.8	29	E5365/16NO1
5/16	22	7.94	72	18	8.0	6.3	3	6.8	29	E5365/16NO2
5/16	22	7.94	72	18	8.0	6.3	3	6.8	29	E5365/16NO3
5/16	22	7.94	72	18	8.0	6.3	3	6.8	29	E5365/16NO6
3/8	20	9.53	80	20	10.0	8.0	3	8.3	32	E5363/8NO1
3/8	20	9.53	80	20	10.0	8.0	3	8.3	32	E5363/8NO2
3/8	20	9.53	80	20	10.0	8.0	3	8.3	32	E5363/8NO3
3/8	20	9.53	80	20	10.0	8.0	3	8.3	32	E5363/8NO6
7/16	18	11.11	85	20	8.0	6.3	3	9.7	-	E5367/16NO1
7/16	18	11.11	85	20	8.0	6.3	3	9.7	-	E5367/16NO2
7/16	18	11.11	85	20	8.0	6.3	3	9.7	-	E5367/16NO3
1/2	16	12.70	89	23	9.0	7.1	3	11	-	E5361/2NO1
1/2	16	12.70	89	23	9.0	7.1	3	11	-	E5361/2NO2
1/2	16	12.70	89	23	9.0	7.1	3	11	-	E5361/2NO3
1/2	16	12.70	89	23	9.0	7.1	3	11	-	E5361/2NO6
9/16	16	14.28	95	25	11.2	9.0	4	12.7	-	E5369/16NO1
9/16	16	14.28	95	25	11.2	9.0	4	12.7	-	E5369/16NO2
9/16	16	14.28	95	25	11.2	9.0	4	12.7	-	E5369/16NO3
5/8	14	15.88	102	25	12.5	10.0	4	14	-	E5365/8NO1
5/8	14	15.88	102	25	12.5	10.0	4	14	-	E5365/8NO2
5/8	14	15.88	102	25	12.5	10.0	4	14	-	E5365/8NO3
3/4	12	19.05	112	30	14.0	11.2	4	17	-	E5363/4NO1
3/4	12	19.05	112	30	14.0	11.2	4	17	-	E5363/4NO2
3/4	12	19.05	112	30	14.0	11.2	4	17	-	E5363/4NO3
7/8	11	22.23	118	30	16.0	12.5	4	19.75	-	E5367/8NO1
7/8	11	22.23	118	30	16.0	12.5	4	19.75	-	E5367/8NO2
7/8	11	22.23	118	30	16.0	12.5	4	19.75	-	E5367/8NO3
7/8	11	22.23	118	30	16.0	12.5	4	19.75	-	E5367/8NO6
1"	10	25.40	130	36	18.0	14.0	4	22.75	-	E5361NO1
1"	10	25.40	130	36	18.0	14.0	4	22.75	-	E5361NO2
1"	10	25.40	130	36	18.0	14.0	4	22.75	-	E5361NO3

NO1 - NO9
219

- E539**
- BSF strojní závitník, přímá drážka, lamač
 - BSF Машинные метчики с подточкой по заборному конусу
 - BSF Gwintownik maszynowy prosty
 - BSF Strojový závitník, priama drážka s lamačom triesok

E539	▪	1.1	1.2	1.3	1.4	2.1	2.2	2.3					
	•	1.5	1.6	4.3	5.1	5.2	6.1	6.3	7.1	7.2	7.3	7.4	8.1

E539 **BSF** **ISO 529** Medium **2.5XD** **HSS** **B 3.5-5** **ST**

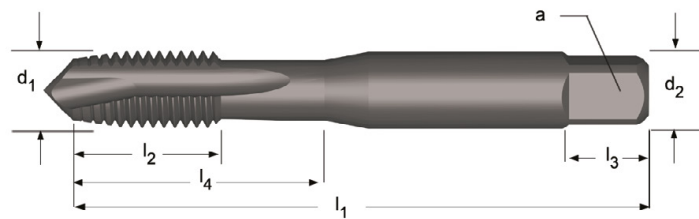

BSF	TPI	d ₁ nom mm	l ₁ mm	l ₂ mm	d ₂ Ø mm	∠ a mm	z		l ₄ mm	E539
1/4	26	6.35	66	14	6.3	5.0	3	5.3	26	E5391/4
5/16	22	7.94	72	18	8.0	6.3	3	6.8	29	E5395/16
3/8	20	9.53	80	20	10.0	8.0	3	8.3	32	E5393/8
1/2	16	12.70	89	23	9.0	7.1	3	11	-	E5391/2

- E538**
- BSF strojní závitník, šroubovice 40°
 - BSF Машинные метчики со спиральной стружечной канавкой 40°
 - BSF Gwintownik maszynowy skrętny 40°
 - BSF Strojový závitník, skrutkovica 40°

E538	▪	1.2	1.3	1.4	2.1	2.2	2.3
	•	1.5	5.2	7.1	7.2	7.3	7.4

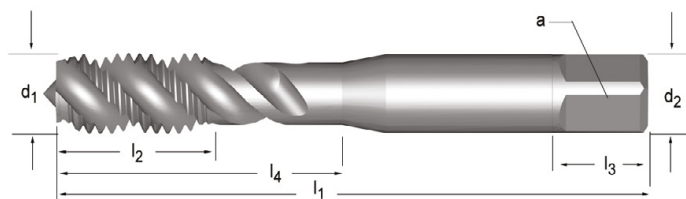
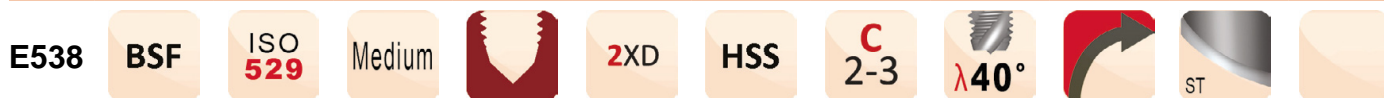

E538



1/4 - 1/2

BSF	TPI	d ₁ nom mm	l ₁ mm	l ₂ mm	d ₂ Ø mm	□ a mm	z		l ₄ mm	E538
1/4	26	6.350	66	13	6.3	5.00	3	5.3	26	E5381/4 ³⁾
1/4	26	6.350	66	13	6.3	5.00	3	5.3	26	E5381/4BLUE
5/16	22	7.938	72	16	8.0	6.30	3	6.8	31	E5385/16 ³⁾
5/16	22	7.938	72	16	8.0	6.30	3	6.8	31	E5385/16BLUE
3/8	20	9.525	80	18	10.0	8.00	3	8.3	34	E5383/8 ³⁾
3/8	20	9.525	80	18	10.0	8.00	3	8.3	34	E5383/8BLUE
1/2	16	12.700	89	22	9.0	7.10	3	11	-	E5381/2 ³⁾
1/2	16	12.700	89	22	9.0	7.10	3	11	-	E5381/2BLUE

- E542**
- BA strojní závitník
 - BA Машинные метчики с прямой стружечной канавкой
 - BA Gwintownik maszynowy, prosty rowek wiórowy
 - BA Strojový závitník

E542 • 1.1 1.2 1.3 1.4 1.5 3.1 3.2 3.3 3.4 6.1 6.2 6.3 6.4 7.2 7.3 7.4 8.2 8.3

E542 BA ISO 529 Normal 1.5XD HSS

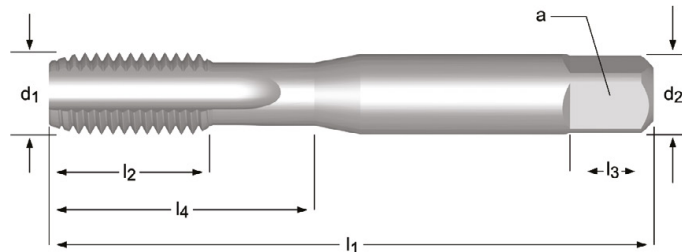

BA	P mm	d ₁ nom mm	l ₁ mm	l ₂ mm	d ₂ Ø mm	∠ a mm	l ₃ mm	z		l ₄ mm	E542
BA10	0.35	1.70	41	7.0	2.50	2.0	4	2	1.3	7	E542BA10NO1
BA10	0.35	1.70	41	7.0	2.50	2.0	4	2	1.3	7	E542BA10NO2
BA10	0.35	1.70	41	7.0	2.50	2.0	4	2	1.3	7	E542BA10NO3
BA10	0.35	1.70	41	7.0	2.50	2.0	4	2	1.3	7	E542BA10NO6
BA 8	0.43	2.20	44.5	9.5	2.80	2.2	5	3	1.8	9.5	E542BA8NO1
BA 8	0.43	2.20	44.5	9.5	2.80	2.2	5	3	1.8	9.5	E542BA8NO2
BA 8	0.43	2.20	44.5	9.5	2.80	2.2	5	3	1.8	9.5	E542BA8NO3
BA 8	0.43	2.20	44.5	9.5	2.80	2.2	5	3	1.8	9.5	E542BA8NO6
BA 6	0.53	2.80	44.5	9.5	2.80	2.2	5	3	2.3	9.5	E542BA6NO1
BA 6	0.53	2.80	44.5	9.5	2.80	2.2	5	3	2.3	9.5	E542BA6NO2
BA 6	0.53	2.80	44.5	9.5	2.80	2.2	5	3	2.3	9.5	E542BA6NO3
BA 6	0.53	2.80	44.5	9.5	2.80	2.2	5	3	2.3	9.5	E542BA6NO6
BA 5	0.59	3.20	48	14.5	3.15	2.5	5	3	2.65	14.5	E542BA5NO1
BA 5	0.59	3.20	48	14.5	3.15	2.5	5	3	2.65	14.5	E542BA5NO2
BA 5	0.59	3.20	48	14.5	3.15	2.5	5	3	2.65	14.5	E542BA5NO3
BA 5	0.59	3.20	48	14.5	3.15	2.5	5	3	2.65	14.5	E542BA5NO6
BA 4	0.66	3.60	50	16.5	3.55	2.8	5	3	3	16.5	E542BA4NO1
BA 4	0.66	3.60	50	16.5	3.55	2.8	5	3	3	16.5	E542BA4NO2
BA 4	0.66	3.60	50	16.5	3.55	2.8	5	3	3	16.5	E542BA4NO3
BA 4	0.66	3.60	50	16.5	3.55	2.8	5	3	3	16.5	E542BA4NO6
BA 3	0.73	4.10	53	10.0	4.50	3.5	6	3	3.4	17	E542BA3NO1
BA 3	0.73	4.10	53	10.0	4.50	3.5	6	3	3.4	17	E542BA3NO2
BA 3	0.73	4.10	53	10.0	4.50	3.5	6	3	3.4	17	E542BA3NO3
BA 3	0.73	4.10	53	10.0	4.50	3.5	6	3	3.4	17	E542BA3NO6
BA 2	0.81	4.70	58	12.0	5.00	4.0	7	3	4	20	E542BA2NO1
BA 2	0.81	4.70	58	12.0	5.00	4.0	7	3	4	20	E542BA2NO2
BA 2	0.81	4.70	58	12.0	5.00	4.0	7	3	4	20	E542BA2NO3
BA 2	0.81	4.70	58	12.0	5.00	4.0	7	3	4	20	E542BA2NO6
BA 0	1.00	6.00	66	14.0	6.30	5.0	8	3	5.1	26	E542BA0NO1
BA 0	1.00	6.00	66	14.0	6.30	5.0	8	3	5.1	26	E542BA0NO2
BA 0	1.00	6.00	66	14.0	6.30	5.0	8	3	5.1	26	E542BA0NO3
BA 0	1.00	6.00	66	14.0	6.30	5.0	8	3	5.1	26	E542BA0NO6

E545

- BA strojní závitník, přímá drážka, lamač
- BA Машинные метчики с подточкой по заборному конусу
- BA Gwintownik maszynowy prosty
- BA Strojový závitník, priama drážka s lamačom triesok

E545	▪	1.1	1.2	1.3	1.4											
	•	1.5	1.6	2.1	2.2	2.3	4.3	5.1	5.2	6.1	6.3	7.1	7.2	7.3	7.4	8.1

E545 **BA** **ISO 529** Normal  **2.5XD** **HSS** **B** 3.5-5    

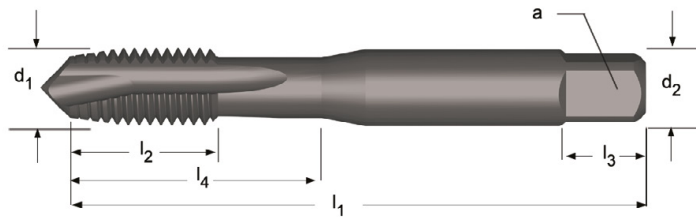

BA	P mm	d ₁ nom mm	l ₁ mm	l ₂ mm	d ₂ Ø mm	∠ a mm	l ₃ mm	z		l ₄ mm	E545
BA10	0.35	1.70	41	7.0	2.50	2.0	4	2	1.3	7	E545BA10
BA 8	0.43	2.20	44.5	9.5	2.80	2.2	5	3	1.8	9.5	E545BA8
BA 6	0.53	2.80	44.5	9.5	2.80	2.2	5	3	2.3	9.5	E545BA6
BA 4	0.66	3.60	50	16.5	3.55	2.8	5	3	3	16.5	E545BA4
BA 2	0.81	4.70	58	12.0	5.00	4.0	7	3	4	20	E545BA2

- E544**
- BA strojní závitník, šroubovice 40°
 - BA Машинные метчики со спиральной стружечной канавкой 40°
 - BA Gwintownik maszynowy skrętny 40°
 - BA Strojový závitník, skrutkovica 40°

E544	▪	1.2	1.3	1.4	2.1	2.2	2.3
	•	1.5	5.2	7.1	7.2	7.3	7.4

E544 **BA** **ISO 529** Normal 2XD **HSS** **C 2-3** $\lambda 40^\circ$

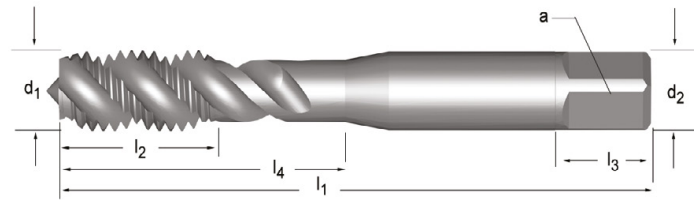

BA	P mm	d ₁ nom mm	l ₁ mm	l ₂ mm	d ₂ Ø mm	□ a mm	l ₃ mm	z		l ₄ mm	E544
BA 8	0.43	2.20	44.5	9.5	2.80	2.2	5	2	1.8	9.5	E544BA8 ³⁾
BA 8	0.43	2.20	44.5	9.5	2.80	2.2	5	2	1.8	9.5	E544BA8BLUE
BA 6	0.53	2.80	44.5	9.5	2.80	2.2	5	2	2.3	9.5	E544BA6 ³⁾
BA 6	0.53	2.80	44.5	9.5	2.80	2.2	5	2	2.3	9.5	E544BA6BLUE
BA 4	0.66	3.60	50	16.5	3.55	2.8	5	3	3	16.5	E544BA4 ³⁾
BA 4	0.66	3.60	50	16.5	3.55	2.8	5	3	3	16.5	E544BA4BLUE
BA 2	0.81	4.70	58	12.0	5.00	4.0	7	3	4	20	E544BA2 ³⁾
BA 2	0.81	4.70	58	12.0	5.00	4.0	7	3	4	20	E544BA2BLUE

³⁾ Broušený / Полированный / Jasny / Brúsený

- E119**
- G(BSP) Závítník ruční, přímá drážka
 - G(BSP) Ручные метчики с прямой стружечной канавкой
 - G(BSP) Gwintownik ręczny, prosty rowek wiórowy
 - G(BSP) Závítník ručný, priama drážka

E119 • 1.1 1.2 1.3 1.4 1.5 3.1 3.2 3.3 3.4 6.1 6.2 6.3 6.4 7.2 7.3 7.4 8.2 8.3

E119 **G** **DIN 5157** Normal  **1.5XD** **HSS** **C 2-3**    

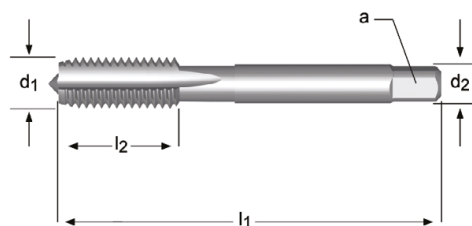

G(BSP)	TPI	d ₁ nom mm	l ₁ mm	l ₂ mm	d ₂ Ø mm	∩ a mm	z		E119
1/8	28	9.73	63	15	7.0	5.5	3	8.8	E1191/8NO3
1/8	28	9.73	63	15	7.0	5.5	3	8.8	E1191/8NO9
1/4	19	13.16	70	16	11.0	9.0	4	11.8	E1191/4NO3
1/4	19	13.16	70	16	11.0	9.0	4	11.8	E1191/4NO9
3/8	19	16.66	70	16	12.0	9.0	4	15.25	E1193/8NO3
3/8	19	16.66	70	16	12.0	9.0	4	15.25	E1193/8NO9
1/2	14	20.96	80	18	16.0	12.0	4	19	E1191/2NO3
1/2	14	20.96	80	18	16.0	12.0	4	19	E1191/2NO9
5/8	14	22.91	80	22	18.0	14.5	4	21	E1195/8NO3
5/8	14	22.91	80	22	18.0	14.5	4	21	E1195/8NO9
3/4	14	26.44	90	22	20.0	16.0	4	24.5	E1193/4NO3
3/4	14	26.44	90	22	20.0	16.0	4	24.5	E1193/4NO9
7/8	14	30.20	90	22	22.0	18.0	6	28.25	E1197/8NO3
7/8	14	30.20	90	22	22.0	18.0	6	28.25	E1197/8NO9
1"	11	33.25	100	25	25.0	20.0	6	30.75	E1191NO3
1"	11	33.25	100	25	25.0	20.0	6	30.75	E1191NO9
1.1/8	11	37.90	125	40	28.0	22.0	6	35	E1191.1/8NO3
1.1/8	11	37.90	125	40	28.0	22.0	6	35	E1191.1/8NO9
1.1/4	11	41.91	125	40	32.0	24.0	6	39.5	E1191.1/4NO3
1.1/4	11	41.91	125	40	32.0	24.0	6	39.5	E1191.1/4NO9
1.1/2	11	47.80	140	40	36.0	29.0	6	45	E1191.1/2NO3
1.1/2	11	47.80	140	40	36.0	29.0	6	45	E1191.1/2NO9
1.3/4	11	53.75	140	40	40.0	32.0	6	51	E1191.3/4NO3
1.3/4	11	53.75	140	40	40.0	32.0	6	51	E1191.3/4NO9
2"	11	59.61	160	40	45.0	35.0	6	57	E1192NO3
2"	11	59.61	160	40	45.0	35.0	6	57	E1192NO9
2.1/4	11	65.71	160	40	50.0	39.0	6	63	E1192.1/4NO3
2.1/4	11	65.71	160	40	50.0	39.0	6	63	E1192.1/4NO9
2.1/2	11	75.18	160	40	50.0	39.0	6	72.5	E1192.1/2NO3
2.1/2	11	75.18	160	40	50.0	39.0	6	72.5	E1192.1/2NO9
2.3/4	11	81.53	160	40	50.0	39.0	8	79	E1192.3/4NO3
2.3/4	11	81.53	160	40	50.0	39.0	8	79	E1192.3/4NO9
3"	11	87.88	160	40	50.0	39.0	8	85.5	E1193NO3
3"	11	87.88	160	40	50.0	39.0	8	85.5	E1193NO9

NO1 - NO9



219

E282

- G(BSP) strojní závitník
- G(BSP) Машинные метчики с прямой стружечной канавкой
- G(BSP) Gwintownik maszynowy, prosty rowek wiórowy
- G(BSP) Strojový závitník

Do vyprodání skladu dodáváno v HSS-E
HSS-E до складирования новой продукции
Do wyczerpania obecnych zapasów magazynowych dostepny ze stali HSS-E
Do vypredania skladu dodávané v HSS-E

E282 • 1.1 1.2 1.3 1.4 1.5 3.1 3.2 3.3 6.2 6.3 7.2 7.3 8.2

E282 G DIN 5156 Normal 1.5XD HSS-E PM C 2-3

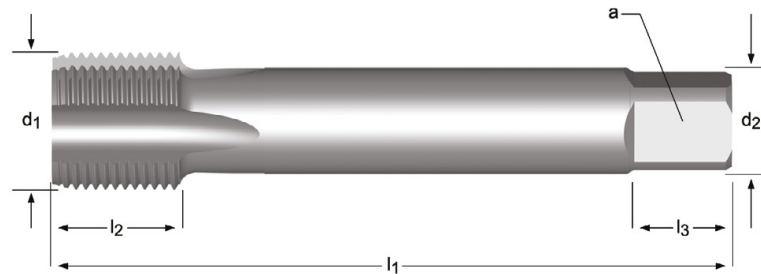

G(BSP)	TPI	d ₁ nom mm	l ₁ mm	l ₂ mm	d ₂ Ø mm	∠ a mm	l ₃ mm	z	↔	E282
1/8	28	9.73	90	20	7.0	5.5	8	3	8.8	E2821/8
1/4	19	13.16	100	21	11.0	9.0	12	4	11.8	E2821/4
3/8	19	16.66	100	21	12.0	9.0	12	4	15.25	E2823/8
1/2	14	20.96	125	24	16.0	12.0	15	4	19.0	E2821/2
3/4	14	26.44	140	28	20.0	16.0	19	4	24.5	E2823/4
1"	11	33.25	160	30	25.0	20.0	23	4	30.75	E2821
1.1/4	11	41.91	170	30	32.0	24.0	27	4	39.5	E2821.1/4 ¹⁾
1.1/2	11	47.80	190	32	36.0	29.0	32	6	45.0	E2821.1/2 ¹⁾

- E547**
- G(BSP) strojní závitník
 - G(BSP) Машинные метчики с прямой стружечной канавкой
 - G(BSP) Gwintownik maszynowy, prosty rowek wiórowy
 - G(BSP) Strojový závitník

E547 • 1.1 1.2 1.3 1.4 1.5 3.1 3.2 3.3 3.4 6.1 6.2 6.3 6.4 7.2 7.3 7.4 8.2 8.3

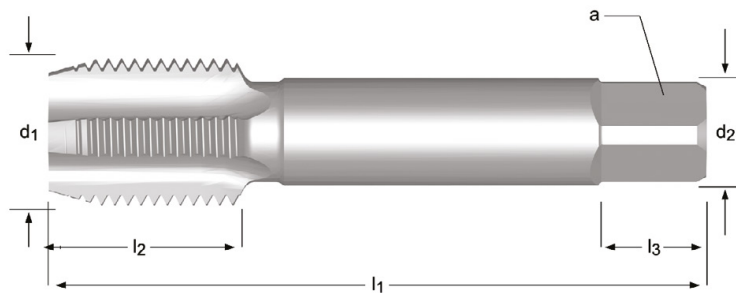

G(BSP)	TPI	d ₁ nom mm	l ₁ mm	l ₂ mm	d ₂ Ø mm	□ a mm	l ₃ mm	z		E547
1/8	28	9.728	59	15	8.0	8.0	9	4	8.8	E5471/8NO1
1/8	28	9.728	59	15	8.0	6.3	9	4	8.8	E5471/8NO2
1/8	28	9.728	59	15	8.0	6.3	9	4	8.8	E5471/8NO3
1/8	28	9.728	59	15	8.0	6.3	9	4	8.8	E5471/8NO7
1/4	19	13.157	67	19	10.0	8.0	11	4	11.8	E5471/4NO1
1/4	19	13.157	67	19	10.0	8.0	11	4	11.8	E5471/4NO2
1/4	19	13.157	67	19	10.0	8.0	11	4	11.8	E5471/4NO3
1/4	19	13.157	67	19	10.0	8.0	11	4	11.8	E5471/4NO7
3/8	19	16.662	75	21	12.5	10.0	13	4	15.25	E5473/8NO1
3/8	19	16.662	75	21	12.5	10.0	13	4	15.25	E5473/8NO2
3/8	19	16.662	75	21	12.5	10.0	13	4	15.25	E5473/8NO3
3/8	19	16.662	75	21	12.5	10.0	13	4	15.25	E5473/8NO7
1/2	14	20.955	87	26	16.0	12.5	16	4	19	E5471/2NO1
1/2	14	20.955	87	26	16.0	12.5	16	4	19	E5471/2NO2
1/2	14	20.955	87	26	16.0	12.5	16	4	19	E5471/2NO3
1/2	14	20.955	87	26	16.0	12.5	16	4	19	E5471/2NO7
5/8	14	22.911	91	26	18.0	14.0	18	4	21	E5475/8NO1
5/8	14	22.911	91	26	18.0	14.0	18	4	21	E5475/8NO2
5/8	14	22.911	91	26	18.0	14.0	18	4	21	E5475/8NO3
5/8	14	22.911	91	26	18.0	14.0	18	4	21	E5475/8NO7
3/4	14	26.441	96	28	20.0	16.0	20	4	24.5	E5473/4NO1
3/4	14	26.441	96	28	20.0	16.0	20	4	24.5	E5473/4NO2
3/4	14	26.441	96	28	20.0	16.0	20	4	24.5	E5473/4NO3
3/4	14	26.441	96	28	20.0	16.0	20	4	24.5	E5473/4NO7
7/8	14	30.201	102	29	22.4	18.0	22	4	28.25	E5477/8NO1
7/8	14	30.201	102	29	22.4	18.0	22	4	28.25	E5477/8NO2
7/8	14	30.201	102	29	22.4	18.0	22	4	28.25	E5477/8NO3
1"	11	33.249	109	33	25.0	20.0	24	4	30.75	E5471NO1
1"	11	33.249	109	33	25.0	20.0	24	4	30.75	E5471NO2
1"	11	33.249	109	33	25.0	20.0	24	4	30.75	E5471NO3
1.1/4	11	41.910	119	36	31.5	25.0	28	6	39.5	E5471.1/4NO1
1.1/4	11	41.910	119	36	31.5	25.0	28	6	39.5	E5471.1/4NO2
1.1/4	11	41.910	119	36	31.5	25.0	28	6	39.5	E5471.1/4NO3
1.1/2	11	47.803	125	37	35.5	28.0	31	6	45	E5471.1/2NO1
1.1/2	11	47.803	125	37	35.5	28.0	31	6	45	E5471.1/2NO2
1.1/2	11	47.803	125	37	35.5	28.0	31	6	45	E5471.1/2NO3
2"	11	59.614	140	41	40.0	31.5	34	6	57	E5472NO1
2"	11	59.614	140	41	40.0	31.5	34	6	57	E5472NO2
2"	11	59.614	140	41	40.0	31.5	34	6	57	E5472NO3

EP40 EP41

- G(BSP) strojní závitník, přímá drážka, lamač
- G(BSP) Машинные метчики с подточкой по заборному конусу
- G(BSP) Gwintownik maszynowy prosty
- G(BSP) Strojový závitník, priama drážka s lamačom triesok

Do vyprodání skladu dodáváno v HSS-E

HSS-E до складирования новой продукции

Do wyczerpania obecnych zapasów magazynowych dostepny ze stali HSS-E

Do vypredania skladu dodávané v HSS-E

EP40	▪	1.1	1.2	1.3	1.4	1.5	6.1	6.3	7.1	7.2	7.3	7.4
	•	1.6	3.1	3.2	3.3	3.4	4.1	4.2	5.1	5.2	6.2	8.1
EP41	▪	1.1	1.2	1.3	1.4	1.5						
	•	1.6	2.1	2.2	2.3	3.1	3.2	3.3	3.4			

EP40	G	DIN 5156	Normal		2.5XD	HSS-E PM	B 3.5-5				
EP41	G	DIN 5156	Normal		2.5XD	HSS-E PM	B 3.5-5			ST	

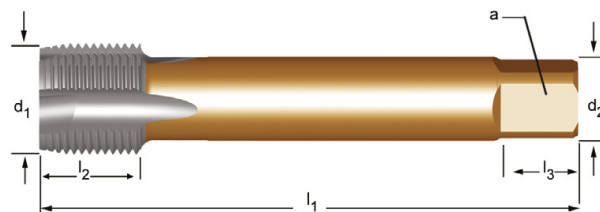

G(BSP)	TPI	d ₁ nom mm	l ₁ mm	l ₂ mm	d ₂ ∅ mm	∠ a mm	l ₃ mm	z		EP40	EP41
1/8	28	9.728	90	18	7.0	5.5	8	3	8.8	EP401/8	EP411/8
1/4	19	13.157	100	21	11.0	9.0	12	3	11.8	EP401/4	EP411/4
3/8	19	16.662	100	21	12.0	9.0	12	4	15.25	EP403/8	EP413/8
1/2	14	20.955	125	24	16.0	12.0	15	4	19.0	EP401/2	EP411/2
5/8	14	22.911	125	24	18.0	14.5	17	4	21	EP405/8	EP415/8
3/4	14	26.441	140	28	20.0	16.0	19	4	24.5	EP403/4	EP413/4
7/8	14	30.201	150	28	22.0	18.0	21	4	28.25	EP407/8	EP417/8
1"	11	33.249	160	30	25.0	20.0	23	4	30.75	EP401	EP411

E041

- G(BSP) strojní závitník, přímá drážka, lamač
- G(BSP) Машинные метчики с подточкой по заборному конусу
- G(BSP) Gwintownik maszynowy prosty
- G(BSP) Strojový závitník, priama drážka s lamačom triesok

Do vyprodání skladu dodáváno v HSS-E
HSS-E до складирования новой продукции
Do wyczerpania obecnych zapasów magazynowych dostepny ze stali HSS-E
Do vypredania skladu dodávané v HSS-E

E041	▪	1.1	1.2	1.3	1.4	1.5			
	•	1.6	2.1	2.2	2.3	3.1	3.2	3.3	3.4

E041

G



Normal



2.5XD

HSS-E
PM

B
3.5-5

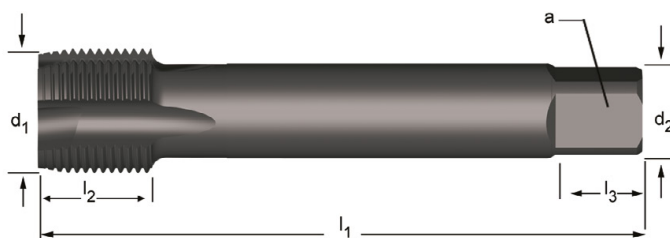

E041



1/8 - 3/4

G(BSP)	TPI	d ₁ nom mm	l ₁ mm	l ₂ mm	d ₂ Ø mm	□ a mm	l ₃ mm	z		E041
1/8	28	9.728	90	15	8.0	6.3	9	3	8.80	E0411/8
1/4	19	13.157	100	19	10.0	8.0	11	3	11.80	E0411/4
3/8	19	16.662	100	21	12.5	10.0	13	3	15.25	E0413/8
1/2	14	20.955	125	26	16.0	12.5	16	4	19.00	E0411/2
3/4	14	26.441	140	28	20.0	16.0	20	4	24.50	E0413/4

EX40 EX41

- G(BSP) strojní závitník, šroubovice 45°
- G(BSP) Машинные метчики со спиральной стружечной канавкой 45°
- G(BSP) Gwintownik maszynowy skrętny 45°
- G(BSP) Strojový závitník, skrutkovica 45°

Do vyprodání skladu dodáváno v HSS-E

HSS-E до складирования новой продукции

Do wyczerpania obecnych zapasów magazynowych dostepny ze stali HSS-E

Do vypredania skladu dodávané v HSS-E

EX40	▪	1.1	1.2	1.3	1.4	1.5	7.1	7.2	7.3	7.4
	•	4.1	4.2	5.1	5.2	8.1				
EX41	▪	1.1	1.2	1.3	1.4	1.5	2.1	2.2		
	•	2.3								

EX40	G	DIN 5156	Normal		2.5XD	HSS-E PM	C 2-3	 λ45°			
EX41	G	DIN 5156	Normal		2.5XD	HSS-E PM	C 2-3	 λ45°		ST	

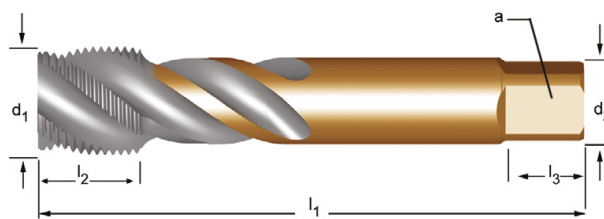

G(BSP)	TPI	d ₁ nom mm	l ₁ mm	l ₂ mm	d ₂ Ø mm	□ a mm	l ₃ mm	z		EX40	EX41
1/8	28	9.728	90	13	7.0	5.5	8	3	8.8	EX401/8	EX411/8
1/4	19	13.157	100	15	11.0	9.0	12	3	11.8	EX401/4	EX411/4
3/8	19	16.662	100	15	12.0	9.0	12	4	15.25	EX403/8	EX413/8
1/2	14	20.955	125	18	16.0	12.0	15	4	19.0	EX401/2	EX411/2
5/8	14	22.911	125	18	18.0	14.5	17	4	21	EX405/8	EX415/8
3/4	14	26.441	140	20	20.0	16.0	19	4	24.5	EX403/4	EX413/4
7/8	14	30.201	150	20	22.0	18.0	21	4	28.25	EX407/8	EX417/8
1"	11	33.249	160	22	25.0	20.0	23	4	30.75	EX401	EX411
1.1/8	11	37.897	170	22	28.0	22.0	25	4	35	EX401.1/8	EX411.1/8
1.1/4	11	41.910	170	22	32.0	24.0	27	4	39.5	EX401.1/4	¹⁾ EX411.1/4
1.1/2	11	47.803	190	23	36.0	29.0	32	4	45	EX401.1/2	¹⁾ EX411.1/2

- E382**
- G(BSP) strojní závitník, šroubovice 40°, modrý Shark
 - G(BSP) Машинные метчики со спиральной стружечной канавкой 40°, Blue Shark
 - G(BSP) Gwintownik maszynowy skrętny 40° niebieski Shark
 - G(BSP) Strojový závitník, skrutkovica 40°, modrý Shark

E382 ■ 2.1 2.2 2.3
 • 1.5

E382 **G** **DIN 5156** Normal **2XD** **HSS-E PM** **C 2-3** **λ40°** **ST**

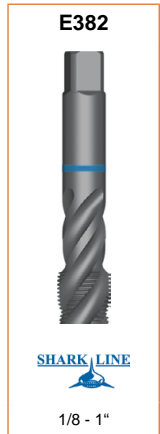
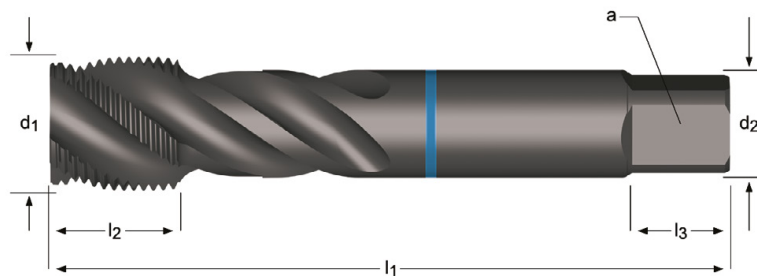

G(BSP)	TPI	d ₁ nom mm	l ₁ mm	l ₂ mm	d ₂ ∅ mm	∠ a mm	l ₃ mm	z		E382
1/8	28	9.73	90	12	7.0	5.5	8	3	8.8	E3821/8
1/4	19	13.16	100	15	11.0	9.0	12	4	11.8	E3821/4
3/8	19	16.66	100	15	12.0	9.0	12	4	15.25	E3823/8
1/2	14	20.96	125	24	16.0	12.0	15	4	19.0	E3821/2
3/4	14	26.44	140	20	20.0	16.0	19	4	24.5	E3823/4
1"	11	33.25	160	24	25.0	20.0	23	4	30.75	E3821

E043

- G(BSP) strojní závitník, šroubovice 45°
- G(BSP) Машинные метчики со спиральной стружечной канавкой 45°
- G(BSP) Gwintownik maszynowy skrętny 45°
- G(BSP) Strojový závitník, skrutkovica 45°

Do vyprodání skladu dodáváno v HSS-E
 HSS-E до складирования новой продукции
 Do wyczerpania obecnych zapasów magazynowych dostepny ze stali HSS-E
 Do vypredania skladu dodawane v HSS-E

E043	▪	1.1	1.2	1.3	1.4	1.5
	•	1.6	2.1	2.2	2.3	

E043 **G** **Normal** **HSS-E PM** **C** **2-3**

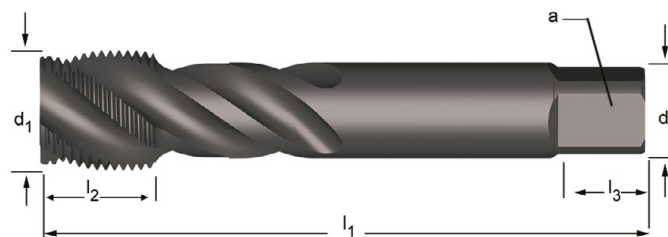

G(BSP)	TPI	d ₁ nom mm	l ₁ mm	l ₂ mm	d ₂ ∅ mm	∠ a mm	l ₃ mm	z		E043
1/8	28	9.728	90	15	8.0	6.3	9	3	8.80	E0431/8
1/4	19	13.157	100	19	10.0	8.0	11	3	11.80	E0431/4
3/8	19	16.662	100	21	12.5	10.0	13	4	15.25	E0433/8
1/2	14	20.955	125	26	16.0	12.5	16	4	19.00	E0431/2
3/4	14	26.441	140	28	20.0	16.0	20	4	24.50	E0433/4

- E620**
- EGM strojní závitník
 - EGM Машинные метчики с прямой стружечной канавкой
 - EGM Gwintownik maszynowy, prosty rowek wiórowy
 - EGM Strojový závitník

E620 • 1.1 1.2 1.3 1.4 1.5 3.1 3.2 3.3 3.4 6.1 6.2 6.3 6.4 7.2 7.3 7.4 8.2 8.3

E620 EGM DORMER ISO 6H 1.5XD HSS C 2-3

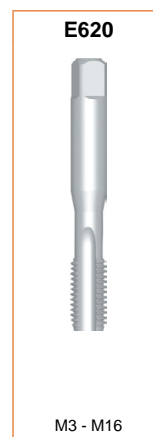
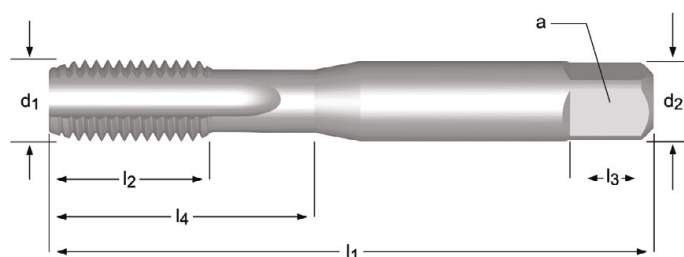

M	P mm	d ₁ nom mm	l ₁ mm	l ₂ mm	d ₂ Ø mm	∠ a mm	l ₃ mm	z	↔	l ₄ mm	E620
3	0.50	3.65	53	14	4.0	3.15	6	3	3.2	14	E620M3
4	0.70	4.91	58	11	5.0	4.00	7	3	4.2	20	E620M4
5	0.80	6.04	66	13	6.3	5.00	8	3	5.2	26	E620M5
6	1.00	7.30	72	16	8.0	6.30	9	3	6.3	29	E620M6
8	1.25	9.62	80	18	10.0	8.00	11	3	8.4	32	E620M8
10	1.50	11.95	89	22	9.0	7.10	10	3	10.5	-	E620M10
12	1.75	14.27	95	24	11.2	9.00	12	4	12.5	-	E620M12
14	2.00	16.60	112	29	14.0	11.20	14	4	14.5	-	E620M14
16	2.00	18.60	112	29	14.0	11.20	14	4	16.5	-	E620M16

- E621**
- EGM strojní závitník, šroubovice 40°
 - EGM Машинные метчики со спиральной стружечной канавкой 40°
 - EGM Gwintownik maszynowy skrętny 40°
 - EGM Strojový závitník, skrutkovica 40°

E621 • 1.2 1.3 1.4 1.5 2.1 2.2 2.3 5.2 7.1 7.2 7.3 7.4

E621 EGM DORMER ISO 6H 2XD HSS C 2-3 λ40°

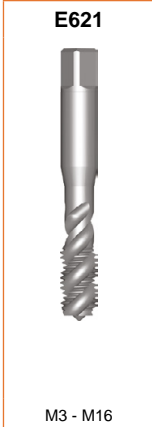
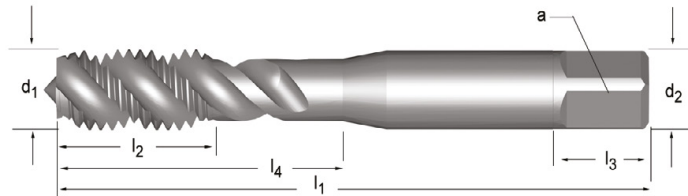



M	P mm	d ₁ nom mm	l ₁ mm	l ₂ mm	d ₂ Ø mm	∠ a mm	l ₃ mm	z	↔	l ₄ mm	E621
3	0.50	3.65	53	14	4.00	3.15	6	3	3.2	14	E621M3
4	0.70	4.91	58	11	5.00	4.00	7	3	4.2	20	E621M4
5	0.80	6.04	66	13	6.30	5.00	8	3	5.2	26	E621M5
6	1.00	7.3	72	16	8.00	6.30	9	3	6.3	31	E621M6
8	1.25	9.62	80	18	10.00	8.00	11	3	8.4	34	E621M8
10	1.50	11.95	89	22	9.00	7.10	10	3	10.5	-	E621M10
12	1.75	14.27	95	24	11.20	9.00	12	3	12.5	-	E621M12
14	2.00	16.6	112	29	14.00	11.20	14	3	14.5	-	E621M14
16	2.00	18.6	112	29	14.00	11.20	14	3	16.5	-	E621M16

- E550**
- Rc strojní závitník
 - Rc Машинные метчики с прямой стружечной канавкой
 - Rc Gwintownik maszynowy, prosty rowek wiórowy
 - Rc Strojový závitník

E550	▪	3.1	3.2	3.3	3.4	6.1												
	•	1.1	1.2	1.3	1.4	1.5	1.6	2.1	2.2	2.3	6.2	6.3	6.4	7.2	7.3	7.4	8.2	8.3

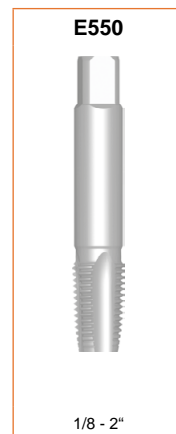
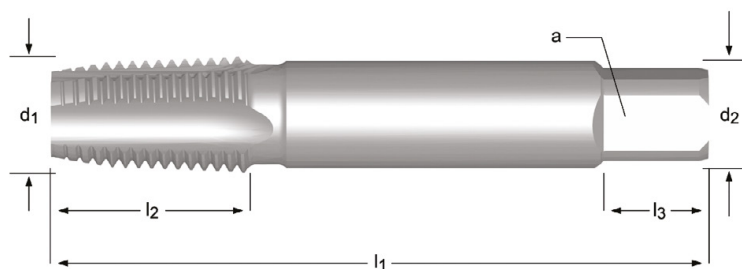
E550 **Rc** **ISO 2284** Normal  **1.5XD** **HSS** **C 2-3**    



Rc	TPI	d ₁ nom mm	l ₁ mm	l ₂ mm	d ₂ ∅ mm	a mm	l ₃ mm	z		E550
1/8	28	9.728	59	15	8.0	6.3	9	3	8.4	E5501/8
1/8	28	9.728	59	15	8.0	6.3	9	3	8.4	E5501/8NO7
1/4	19	13.157	67	19	10.0	8.0	11	3	11.2	E5501/4
1/4	19	13.157	67	19	10.0	8.0	11	3	11.2	E5501/4NO7
3/8	19	16.662	75	21	12.5	10.0	13	3	14.75	E5503/8
3/8	19	16.662	75	21	12.5	10.0	13	3	14.75	E5503/8NO7
1/2	14	20.955	87	26	16.0	12.5	16	5	18.25	E5501/2
1/2	14	20.955	87	26	16.0	12.5	16	5	18.25	E5501/2NO7
3/4	14	26.441	96	28	20.0	16.0	20	5	23.75	E5503/4
3/4	14	26.441	96	28	20.0	16.0	20	5	23.75	E5503/4NO7
1"	11	33.249	109	33	25.0	20.0	24	5	30	E5501
1.1/4	11	41.910	119	36	31.5	25.0	28	5	38.5	E5501.1/4
1.1/2	11	47.803	125	37	35.5	28.0	31	7	44.5	E5501.1/2
2"	11	59.614	140	41	40.0	31.5	34	7	56	E5502

NO1 - NO9
219

E714

- NPT strojní závitník
- NPT Машинные метчики с прямой стружечной канавкой
- NPT Gwintowniki maszynowe, prosty rowek wiórowy
- NPT Strojový závitník

Do vyprodání skladu dodáváno v HSS-E
 HSS-E до складирования новой продукции
 Do wyczerpania obecnych zapasów magazynowych dostepny ze stali HSS-E
 Do vypredania skladu dodávané v HSS-E

E714 ■ 1.3 1.4
 • 1.1 1.2 1.5 3.1 3.2 3.3 3.4 6.2 7.3 7.4 8.1

E714 NPT Normal HSS-E PM

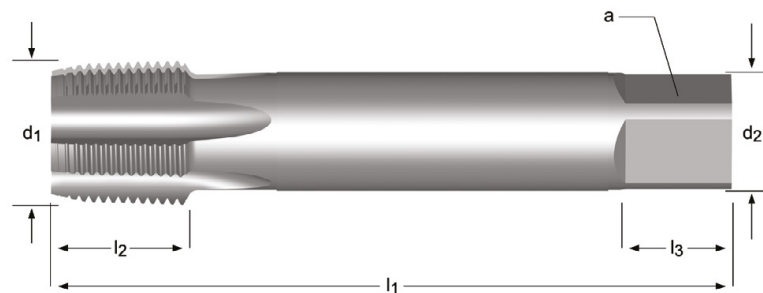

NPT	TPI	d ₁ nom mm	l ₁ mm	l ₂ mm	d ₂ ∅ mm	∠ a mm	l ₃ mm	z		E714
1/8	27	10.23	90	14	11.0	9.0	12	3	8.5	E7141/8
1/4	18	13.60	100	20	14.0	11.0	14	3	11	E7141/4
3/8	18	17.04	110	20	16.0	12.0	15	4	14.5	E7143/8
1/2	14	21.20	125	26	18.0	14.5	17	4	18	E7141/2
3/4	14	26.54	140	26	22.0	18.0	21	5	23	E7143/4
1"	11.5	33.20	150	31	28.0	22.0	25	5	29	E7141

- E710** • NPT strojní závitník
 • NPT Машинные метчики с прямой стружечной канавкой
- E721** • NPT Gwintowniki maszynowe, prosty rowek wiórowy
 • NPT Strojový závitník

E710	•	1.1	1.2	1.3	1.4	1.5	3.1	3.2	3.3	3.4	6.2	7.3	7.4	8.1
E721	▪	1.3	1.4	3.1	3.2	3.3	3.4							
	•	1.1	1.2	1.5	6.2	7.3	7.4	8.1						

E710	NPT	ANSI B94.9	Normal		1.5XD	HSS	C 2-3				
E721	NPT	ANSI B94.9	Normal		1.5XD	HSS	C 2-3			TiN	

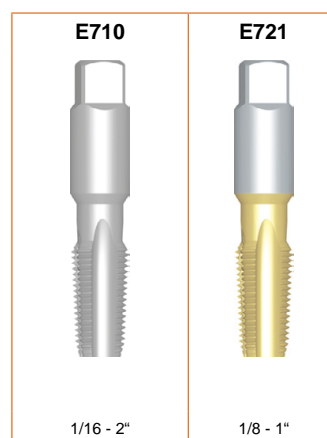
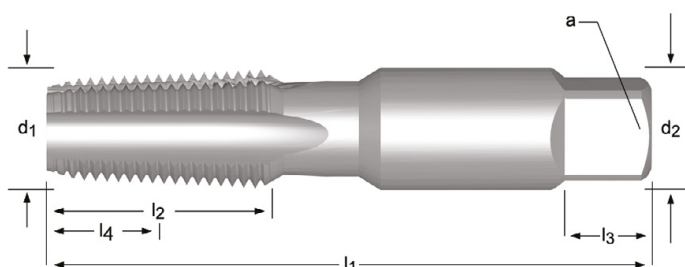

NPT	TPI	d ₁ nom mm	l ₁ mm	l ₂ mm	l ₄ mm	d ₂ Ø mm	□ a mm	l ₃ mm	z		E710	E721
1/16	27	7.94	65	17	11.7	8.1	6.0	8	4	6.3	E7101/16NO3	
1/8	27	10.29	70	19	11.9	11.1	8.3	10	4	8.5	E7101/8	E7211/8
1/8	27	10.29	70	19	11.9	11.1	8.3	10	4	8.5	E7101/8NO7	
1/4	18	13.72	75	27	17.6	14.3	10.7	11	4	11.0	E7101/4	E7211/4
1/4	18	13.72	75	27	17.6	14.3	10.7	11	4	11.0	E7101/4NO7	
3/8	18	17.15	80	27	19.5	17.8	13.5	13	4	14.5	E7103/8	E7213/8
3/8	18	17.15	80	27	19.5	17.8	13.5	13	4	14.5	E7103/8NO7	
1/2	14	21.34	100	35	22.7	17.5	13.1	16	4	18.0	E7101/2	E7211/2
1/2	14	21.34	100	35	22.7	17.5	13.1	16	4	18.0	E7101/2NO7	
3/4	14	26.67	105	35	24.4	23.0	17.2	17	5	23.0	E7103/4	E7213/4
3/4	14	26.67	105	35	24.4	23.0	17.2	17	5	23.0	E7103/4NO7	
1"	11.5	33.40	115	43	29.4	28.6	21.4	21	5	29.0	E7101	E7211
1.1/4	11.5	42.16	125	43	27.7	33.3	25.0	24	5	38.0	E7101.1/4	
1.1/2	11.5	48.26	135	43	28.9	38.1	28.6	25	7	44.0	E7101.1/2	
2"	11.5	60.33	145	43	26.6	47.6	35.7	29	7	56.0	E7102	

NO1 - NO9



E711

- NPT strojní závitník, přerušovány
- NPT Машинные метчики с шахматным расположением зубьев
- NPT Gwintownik maszynowy z przerywanym nakrojem, prosty rowek wiórowy
- NPT Strojový závitník, prerušovaný

E711 ■ 1.3 1.4
 • 1.1 1.2 1.5 3.1 3.2 3.3 3.4 6.2 7.3 7.4 8.1

E711 NPT ANSI B94.9 Normal 1.5XD HSS C 2-3

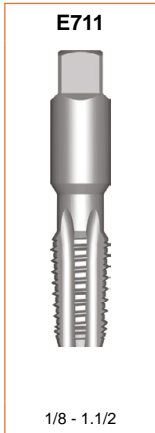
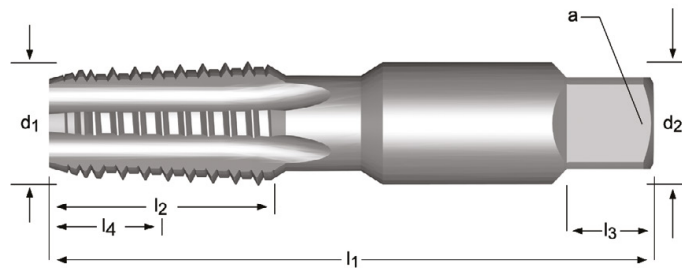

NPT	TPI	d ₁ nom mm	l ₁ mm	l ₂ mm	l ₄ mm	d ₂ ∅ mm	□ a mm	l ₃ mm	z		E711
1/8	27	10.29	70	19	11.9	11.1	8.3	10	5	8.5	E7111/8
1/4	18	13.72	75	27	17.6	14.3	10.7	11	5	11.0	E7111/4
3/8	18	17.15	80	27	19.5	17.8	13.5	13	5	14.5	E7113/8
1/2	14	21.33	100	35	22.7	17.5	13.1	16	5	18.0	E7111/2
3/4	14	26.67	105	35	24.4	23.0	17.2	17	5	23.0	E7113/4
1"	11.5	33.40	115	43	29.4	28.6	21.4	21	5	29.0	E7111
1.1/2	11.5	48.26	135	43	28.9	38.1	28.6	25	7	44.0	E7111.1/2

E653

- NPT Závitník kombi
- NPT Комбинированные метчики со спиральной стружечной канавкой 27°
- NPT Wiertło/gwintownik skrętny 27°
- NPT Závitník kombinovaný, špirálový 27°

E653 • 1.1 1.2 1.3 1.4 3.2 6.2 6.3 7.1 7.2 8.1

E653 NPT ANSI Normal 1.5XD HSS λ27°

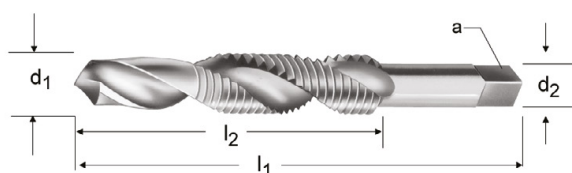

E653



1/8 - 1"

NPT	TPI	d_1 nom Inch	l_1 Inch	l_2 Inch	d_2 Ø Inch	\square a Inch	z	E653
1/8	27	0.3346	2.7/8	3/4	0.4370	0.3280	2	E6531/8
1/4	18	0.4331	3.5/16	1.1/16	0.5620	0.4210	2	E6531/4
3/8	18	0.5709	3.1/2	1.1/16	0.7000	0.5310	2	E6533/8
1/2	14	0.7087	4.3/8	1.3/8	0.6870	0.5150	2	E6531/2
3/4	14	0.9055	4.9/16	1.3/8	0.9060	0.6790	2	E6533/4
1"	11.5	1.1417	5.3/8	1.3/4	1.1250	0.8430	2	E6531

- E712**
- NPTF Závětník strojní
 - NPTF Машинные метчики с прямой стружечной канавкой
 - NPTF Gwintownik maszynowy, prosty rowek wiórowy
 - NPTF Strojový závětník

E712 ■ 1.3 1.4
 • 1.1 1.2 1.5 3.1 3.2 3.3 3.4 6.2 7.3 7.4 8.1

E712 NPTF ANSI B94.9 Normal 1.5XD HSS C 2-3

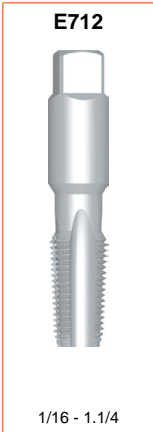
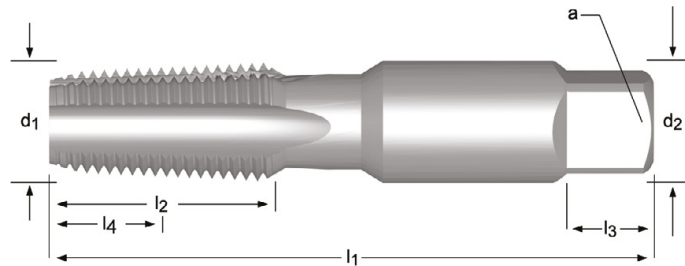

NPTF	TPI	d ₁ nom mm	l ₁ mm	l ₂ mm	l ₄ mm	d ₂ ∅ mm	∠ a mm	l ₃ mm	z		E712
1/16	27	7.94	65	17	11.7	8.1	6.0	8	4	6.20	E7121/16
1/8	27	10.29	70	19	11.9	11.1	8.3	10	4	8.40	E7121/8
1/4	18	13.72	75	27	17.6	14.3	10.7	11	4	10.90	E7121/4
3/8	18	17.15	80	27	19.5	17.8	13.5	13	4	14.25	E7123/8
1/2	14	21.34	100	35	22.7	17.5	13.1	16	4	17.75	E7121/2
3/4	14	26.67	105	35	24.4	23.0	17.2	17	5	23.00	E7123/4
1"	11.5	33.40	115	43	29.4	28.6	21.4	21	5	29.00	E7121
1.1/4	11.5	42.16	125	43	27.7	33.4	24.9	23	5	37.75	E7121.1/4

- E709** • NPSF strojní závitník
• NPSF Машинные метчики с прямой стружечной канавкой
- E720** • NPSF Gwintowniki maszynowe, prosty rowek wiórowy
• NPSF Strojový závitník

E709	▪	1.3	1.4									
	•	1.1	1.2	1.5	3.1	3.2	3.3	3.4	6.2	7.3	7.4	8.1
E720	▪	1.3	1.4	3.1	3.2	3.3	3.4					
	•	1.1	1.2	1.5	6.2	7.3	7.4	8.1				

E709	NPSF	ANSI B94.9	Normal		1.5XD	HSS	C 2-3				
E720	NPSF	ANSI B94.9	Normal		1.5XD	HSS	C 2-3				TiN

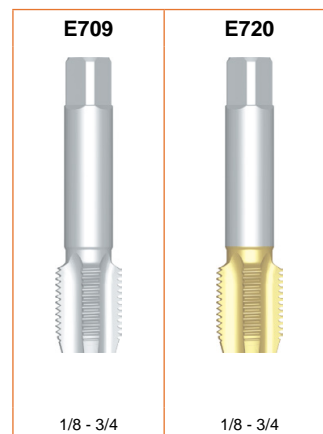
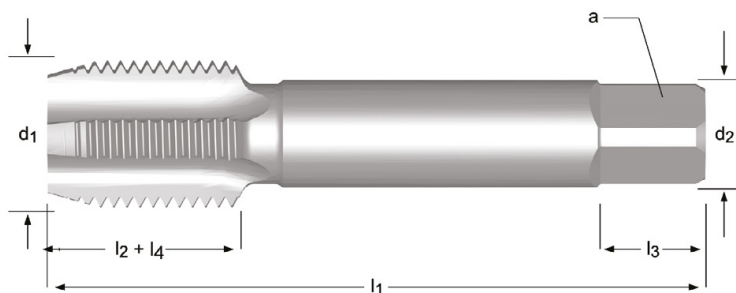

NPSF	TPI	d ₁ nom mm	l ₁ mm	l ₂ mm	l ₄ mm	d ₂ ∅ mm	∠ a mm	l ₃ mm	z		E709	E720
1/8	27	10.29	70	19	19	11.1	8.3	10	4	8.70	E7091/8	E7201/8NO3
1/4	18	13.72	75	27	27	14.3	10.7	11	4	11.30	E7091/4	E7201/4NO3
3/8	18	17.15	80	27	27	17.8	13.5	13	4	14.75	E7093/8	E7203/8NO3
1/2	14	21.34	100	35	-	17.5	13.1	16	4	18.25	E7091/2	E7201/2NO3
3/4	14	26.67	105	35	-	23.0	17.2	17	5	23.50	E7093/4	E7203/4NO3

N01 - N09

219

- E708**
- NPSM strojní závitník
 - NPSM Машинные метчики с прямой стружечной канавкой
 - NPSM Gwintownik maszynowy, prosty rowek wiórowy
 - NPSM Strojový závitník

E708 ■ 1.3 1.4
 • 1.1 1.2 1.5 3.1 3.2 3.3 3.4 6.2 7.3 7.4 8.1

E708 NPSM ANSI B94.9 Normal 1.5XD HSS C 2-3

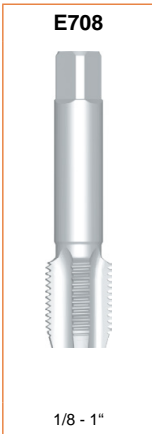
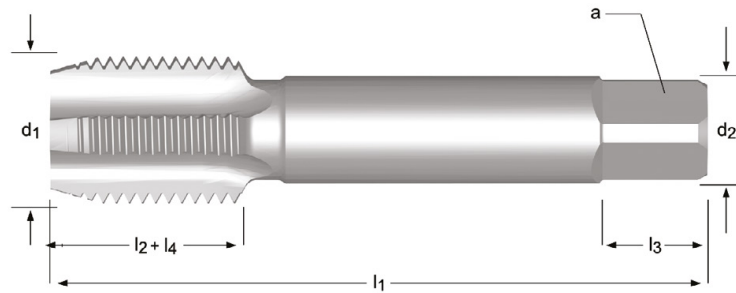

NPSM	TPI	d ₁ nom mm	l ₁ mm	l ₂ mm	l ₄ mm	d ₂ ∅ mm	□ a mm	l ₃ mm	z		E708
1/8	27	10.29	70	19	19	11.1	8.3	10	4	9.1	E7081/8
1/4	18	13.72	75	27	27	14.3	10.7	11	4	12.0	E7081/4
3/8	18	17.15	80	27	27	17.8	13.5	13	4	15.5	E7083/8
1/2	14	21.33	100	35	-	17.5	13.1	16	4	19.0	E7081/2
3/4	14	26.67	105	35	-	23.0	17.2	17	5	24.5	E7083/4
1"	11.5	33.40	115	43	-	28.6	21.4	21	5	30.5	E7081

- E243**
- PG strojní závitník
 - PG Машинные метчики с прямой стружечной канавкой
 - PG Gwintownik maszynowy, prosty rowek wiórowy
 - PG Strojový závitník

E243 • 1.1 1.2 1.3 1.4 1.5 3.1 3.2 3.3 6.2 6.3 7.2 7.3 8.2

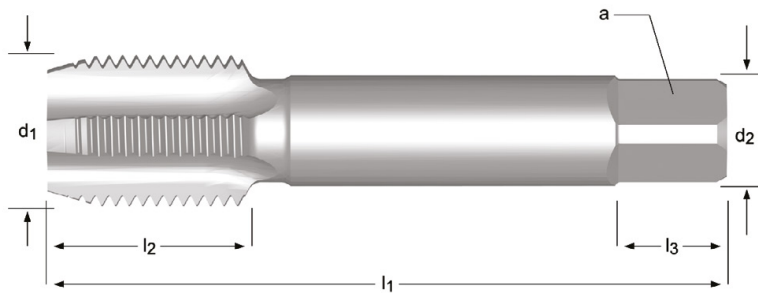
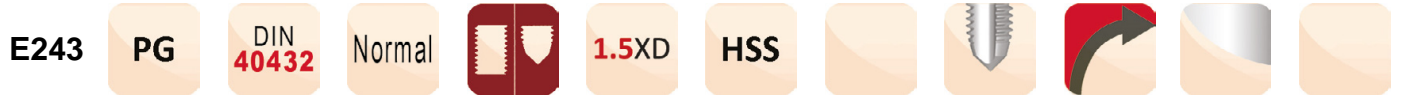

E243



No.7 - No.36

PG	TPI	d ₁ nom mm	l ₁ mm	l ₂ mm	d ₂ ∅ mm	∟ a mm	l ₃ mm	z	↔	E243
7	20	12.5	70	22	9.0	7.0	10	4	11.4	E243PG7NO2
7	20	12.5	70	22	9.0	7.0	10	4	11.4	E243PG7NO3
9	18	15.2	70	22	12.0	9.0	12	4	13.9	E243PG9NO2
9	18	15.2	70	22	12.0	9.0	12	4	13.9	E243PG9NO3
11	18	18.6	80	22	14.0	11.0	14	4	17.25	E243PG11NO2
11	18	18.6	80	22	14.0	11.0	14	4	17.25	E243PG11NO3
13.5	18	20.4	80	22	16.0	12.0	15	4	19	E243PG13.5NO2
13.5	18	20.4	80	22	16.0	12.0	15	4	19	E243PG13.5NO3
16	18	22.5	80	22	18.0	14.5	17	4	21.25	E243PG16NO2
16	18	22.5	80	22	18.0	14.5	17	4	21.25	E243PG16NO3
21	16	28.3	90	22	22.0	18.0	21	4	27	E243PG21NO2
21	16	28.3	90	22	22.0	18.0	21	4	27	E243PG21NO3
29	16	37.0	100	25	28.0	22.0	25	6	35.5	E243PG29NO2
29	16	37.0	100	25	28.0	22.0	25	6	35.5	E243PG29NO3
36	16	47.0	140	32	36.0	29.0	32	6	45.5	E243PG36NO2
36	16	47.0	140	32	36.0	29.0	32	6	45.5	E243PG36NO3

N01 - N09



219

L119

- Metrické závitníky, kovová krabice
- Набор метрических метчиков
- Zestaw Metrycznych Gwintowników maszynowych
- Metrické závitníky, kovová krabica

- A=typy v sadě, B=počet v sadě, M=rozměry závitníky v sadě
 A=тип метчика в наборе, B=кол-во метчиков, M=метчики в наборе
 A=Typy w komplecie. B=Ilość w komplecie. M=Gwintowniki występujące w komplecie
 A=typy v sade, B=počet v sade, M=rozmery závitníkov v sade



Set	A	B	M	
Nr.17	E100	21	E100M3NO8, E100M4NO8, E100M5NO8, E100M6NO8, E100M8NO8, E100M10NO8, E100M12NO8	L119 L11917

L126

- Závětník kombi sada
- Комбинированный набор метчиков
- Zestaw wiertł/gwintownik
- Závětník kombinovaná sada

A=typy v sadě, B=počet v sadě, M=rozměry závětníky v sadě

A=тип метчика в наборе, B=кол-во метчиков, M=метчики в наборе

A=Typy w komplecie. B=Ilość w komplecie. M=Wiertł/gwintowniki występujące w komplecie

A=typy v sade, B=počet v sade, M=rozmery závětníkov v sade



Set	A	B	M	L126
650	E650	6	E650M4, E650M5, E650M6, E650M8, E650M10, E650M12	L126650

L113

- ISO sada vrták-závitník
- ISO Набор сверл и метчиков
- ISO Zestaw gwintowników i wiertel
- ISO sada vrták závitník

A=typy v sadě, B=počet v sadě, M=rozměry závitníky v sadě, D= rozměry vrtak v sadě
 A=тип метчика и сверла в наборе, B=кол-во метчиков, M=метчики в наборе, D=сверла в наборе
 A=Typy w komplecie. B=Ilość w komplecie. M=Gwintowniki występujące w komplecie D=Średnice wiertel występujące w komplecie
 A=typy v sade, B=počet v sade, M=rozmary závitníkov v sade, D= rozmary vrtákov v sade







Set	A	B	M	D	L113
Nr.201	E000 + A002	14	E000M3, E000M4, E000M5, E000M6, E000M8, E000M10, E000M12	A0022.5, A0023.3, A0024.2, A0025.0, A0026.8, A0028.5, A00210.2	L113201
Nr.202	E001 + A002	14	E001M3, E001M4, E001M5, E001M6, E001M8, E001M10, E001M12	A0022.5, A0023.3, A0024.2, A0025.0, A0026.8, A0028.5, A00210.2	L113202
Nr.203	E002 + A002	14	E002M3, E002M4, E002M5, E002M6, E002M8, E002M10, E002M12	A0022.5, A0023.3, A0024.2, A0025.0, A0026.8, A0028.5, A00210.2	L113203
Nr.204	E003 + A002	14	E003M3, E003M4, E003M5, E003M6, E003M8, E003M10, E003M12	A0022.5, A0023.3, A0024.2, A0025.0, A0026.8, A0028.5, A00210.2	L113204

L114

- DIN sada vrták-závítník
- DIN Набор сверл и метчиков
- DIN Zestaw gwintowników i wiertel
- DIN sada vrták závitník

A=typy v sadě, B=počet v sadě, M=rozměry závitníky v sadě, D= rozměry vrtak v sadě
 A=тип метчика и сверла в наборе, B=кол-во метчиков, M=метчики в наборе, D=сверла в наборе
 A=Typy w komplecie. B=Ilość w komplecie. M=Gwintowniki występujące w komplecie
 D=Średnice wiertel występujące w komplecie
 A=typy v sade, B=počet v sade, M=rozmery závitníkov v sade, D= rozmery vrtákov v sade



Set	A	B	M	D	L114
Nr.301	EP006H + A002	14	EP00M3, EP00M4, EP00M5, EP00M6, EP00M8, EP00M10, EP00M12	A0022.5, A0023.3, A0024.2, A0025.0, A0026.8, A0028.5, A00210.2	L114301
Nr.302	EX006H + A002	14	EX00M3, EX00M4, EX00M5, EX00M6, EX00M8, EX00M10, EX00M12	A0022.5, A0023.3, A0024.2, A0025.0, A0026.8, A0028.5, A00210.2	L114302
Nr.303	E297 + A002 	14	E297M3, E297M4, E297M5, E297M6, E297M8, E297M10, E297M12	A0022.5, A0023.3, A0024.2, A0025.0, A0026.8, A0028.5, A00210.2	L114303
Nr.304	E298 + A002 	14	E298M3, E298M4, E298M5, E298M6, E298M8, E298M10, E298M12	A0022.5, A0023.3, A0024.2, A0025.0, A0026.8, A0028.5, A00210.2	L114304
Nr.305	E238 + A108 	14	E238M3, E238M4, E238M5, E238M6, E238M8, E238M10, E238M12	A1082.5, A1083.3, A1084.2, A1085.0, A1086.8, A1088.5, A10810.2	L114305
Nr.306	E240 + A108 	14	E240M3, E240M4, E240M5, E240M6, E240M8, E240M10, E240M12	A1082.5, A1083.3, A1084.2, A1085.0, A1086.8, A1088.5, A10810.2	L114306

L115

- Sada vrták-závitník dle normy
- Набор сверл и метчиков
- Zestaw gwintowników i wiertel DIN
- Sada vrták-závitník podľa normy

A=typy v sadě, B=počet v sadě, M=rozměry závitníky v sadě, D= rozměry vrtak v sadě
 A=тип метчика и сверла в наборе, B=кол-во метчиков, M=метчики в наборе, D=сверла в наборе
 A=Typy w komplecie. B=Ilość w komplecie. M=Gwintowniki występujące w komplecie
 D=Średnice wiertel występujące w komplecie
 A=typy v sade, B=počet v sade, M=rozmary závitníkov v sade, D= rozmery vrtákov v sade

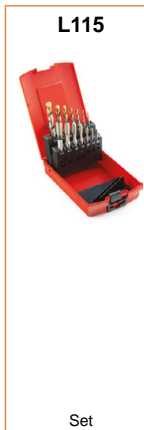

Set	A	B	M	D	L115
Nr.100	E500 + A022	21	E500M3NO2, E500M3NO3, E500M4NO2, E500M4NO3, E500M5NO2, E500M5NO3, E500M6NO2, E500M6NO3, E500M8NO2, E500M8NO3, E500M10NO2, E500M10NO3, E500M12NO2, E500M12NO3	A0222.5, A0223.3, A0224.2, A0225.0, A0226.8, A0228.5, A02210.2	L115100
Nr.101	E500 + A002	14	E500M3NO3, E500M4NO3, E500M5NO3, E500M6NO3, E500M8NO3, E500M10NO3, E500M12NO3	A0022.5, A0023.3, A0024.2, A0025.0, A0026.8, A0028.5, A00210.2	L115101

L000

- Sada vrtáků pro ruční závitník (2 kusy) A=typy v sadě, B=počet v sadě, M=rozměry závitníky v sadě, D= rozměry vrtak v sadě
- Набор ручных сверл и метчиков под резьбу (2 шт.) A=тип метчика и сверла в наборе, B=кол-во, M=метчик в наборе, D=сверло в наборе
- Zestaw gwintownik ręczny-wiertło (2 sztuki) A=Typy w komplecie. B=Ilość w komplecie. M=Gwintowniki występujące w komplecie D=Średnice wiertel występujące w komplecie
- Súprava manuálnych závitníkov (2 ks) A=typy v sade, B=počet v sade, M=rozmery závitníkov v sade, D= rozmery vrtákov v sade



Nr.	A	B	M	D	L000
Nr.1	E500 + A002	2	E500M3NO2	A0022.5	L000E500M3NO2XA002
Nr.2	E500 + A002	2	E500M4NO2	A0023.3	L000E500M4NO2XA002
Nr.3	E500 + A002	2	E500M5NO2	A0024.2	L000E500M5NO2XA002
Nr.4	E500 + A002	2	E500M6NO2	A0025.0	L000E500M6NO2XA002
Nr.5	E500 + A002	2	E500M8NO2	A0026.8	L000E500M8NO2XA002
Nr.6	E500 + A002	2	E500M10NO2	A0028.5	L000E500M10NO2XA002
Nr.7	E500 + A002	2	E500M12NO2	A00210.2	L000E500M12NO2XA002
Nr.8	E500 + A002	2	E500M3NO3	A0022.5	L000E500M3NO3XA002
Nr.9	E500 + A002	2	E500M4NO3	A0023.3	L000E500M4NO3XA002
Nr.10	E500 + A002	2	E500M5NO3	A0024.2	L000E500M5NO3XA002
Nr.11	E500 + A002	2	E500M6NO3	A0025.0	L000E500M6NO3XA002
Nr.12	E500 + A002	2	E500M8NO3	A0026.8	L000E500M8NO3XA002
Nr.13	E500 + A002	2	E500M10NO3	A0028.5	L000E500M10NO3XA002
Nr.14	E500 + A002	2	E500M12NO3	A00210.2	L000E500M12NO3XA002

L001

- Sada vrtáků pro závitník DIN (2 kusy)
- Набор сверл и метчиков под резьбу согласно DIN (2 шт.)
- Zestaw gwintownik DIN-wiertło (2 sztuki)
- Súprava závitníkov DIN (2 ks)

A=typy v sadě, B=počet v sadě, M=rozměry závitníky v sadě, D= rozměry vrtak v sadě
 A=тип метчика и сверла в наборе, B=кол-во, M=метчик в наборе, D=сверло в наборе
 A=Typy w kompletce. B=Ilość w kompletce. M=Gwintowniki występujące w kompletce
 D=Średnice wiertel występujące w kompletce
 A=typy v sade, B=počet v sade, M=rozmery závitníkov v sade, D= rozmery vrtákov v sade



Nr.	A	B	M	D	L001
Nr.1	EP006H + A002	2	EP00M3	A0022.5	L001EP00M3XA002
Nr.2	EP006H + A002	2	EP00M4	A0023.3	L001EP00M4XA002
Nr.3	EP006H + A002	2	EP00M5	A0024.2	L001EP00M5XA002
Nr.4	EP006H + A002	2	EP00M6	A0025.0	L001EP00M6XA002
Nr.5	EP006H + A002	2	EP00M8	A0026.8	L001EP00M8XA002
Nr.6	EP006H + A002	2	EP00M10	A0028.5	L001EP00M10XA002
Nr.7	EP006H + A002	2	EP00M12	A00210.2	L001EP00M12XA002
Nr.8	EX006H + A002	2	EX00M3	A0022.5	L001EX00M3XA002
Nr.9	EX006H + A002	2	EX00M4	A0023.3	L001EX00M4XA002
Nr.10	EX006H + A002	2	EX00M5	A0024.2	L001EX00M5XA002
Nr.11	EX006H + A002	2	EX00M6	A0025.0	L001EX00M6XA002
Nr.12	EX006H + A002	2	EX00M8	A0026.8	L001EX00M8XA002
Nr.13	EX006H + A002	2	EX00M10	A0028.5	L001EX00M10XA002
Nr.14	EX006H + A002	2	EX00M12	A00210.2	L001EX00M12XA002

L002

- Sada vrtáků pro závitník ISO (2 kusy)
- Набор сверл и метчиков под резьбу согласно ISO (2 шт.)
- Zestaw gwintownik ISO-wiertło (2 sztuki)
- Súprava závitníkov ISO (2 ks)

A=typy v sadě, B=počet v sadě, M=rozměry závitníky v sadě, D= rozměry vrtak v sadě

A=тип метчика и сверла в наборе, B=кол-во, M=метчик в наборе, D=сверло в наборе

A=Typy w komplecie. B=Ilość w komplecie. M=Gwintowniki występujące w komplecie
D=Średnice wiertel występujące w komplecie

A=typy v sade, B=počet v sade, M=rozmery závitníkov v sade, D= rozmery vrtakov v sade



Nr.	A	B	M	D	L002
Nr.1	E000 + A002	2	E000M3	A0022.5	L002E000M3XA002
Nr.2	E000 + A002	2	E000M4	A0023.3	L002E000M4XA002
Nr.3	E000 + A002	2	E000M5	A0024.2	L002E000M5XA002
Nr.4	E000 + A002	2	E000M6	A0025.0	L002E000M6XA002
Nr.5	E000 + A002	2	E000M8	A0026.8	L002E000M8XA002
Nr.6	E000 + A002	2	E000M10	A0028.5	L002E000M10XA002
Nr.7	E000 + A002	2	E000M12	A00210.2	L002E000M12XA002
Nr.8	E002 + A002	2	E002M3	A0022.5	L002E002M3XA002
Nr.9	E002 + A002	2	E002M4	A0023.3	L002E002M4XA002
Nr.10	E002 + A002	2	E002M5	A0024.2	L002E002M5XA002
Nr.11	E002 + A002	2	E002M6	A0025.0	L002E002M6XA002
Nr.12	E002 + A002	2	E002M8	A0026.8	L002E002M8XA002
Nr.13	E002 + A002	2	E002M10	A0028.5	L002E002M10XA002
Nr.14	E002 + A002	2	E002M12	A00210.2	L002E002M12XA002

L120

- Závítovací sada, kovová krabice
- Набор инструментов для нарезания резьбы
- Zestaw do gwintowania ręcznego - metalowa kasetka
- Závítovacia sada, kovová krabica

A=typy v sadě, B= No. in Set, B=počet v sadě, M=rozměry závitníky v sadě, F= rozměry očka v sadě, L112 - v sadě, L110 - v sadě

A=тип инструмента в наборе, B=кол-во в наборе, M=метчики в наборе, F=плашки в наборе, L112=воротки для метчиков в наборе, L110=воротки для плашек в наборе
A=Typy w komplecie. B=Ilość w komplecie. M=Gwintowniki występujące w komplecie. F= Narzynki występujące w komplecie.. L112= Uchwyty do gwintowników występujące w komplecie. L110= Uchwyty do narzynek występujące w komplecie.

A=typy v sade, B=počet v sadě, M=rozmery závitníkov v sade, F= rozmery očiek v sade, L112 - v sade, L110 - v sade



Set

Set	A	B	M	F	L112	L110	L120
21	E100 + F100 + L112 + L110	21	E100M3NO8, E100M4NO8, E100M5NO8, E100M6NO8, E100M8NO8, E100M10NO8, E100M12NO8	F100M3, F100M4, F100M5, F100M6, F100M8, F100M10, F100M12	L112NO1.1/2, L112NO3	L1102A, L1102B, L1103, L1104, L1105	L12021
30	E100 + F100 + L112 + L110	30	E100M3NO8, E100M4NO8, E100M5NO8, E100M6NO8, E100M8NO8, E100M10NO8, E100M12NO8, E100M14NO8, E100M16NO8, E100M18NO8, E100M20NO8	F100M3, F100M4, F100M5, F100M6, F100M8, F100M10, F100M12, F100M14, F100M16, F100M18, F100M20	L112NO1.1/2, L112NO4	L1102A, L1102B, L1103, L1104, L1105, L1106	L12030
HS-2M	E500 + F300 + L112 + L110	23	E500M2NO1, E500M2NO3, E500M2.5NO1, E500M2.5NO3, E500M3NO1, E500M3NO3, E500M3.5NO1, E500M3.5NO3, E500M4NO1, E500M4NO3, E500M5NO1, E500M5NO3, E500M6NO1, E500M6NO3	F300M2X13/16, F300M2.5X13/16, F300M3X13/16, F300M3.5X13/16, F300M4X13/16, F300M5X13/16, F300M6X13/16	L112BT1	L11013/16	L1202M
HS-4M	E500 + F300 + L112 + L110	32	E500M5NO1, E500M5NO3, E500M6NO1, E500M6NO3, E500M7NO1, E500M7NO3, E500M8NO1, E500M8NO3, E500M9NO1, E500M9NO3, E500M10NO1, E500M10NO3, E500M11NO1, E500M11NO3, E500M12NO1, E500M12NO3	F300M5X13/16, F300M6X13/16, F300M7X13/16, F300M8X1.5/16, F300M9X1.5/16, F300M10X1.5/16, F300M11X1.5/16, F300M12X1.5/16, F300M5X13/16, F300M6X13/16, F300M7X13/16, F300M8X1.5/16, F300M9X1.5/16	L112BT2	L11013/16, L1101.5/16	L1204M

Set	A	B	M	F	L112	L110	L120
HS-8M	E500 + F300 + L112 + L110	17	E500M2NO1, E500M2NO3, E500M3NO1, E500M3NO3, E500M4NO1, E500M4NO3, E500M5NO1, E500M5NO3, E500M6NO1, E500M6NO3	F300M2X13/16, F300M3X13/16, F300M4X13/16, F300M5X13/16, F300M6X13/16	L112BT1	L11013/16	L1208M
HS-10M	E500 + F300 + L112 + L110	27	E500M3NO1, E500M3NO3, E500M4NO1, E500M4NO3, E500M5NO1, E500M5NO3, E500M6NO1, E500M6NO3, E500M7NO1, E500M7NO3, E500M8NO1, E500M8NO3, E500M9NO1, E500M9NO3, E500M10NO1, E500M10NO3	F300M3X13/16, F300M4X13/16, F300M5X13/16, F300M6X1, F300M7X1, F300M8X1, F300M9X1, F300M10X1	L112BT2	L11013/16, L1101INCH	L12010M
HS-12M	E500 + F300 + L112 + L110	35	E500M2NO1, E500M2NO3, E500M3NO1, E500M3NO3, E500M4NO1, E500M4NO3, E500M5NO1, E500M5NO3, E500M6NO1, E500M6NO3, E500M7NO1, E500M7NO3, E500M8NO1, E500M8NO3, E500M9NO1, E500M9NO3, E500M10NO1, E500M10NO3, E500M12NO1, E500M12NO3	F300M2X13/16, F300M3X13/16, F300M4X13/16, F300M5X13/16, F300M6X13/16, F300M7X13/16, F300M8X1, F300M9X1, F300M10X1, F300M12X1.5/16	L112BT1, L112BT2	L11013/16, L1101INCH, L1101.5/16	L12012M
HS-14M	E500 + F300 + L112 + L110	34	E500M6NO1, E500M6NO3, E500M7NO1, E500M7NO3, E500M8NO1, E500M8NO3, E500M9NO1, E500M9NO3, E500M10NO1, E500M10NO3, E500M12NO1, E500M12NO3, E500M14NO1, E500M14NO3, E500M16NO1, E500M16NO3, E500M18NO1, E500M18NO3, E500M20NO1, E500M20NO3	F300M6X1, F300M7X1, F300M8X1, F300M9X1, F300M10X1, F300M12X1.5/16, F300M14X1.5/16, F300M16X1.1/2, F300M18X1.1/2, F300M20X1.1/2	L112NO3	L1101INCH, L1101.5/16, L1101.1/2	L12014M
HS-30UNC	E515 + F320 + L112 + L110	18	E5151/2NO1, E5151/2NO3, E5151/4NO1, E5151/4NO3, E5155/16NO1, E5155/16NO3, E5153/8NO1, E5153/8NO3, E5157/16NO1, E5157/16NO3	F3201/4X1, F3205/16X1, F3207/16X1.5/16, F3203/8X1, F3201/2X1.5/16	L112BT2	L1101INCH, L1101.5/16	L12030UNC
HS-32UNC	E515 + F320 + L112 + L110	27	E5151/2NO1, E5151/2NO3, E5151/4NO1, E5151/4NO3, E5155/16NO1, E5155/16NO3, E5153/8NO1, E5153/8NO3, E5157/16NO1, E5157/16NO3, E5155/8NO1, E5155/8NO3, E5153/4NO1, E5153/4NO3	F3201/4X1, F3205/16X1, F3207/16X1.5/16, F3203/8X1, F3207/16X1.1/2, F3201/2X1.5/16, F3201/2X1.1/2, F3205/8X1.1/2, F3203/4X1.1/2	L112BT2, L112NO3	L1101INCH, L1101.1/2	L12032UNC

Set	A	B	M	F	L112	L110	L120
HS-24UNF	E524 + F330 + L112 + L110	18	E5241/2NO1, E5241/2NO3, E5241/4NO1, E5241/4NO3, E5245/16NO1, E5245/16NO3, E5243/8NO1, E5243/8NO3, E5247/16NO1, E5247/16NO3	F3301/4X1, F3305/16X1, F3307/16X1.5/16, F3303/8X1, F3301/2X1.5/16	L112BT2	L1101INCH, L1101.5/16	L12024UNF
HS-26UNF	E524 + F330 + L112 + L110	25	E5241/2NO1, E5241/2NO3, E5241/4NO1, E5241/4NO3, E5245/16NO1, E5245/16NO3, E5243/8NO1, E5243/8NO3, E5247/16NO1, E5247/16NO3, E5245/8NO1, E5245/8NO3, E5243/4NO1, E5243/4NO3	F3301/4X1, F3305/16X1, F3303/8X1, F3307/16X1.1/2, F3301/2X1.1/2, F3305/8X1.1/2, F3303/4X1.1/2	L112BT2, L112NO3	L1101INCH, L1101.1/2	L12026UNF

L110

- Vratidla pro očka
- Воротки для круглых плашек
- Uchwyt do narzynek
- Vrátidlo na zavítovacie očka



Nr.	Ø x H	L110
1"	16 x 5	L1101
2a	20 x 5	L1102A
2b	20 x 7	L1102B
3	25 x 9	L1103
4"	30 x 11	L1104
5	38 x 14	L1105
5f	38 x 10	L1105F
6	45 x 18	L1106
6f	45 x 14	L1106F
7	55 x 22	L1107
7f	55 x 16	L1107F
8	65 x 25	L1108
8f	65 x 18	L1108F
9	75 x 30	L1109
9f	75 x 20	L1109F
10	90 x 36	L11010
10f	90 x 22	L11010F
	13/16 x 1/4	L11013/16
	1 x 3/8	L1101INCH
	1.5/16 x 7/16	L1101.5/16
	1.1/2 x 1/2	L1101.1/2
	2 x 5/8	L1102INCH
	2.1/4 x 11/16	L1102.1/4
	3 x 7/8	L1103INCH
	4 x 1	L1104INCH

L112

- Vratidlo pro závitníky
- Регулируемые воротки для метчиков
- Nastawny uchwyt do gwintowników
- Vrátidlo pre závitníky

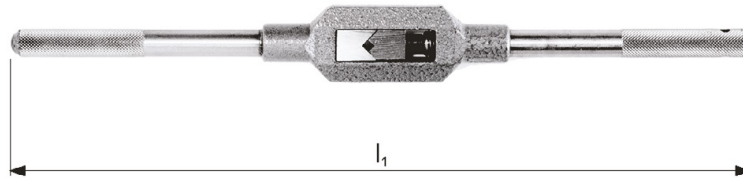

Nr.	l_1 mm	\square a mm	\square a Inch	Tap Range (M)	Tap Range (Inch)	L112
BT1	105	1.0 - 6.5	0.0394 - 0.2559	M1 - M8	No. 0 - 5/16	L112BT1
BT2	162	1.0 - 10.0	0.0394 - 0.3937	M1 - M14	No. 0 - 5/8	L112BT2
0	130	2.0 - 5.0	0.0787 - 0.1969	M1 - M5	No. 0 - 1/4	L112NO0
1.1/2	205	2.1 - 8.0	0.0827 - 0.3150	M2.2 - M12	No. 0 - 1/2	L112NO1.1/2
3	380	4.9 - 12.0	0.1929 - 0.4724	M5 - M20	5/16 - 3/4	L112NO3
4	500	5.5 - 16.0	0.2165 - 0.6299	M7 - M30	5/16 - 1"	L112NO4
6	1000	11.0 - 24.0	0.4331 - 0.9449	M18 - M42	3/4 - 1.1/2	L112NO6
7	1250	16.0 - 32.0	0.6299 - 1.2598	M27 - M48	1.1/8 - 2"	L112NO7

351 - 372



F100	355
F108	355
F110	356
F120	357
F130	358
F140	359
F150	360
F170	361
F180	362
F190	363
F201	355
F202	369
F272	372
F300	364
F302	370
F310	365
F312	371
F320	366
F330	367
F370	368

Typ závitu	Тип резьбы	Typ Gwintu	Typ závitu
Standard	Стандарт	Standard	Štandard
Tolerance	Допуск	Tolerancja	Tolerancia
Náběhy	Заборный конус	Nakrój	Náběhy
Materiál	Материал	Materiał	Materiál
Směr otáčení	Направление	Kierunek	Smer
Povlak	Покрытие	Pokrycie	Povlak
<ul style="list-style-type: none"> ■ vynikající ● dobrý Příklad 10 = řezná rychlost (m/min) +/- 10%	Основное применение Возможное применение Пример: 10 = Скорость резания в м/мин +/- 10%	Najlepsze zastosowanie Dobre zastosowanie Na Przykład 10 = prędkość skrawania w m/min +/- 10%	Vynikajúce Dobré Příklad 10 = rezná rýchlosť (m/min) +/- 10%
Kód	Код	Kod	Kód
Rozměrová řada	Ассортимент	Zakres	Rozsah rozmerov

AMG	Česky	Русский	Polski	Slovensky
1.1	magneticky měkká	Автоматная сталь	magnetyczna miękka	Magneticky mäkká oceľ
1.2	konstrukční uhlíkatá	Низкоуглеродистая сталь	konstrukcyjna do nawęglania	Konstruktčná oceľ, uhlíková
1.3	uhlíkatá	Углеродистая нелегированная сталь	węgłowa	Uhlíková oceľ
1.4	legovaná	Легированная сталь	stopowa	Legovaná oceľ
1.5	legovaná, tvrzená a temperovaná	Легированная сталь после отжига	stopowa-hartowana i odpuszczana	Legovaná oceľ, tvrdená a temperovaná
1.6	legovaná, tvrzená a temperovaná	Высоколегированная сталь после отжига	stopowa-hartowana i odpuszczana	Legovaná oceľ, tvrdená a temperovaná
1.7	legovaná, tvrzená	Легированная закаленная сталь	stopowa-hartowana	Legovaná oceľ tvrdená
1.8	legovaná, tvrzená	Легированная закаленная сталь	stopowa-hartowana	Legovaná oceľ tvrdená, oceľ odolná oproti opotrebovaniu
2.1	automatová	Ферритная нержавеющая сталь	automatowa	Automatová nehrdzavejúca oceľ
2.2	austenitická	Аустенитная нержавеющая сталь	austenityczna	Austenická
2.3	feritická+austenitická	Ферритно-аустенитная нержавеющая сталь	ferrytyczna+austenityczna	Feriticko austenitická nehr. oceľ (Duplex)
2.4	precipitačně tvrzená	Сталь дисперсионного твердения	Utwardzane wydzieleniowo	Tvrdená nehr. oceľ
3.1	lamelární	Серый чугуи	szare	Sivá liatina
3.2	lamelární	Ковкий чугуи	szare	Sivá liatina
3.3	nodulární	Высокопрочный чугуи	sferoidalne ciągliwe	Tvárná liatina
3.4	nodulární	Высокопрочный чугуи	sferoidalne ciągliwe	Tvárná liatina
4.1	čistý	Технически чистый титан	niestopowy	Čistý titán
4.2	slitiny	Титановые сплавы	stopy tytanu	Zliatiny titánu
4.3	slitiny	Титановые сплавы	stopy tytanu	Zliatiny titánu
5.1	čistý	Технически чистый никель	niestopowy	Čistý nikel
5.2	slitiny	Никелевые сплавы	stopy niklu	Zliatiny niklu
5.3	slitiny	Никелевые сплавы	stopy niklu	Zliatiny niklu
6.1	bronz	Технически чистая медь	niestopowa	Bronz
6.2	β - mosaz, bronz	Бронза	Mosiądz-β, brąz	β - mosadz, bronz
6.3	bronz mosaz	Латунь	Mosiądz CuZn	Mosadz, bronz
6.4	bronz vysokopevnostní	Высокопрочная бронза	Brąz o wysokiej wytrzymałości	Vysokopevnostný bronz
7.1	Al, Mg, tvářené	Технически чистый алюминий/магний	Al.,Mg. niestopowe	Al, Mg, tvárnený (čistý)
7.2	Al slitiny, Si<0.5%	Сплавы Al с содержанием Si<0.5%	Al. Stopowe, Si<0,5%	Al zliatiny, Si<0,5%
7.3	Al slitiny, Si>0.5%<10%	Сплавы Al с содержанием 0.5%<Si<10%	Al. Stopowe, Si>0,5%<10%	Al zliatiny, Si>0,5%<10%
7.4	Al slitiny, Si>10%	Сплавы Al с содержанием Si>10%	Al. Stopowe, Si>10%	Al zliatiny, Si>10%
8.1	termoplasty	Термопластики	Tworzywa termoplastyczne	Termoplasty
8.2	termosety	Терморезактивные полимеры	Tworzywa termoutwardzalne	Termosety
8.3	zpevněné plasty	Армированные полимеры	Zbrojone tworzywa sztuczne	Spevnené plasty
9.1	cermet (keramika)	Металлокерамика	Cermetale	Cermet (kov-keramika)
10.1	standardni grafit	Технический графит	Grafit standartowy	Grafit

M	M	M	MF	UNC	UNF	BSW	BSF	G	NPT	PG
ISO 2568	ISO 2568	ISO 2568	ISO 2568	ISO 2568	ISO 2568	ISO 2568	ISO 2568	ISO 2568	ISO 2568	ISO 2568
6g	6g	6g	6g	2A	2A	Medium	Medium	Class A	Normal	Normal
1.75XP	1.75XP	2.25XP	1.75XP	1.75XP	1.75XP	1.75XP	1.75XP	1.75XP	1.75XP	1.75XP
HSS	HSS	HSS-E	HSS	HSS	HSS	HSS	HSS	HSS	HSS	HSS

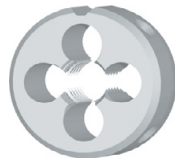

F100	F201	F108	F110	F120	F130	F140	F150	F170	F180	F190
M2 - M42	M3 - M20	M2 - M20	M4 - M40	No.8 - 1"	No.10 - 1"	1/8 - 1"	3/16 - 1/2	1/8 - 2"	1/8 - 1"	No.7 - No.36

AMG	355	355	355	356	357	358	359	360	361	362	363	ISO
1.1	■8	■8	●8	■8	■8	■8	■8	■8	■8	■8	■8	P 1
1.2	■7	■7	●7	■7	■7	■7	■7	■7	■7	■7	■7	P 1
1.3	■6	■6	■6	■6	■6	■6	■6	■6	■6	■6	■6	P 2
1.4	●5	●5	■5	●5	●5	●5	●5	●5	●5	●5	●5	P 3
1.5			●4									P 4
1.6												H 1
1.7												H 3
1.8												H 4
2.1	●4	●4	■4	●4	●4	●4	●4	●4	●4	●4	●4	M 1
2.2	●2	●2	■2	●2	●2	●2	●2	●2	●2	●2	●2	M 3
2.3			●1									M 2
2.4												S 2
3.1	■8	■8	■8	■8	■8	■8	■8	■8	■8	■8	■8	K 1
3.2	■7	■7	■7	■7	■7	■7	■7	■7	■7	■7	■7	K 2
3.3	■6	■6	■6	■6	■6	■6	■6	■6	■6	■6	■6	K 3
3.4	●5	●5	●5	●5	●5	●5	●5	●5	●5	●5	●5	K 4
4.1			●2									S 1
4.2												S 2
4.3	●2	●2	●2	●2	●2	●2	●2	●2	●2	●2	●2	S 3
5.1	●9	●9	●9	●9	●9	●9	●9	●9	●9	●9	●9	S 1
5.2	●2	●2	●2	●2	●2	●2	●2	●2	●2	●2	●2	S 2
5.3	●2	●2	●2	●2	●2	●2	●2	●2	●2	●2	●2	S 3
6.1	●9	●9	●9	●9	●9	●9	●9	●9	●9	●9	●9	N 3
6.2	●8	●8	●8	●8	●8	●8	●8	●8	●8	●8	●8	N 4
6.3	●7	●7	●7	●7	●7	●7	●7	●7	●7	●7	●7	N 3
6.4			●2									N 4
7.1	■10	■10	■10	■10	■10	■10	■10	■10	■10	■10	■10	N 1
7.2	■15	■15	■15	■15	■15	■15	■15	■15	■15	■15	■15	N 1
7.3	■15	■15	■15	■15	■15	■15	■15	■15	■15	■15	■15	N 1
7.4	●10	●10	●10	●10	●10	●10	●10	●10	●10	●10	●10	N 2
8.1	●15	●15	●15	●15	●15	●15	●15	●15	●15	●15	●15	O
8.2	●10	●10	●10	●10	●10	●10	●10	●10	●10	●10	●10	O
8.3	●5	●5	●5	●5	●5	●5	●5	●5	●5	●5	●5	O
9.1												H
10.1												O

M	MF	UNC	UNF	G	M	M	MF	G
BS 1127: 1950	BS 1127: 1950	BS 1127: 1950	BS 1127: 1950	BS 1127: 1950	DIN 382	BS 1127: 1950	BS 1127: 1950	DIN 382
1.75XP	1.75XP	1.75XP	1.75XP	1.75XP	6g	6g	6g	Class A
HSS	HSS	HSS	HSS	HSS	HSS	HSS	HSS	HSS



	F300	F310	F320	F330	F370	F202	F302	F312	F272	
	M2 - M36	M3 - M30	No.4 - 1.1/4	No.4 - 1.1/2	1/8 - 1.1/2	M3 - M36	M3 - M36	M8 - M24	1/8 - 1.1/2	
AMG	364	365	366	367	368	369	370	371	372	ISO
1.1	■8	■8	■8	■8	■8	■8	■8	■8	■8	P 1
1.2	■7	■7	■7	■7	■7	■7	■7	■7	■7	P 1
1.3	■6	■6	■6	■6	■6	■6	■6	■6	■6	P 2
1.4	●5	●5	●5	●5	●5	●5	●5	●5	●5	P 3
1.5										P 4
1.6										H 1
1.7										H 3
1.8										H 4
2.1	●4	●4	●4	●4	●4	●4	●4	●4	●4	M 1
2.2	●2	●2	●2	●2	●2	●2	●2	●2	●2	M 3
2.3										M 2
2.4										S 2
3.1	■8	■8	■8	■8	■8	■8	■8	■8	■8	K 1
3.2	■7	■7	■7	■7	■7	■7	■7	■7	■7	K 2
3.3	■6	■6	■6	■6	■6	■6	■6	■6	■6	K 3
3.4	●5	●5	●5	●5	●5	●5	●5	●5	●5	K 4
4.1										S 1
4.2										S 2
4.3	●2	●2	●2	●2	●2	●2	●2	●2	●2	S 3
5.1	●9	●9	●9	●9	●9	●9	●9	●9	●9	S 1
5.2	●2	●2	●2	●2	●2	●2	●2	●2	●2	S 2
5.3	●2	●2	●2	●2	●2	●2	●2	●2	●2	S 3
6.1	●9	●9	●9	●9	●9	●9	●9	●9	●9	N 3
6.2	●8	●8	●8	●8	●8	●8	●8	●8	●8	N 4
6.3	●7	●7	●7	●7	●7	●7	●7	●7	●7	N 3
6.4										N 4
7.1	■10	■10	■10	■10	■10	■10	■10	■10	■10	N 1
7.2	■15	■15	■15	■15	■15	■15	■15	■15	■15	N 1
7.3	■15	■15	■15	■15	■15	■15	■15	■15	■15	N 1
7.4	●10	●10	●10	●10	●10	●10	●10	●10	●10	N 2
8.1	●15	●15	●15	●15	●15	●15	●15	●15	●15	O
8.2	●10	●10	●10	●10	●10	●10	●10	●10	●10	O
8.3	●5	●5	●5	●5	●5	●5	●5	●5	●5	O
9.1										H
10.1										O

- F100** • M Závítovací očka
F201 • M Круглые плашки
F108 • M Narzynka metryczna
 • M Závítovacie očka

F100; F201	▪	1.1	1.2	1.3	3.1	3.2	3.3	7.1	7.2	7.3											
	•	1.4	2.1	2.2	3.4	4.3	5.1	5.2	5.3	6.1	6.2	6.3	7.4	8.1	8.2	8.3					
F108	▪	1.3	1.4	2.1	2.2	3.1	3.2	3.3	7.1	7.2	7.3										
	•	1.1	1.2	1.5	2.3	3.4	4.1	4.3	5.1	5.2	5.3	6.1	6.2	6.3	6.4	7.4	8.1	8.2	8.3		

F100	M	ISO 2568	6g	1.75XP	HSS			
F201	M	ISO 2568	6g	1.75XP	HSS			
F108	M	ISO 2568	6g	2.25XP	HSS-E			

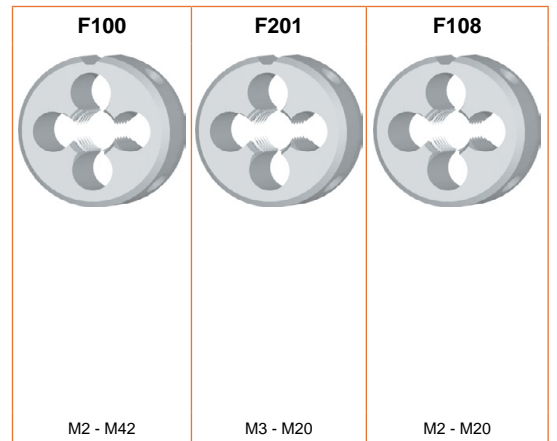
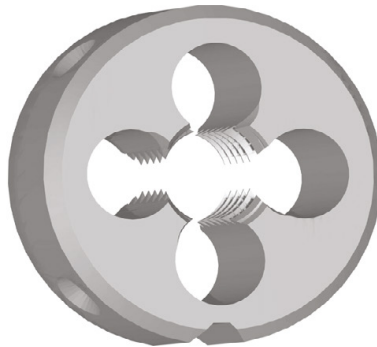
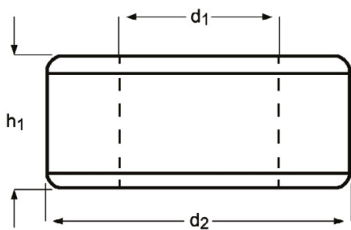

M	P mm	d ₂ ∅ mm	h ₁ mm	F100	F201	F108
2	0.40	16	5	F100M2 ¹⁾		F108M2 ¹⁾
2.5	0.45	16	5	F100M2.5 ¹⁾		F108M2.5 ¹⁾
2.6	0.45	16	5	F100M2.6 ¹⁾		
3	0.50	20	5	F100M3	F201M3	F108M3
3.5	0.60	20	5	F100M3.5		
4	0.70	20	5	F100M4	F201M4	F108M4
4.5	0.75	20	7	F100M4.5		
5	0.80	20	7	F100M5	F201M5	F108M5
6	1.00	20	7	F100M6	F201M6	F108M6
7	1.00	25	9	F100M7		
8	1.25	25	9	F100M8	F201M8	F108M8
9	1.25	25	9	F100M9		
10	1.50	30	11	F100M10	F201M10	F108M10
11	1.50	30	11	F100M11		
12	1.75	38	14	F100M12	F201M12	F108M12
14	2.00	38	14	F100M14	F201M14	F108M14
16	2.00	45	18	F100M16	F201M16	F108M16
18	2.50	45	18	F100M18	F201M18	F108M18
20	2.50	45	18	F100M20	F201M20	F108M20
22	2.50	55	22	F100M22		
24	3.00	55	22	F100M24		
27	3.00	65	25	F100M27		
30	3.50	65	25	F100M30		
33	3.50	65	25	F100M33		
36	4.00	65	25	F100M36		
39	4.00	75	30	F100M39		
42	4.50	75	30	F100M42		

¹⁾ bez lamače třísek / Без спиральной подточки / Bez prowadzenia / Bez lamača triesok

F110

- MF Závitovací očka
- MF Круглые плашки
- MF Narzynka drobnozwojna
- MF Závitovacie očka

F110	▪	1.1	1.2	1.3	3.1	3.2	3.3	7.1	7.2	7.3						
	•	1.4	2.1	2.2	3.4	4.3	5.1	5.2	5.3	6.1	6.2	6.3	7.4	8.1	8.2	8.3

F110 MF ISO 2568 6g 1.75XP HSS

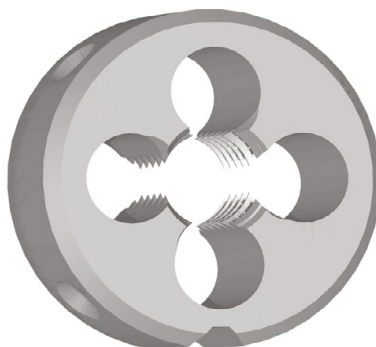
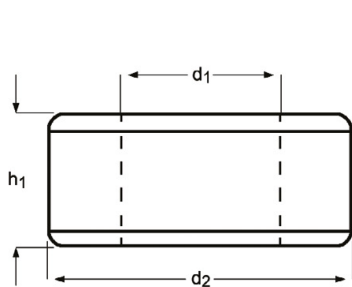

MF	P mm	d ₂ Ø mm	h ₁ mm	F110
4	0.50	20	5	F110M4X.5
5	0.50	20	5	F110M5X.5
6	0.75	20	7	F110M6X.75
7	0.75	25	9	F110M7X.75
8	0.75	25	9	F110M8X.75
8	1.00	25	9	F110M8X1.0
9	1.00	25	9	F110M9X1.0
10	0.75	30	11	F110M10X.75
10	1.00	30	11	F110M10X1.0
10	1.25	30	11	F110M10X1.25
11	1.00	30	11	F110M11X1.0
12	1.00	38	10	F110M12X1.0
12	1.25	38	10	F110M12X1.25
12	1.50	38	10	F110M12X1.5
13	1.00	38	10	F110M13X1.0
14	1.00	38	10	F110M14X1.0
14	1.25	38	10	F110M14X1.25
14	1.50	38	10	F110M14X1.5
15	1.00	38	10	F110M15X1.0
15	1.50	38	10	F110M15X1.5
16	1.00	45	14	F110M16X1.0
16	1.50	45	14	F110M16X1.5
18	1.00	45	14	F110M18X1.0
18	1.50	45	14	F110M18X1.5
20	1.00	45	14	F110M20X1.0
20	1.50	45	14	F110M20X1.5
22	1.00	55	16	F110M22X1.0
22	1.50	55	16	F110M22X1.5
24	1.00	55	16	F110M24X1.0
24	1.50	55	16	F110M24X1.5
24	2.00	55	16	F110M24X2.0
25	1.50	55	16	F110M25X1.5
26	1.50	55	16	F110M26X1.5
27	1.50	65	18	F110M27X1.5
27	2.00	65	18	F110M27X2.0
28	1.50	65	18	F110M28X1.5
30	1.50	65	18	F110M30X1.5
32	1.50	65	18	F110M32X1.5
35	1.50	65	18	F110M35X1.5
36	1.50	65	18	F110M36X1.5
40	1.50	75	20	F110M40X1.5

F120

- UNC Závitovací očka
- UNC Круглые плашки
- UNC Narzynka drobnozwojna
- UNC Závitovacie očka

F120	▪	1.1	1.2	1.3	3.1	3.2	3.3	7.1	7.2	7.3								
	•	1.4	2.1	2.2	3.4	4.3	5.1	5.2	5.3	6.1	6.2	6.3	7.4	8.1	8.2	8.3		

F120 **UNC** **ISO 2568** **2A** **1.75XP** **HSS**

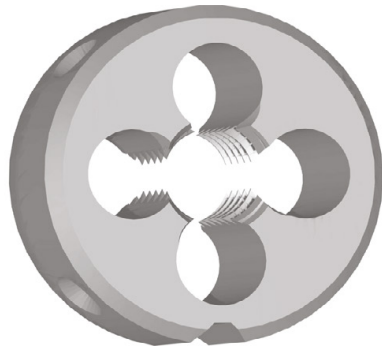
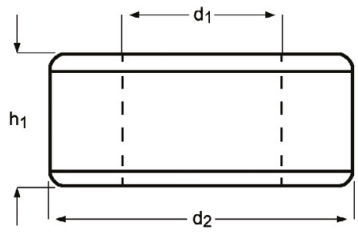

UNC	TPI	d_1 nom mm	d_2 \varnothing mm	h_1 mm	F120
8	32	4.17	20	7	F1208-32
10	24	4.83	20	7	F12010-24
1/4	20	6.35	20	7	F1201/4
5/16	18	7.94	25	9	F1205/16
3/8	16	9.53	30	11	F1203/8
7/16	14	11.11	30	11	F1207/16
1/2	13	12.70	38	14	F1201/2
9/16	12	14.29	38	14	F1209/16
5/8	11	15.88	45	18	F1205/8
3/4	10	19.05	45	18	F1203/4
7/8	9	22.23	55	22	F1207/8
1"	8	25.40	55	22	F1201

F130

- UNF Závıtovacı očka
- UNF Круглые плашки
- UNF Narzynka
- UNF Závıtovacıe očka

F130	▪	1.1	1.2	1.3	3.1	3.2	3.3	7.1	7.2	7.3						
	•	1.4	2.1	2.2	3.4	4.3	5.1	5.2	5.3	6.1	6.2	6.3	7.4	8.1	8.2	8.3

F130 **UNF** **ISO 2568** **2A** **1.75XP** **HSS**  

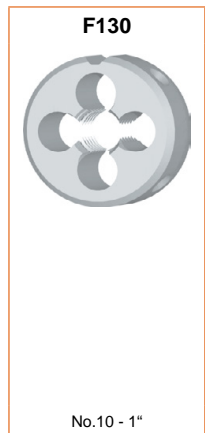
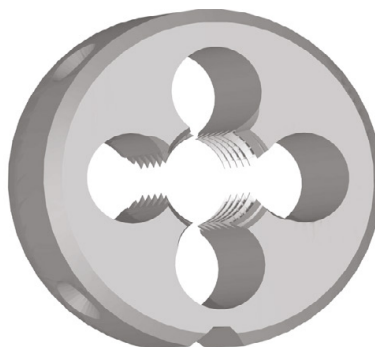
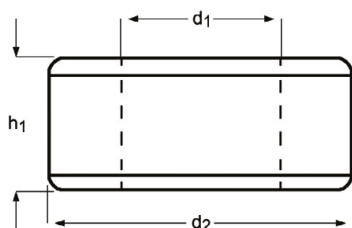

UNF	TPI	d_1 nom mm	d_2 \varnothing mm	h_1 mm	F130
10	32	4.83	20	7	F13010-32
1/4	28	6.35	20	7	F1301/4
5/16	24	7.94	25	9	F1305/16
3/8	24	9.53	30	11	F1303/8
7/16	20	11.11	30	11	F1307/16
1/2	20	12.70	38	10	F1301/2
9/16	18	14.29	38	10	F1309/16
5/8	18	15.88	45	14	F1305/8
3/4	16	19.05	45	14	F1303/4
7/8	14	22.23	55	16	F1307/8
1"	12	25.40	55	16	F1301

F140

- BSW Závitovací očka
- BSW Круглые плашки
- BSW Narzynka
- BSW Závitovacie očka

F140	▪	1.1	1.2	1.3	3.1	3.2	3.3	7.1	7.2	7.3								
	•	1.4	2.1	2.2	3.4	4.3	5.1	5.2	5.3	6.1	6.2	6.3	7.4	8.1	8.2	8.3		

F140 **BSW** **ISO 2568** Medium **1.75XP** **HSS**

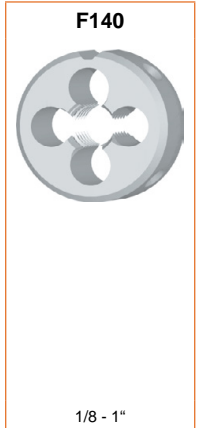
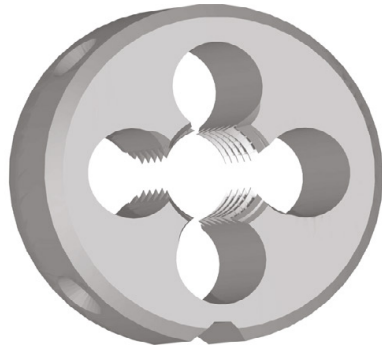
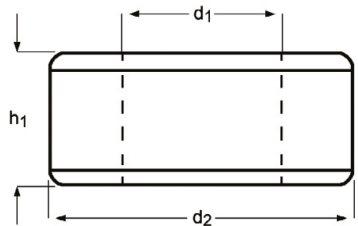

BSW	TPI	d_1 nom mm	d_2 Ø mm	h_1 mm	F140
1/8	40	3.17	20	5	F1401/8
3/16	24	4.76	20	7	F1403/16
1/4	20	6.35	20	7	F1401/4
5/16	18	7.94	25	9	F1405/16
3/8	16	9.53	30	11	F1403/8
7/16	14	11.11	30	11	F1407/16
1/2	12	12.70	38	14	F1401/2
5/8	11	15.88	45	18	F1405/8
3/4	10	19.05	45	18	F1403/4
7/8	9	22.23	55	22	F1407/8
1"	8	25.40	55	22	F1401

- F150**
- BSF Závitovací očka
 - BSF Круглые плашки
 - BSF Narzynka
 - BSF Závitovacie očka

F150	▪	1.1	1.2	1.3	3.1	3.2	3.3	7.1	7.2	7.3						
	•	1.4	2.1	2.2	3.4	4.3	5.1	5.2	5.3	6.1	6.2	6.3	7.4	8.1	8.2	8.3

F150 **BSF** **ISO 2568** Medium **1.75XP** **HSS**  

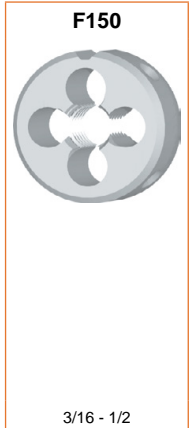
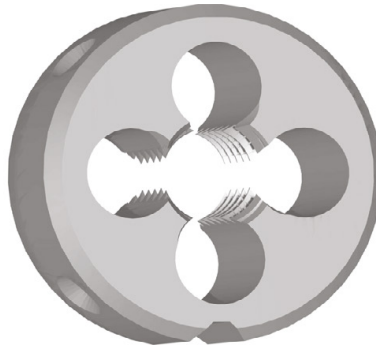
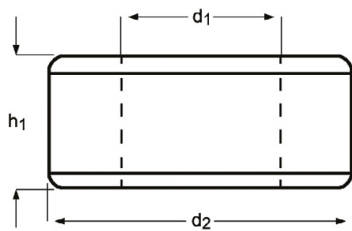

BSF	TPI	d_1 nom mm	d_2 Ø mm	h_1 mm	F150
3/16	32	4.76	20	7	F1503/16
1/4	26	6.35	20	7	F1501/4
5/16	22	7.94	25	9	F1505/16
3/8	20	9.53	30	11	F1503/8
7/16	18	11.11	30	11	F1507/16
1/2	16	12.70	38	10	F1501/2

F170

- G(BSP) Závitovací očka
- G(BSP) Круглые плашки
- G(BSP) Narzynka
- G(BSP) Závitovacie očka

F170	▪	1.1	1.2	1.3	3.1	3.2	3.3	7.1	7.2	7.3						
	•	1.4	2.1	2.2	3.4	4.3	5.1	5.2	5.3	6.1	6.2	6.3	7.4	8.1	8.2	8.3

F170 **G** **ISO 2568** **Class A** **1.75XP** **HSS**

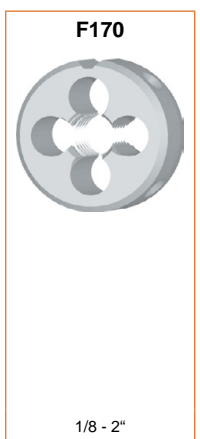
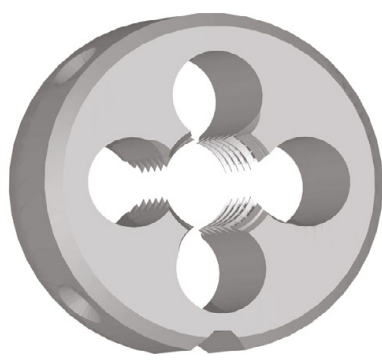
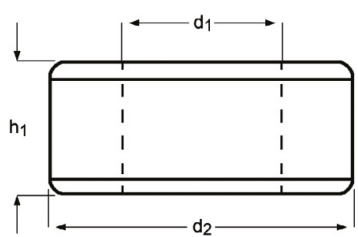

G(BSP)	TPI	d_1 nom mm	d_2 Ø mm	h_1 mm	F170
1/8	28	9.73	30	11	F1701/8
1/4	19	13.16	38	10	F1701/4
3/8	19	16.66	45	14	F1703/8
1/2	14	20.96	45	14	F1701/2
5/8	14	22.91	55	16	F1705/8
3/4	14	26.44	55	16	F1703/4
7/8	14	30.20	65	18	F1707/8
1"	11	33.25	65	18	F1701
1.1/8	11	37.89	75	20	F1701.1/8
1.1/4	11	41.91	75	20	F1701.1/4
1.1/2	11	47.80	90	22	F1701.1/2
2"	11	59.61	105	22	F1702

F180

- NPT Závitovací očka
- NPT Круглые плашки
- NPT Narzynka
- NPT Závitovacie očka

F180	▪	1.1	1.2	1.3	3.1	3.2	3.3	7.1	7.2	7.3						
	•	1.4	2.1	2.2	3.4	4.3	5.1	5.2	5.3	6.1	6.2	6.3	7.4	8.1	8.2	8.3

F180 **NPT** **ISO 2568** Normal **1.75XP** **HSS**  

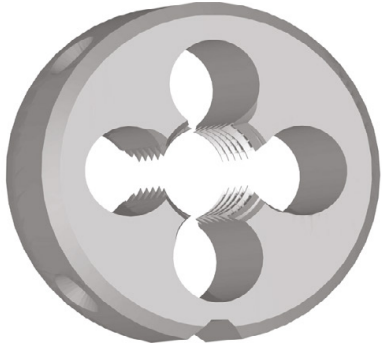
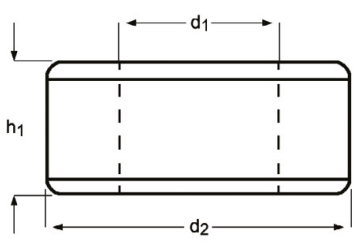

NPT	TPI	d_1 nom mm	d_2 Ø mm	h_1 mm	F180
1/8	27	9.49	30	11	F1801/8
1/4	18	12.49	38	14	F1801/4
3/8	18	15.93	45	14	F1803/8
1/2	14	19.77	45	18	F1801/2
3/4	14	25.12	55	22	F1803/4
1"	11.5	31.46	65	25	F1801

F190

- PG Závitovací očka
- PG Круглые плашки
- PG Narzynka
- PG Závitovacie očká

F190	▪	1.1	1.2	1.3	3.1	3.2	3.3	7.1	7.2	7.3						
	•	1.4	2.1	2.2	3.4	4.3	5.1	5.2	5.3	6.1	6.2	6.3	7.4	8.1	8.2	8.3

F190 **PG** **ISO 2568** Normal **1.75XP** **HSS**

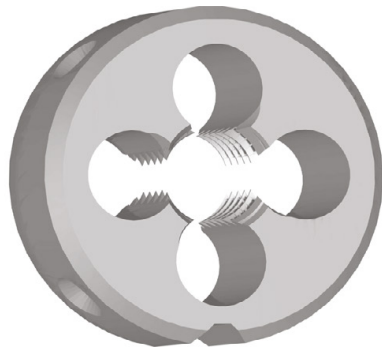
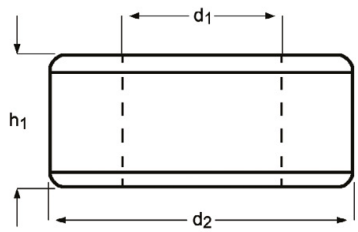

PG	TPI	d ₁ nom mm	d ₂ ∅ mm	h ₁ mm	F190
7	20	12.5	38	10	F190PG7
9	18	15.2	38	10	F190PG9
11	18	18.6	45	14	F190PG11
13.5	18	20.4	45	14	F190PG13.5
16	18	22.5	55	16	F190PG16
21	16	28.3	65	18	F190PG21
29	16	37.0	65	18	F190PG29
36	16	47.0	90	22	F190PG36

- F300**
- M Závit. očka staviteľná
 - M Регулируемые плашки
 - M Narzynka nastawna
 - M Závit. očká nastaviteľné

F300	▪	1.1	1.2	1.3	3.1	3.2	3.3	7.1	7.2	7.3						
	•	1.4	2.1	2.2	3.4	4.3	5.1	5.2	5.3	6.1	6.2	6.3	7.4	8.1	8.2	8.3

F300 **M** BS 1127: 1950 1.75XP HSS   L120 339

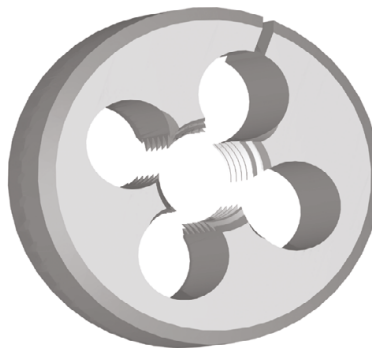
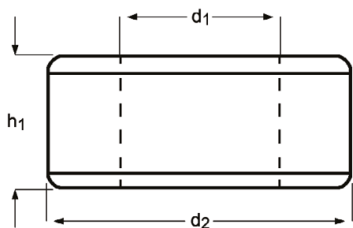

M	P mm	d ₂ Ø Inch	h ₁ Inch	F300
2	0.40	13/16	1/4	F300M2X13/16
2.5	0.45	13/16	1/4	F300M2.5X13/16
3	0.50	13/16	1/4	F300M3X13/16
3.5	0.60	13/16	1/4	F300M3.5X13/16
4	0.70	13/16	1/4	F300M4X13/16
5	0.80	13/16	1/4	F300M5X13/16
5	0.80	1"	3/8	F300M5X1
6	1.00	13/16	1/4	F300M6X13/16
6	1.00	1"	3/8	F300M6X1
6	1.00	1.5/16	7/16	F300M6X1.5/16
7	1.00	13/16	1/4	F300M7X13/16
7	1.00	1"	3/8	F300M7X1
8	1.25	1"	3/8	F300M8X1
8	1.25	1.5/16	7/16	F300M8X1.5/16
9	1.25	1"	3/8	F300M9X1
9	1.25	1.5/16	7/16	F300M9X1.5/16
10	1.50	1"	3/8	F300M10X1
10	1.50	1.5/16	7/16	F300M10X1.5/16
10	1.50	1.1/2	1/2	F300M10X1.1/2
11	1.50	1.5/16	7/16	F300M11X1.5/16
12	1.75	1.5/16	7/16	F300M12X1.5/16
12	1.75	1.1/2	1/2	F300M12X1.1/2
14	2.00	1.5/16	7/16	F300M14X1.5/16
14	2.00	1.1/2	1/2	F300M14X1.1/2
16	2.00	1.1/2	1/2	F300M16X1.1/2
16	2.00	2"	5/8	F300M16X2
18	2.50	1.1/2	1/2	F300M18X1.1/2
18	2.50	2"	5/8	F300M18X2
20	2.50	1.1/2	1/2	F300M20X1.1/2
20	2.50	2"	5/8	F300M20X2
22	2.50	2"	5/8	F300M22X2
24	3.00	2"	5/8	F300M24X2
27	3.00	3"	7/8	F300M27X3
30	3.50	3"	7/8	F300M30X3
36	4.00	3"	7/8	F300M36X3

F310

- MF Závit. očka staviteľná
- MF Регулируемые плашки
- MF Narzynka nastawna
- MF Závit. očká nastaviteľné

F310	▪	1.1	1.2	1.3	3.1	3.2	3.3	7.1	7.2	7.3						
	•	1.4	2.1	2.2	3.4	4.3	5.1	5.2	5.3	6.1	6.2	6.3	7.4	8.1	8.2	8.3

F310 MF BS 1127: 1950 1.75XP HSS

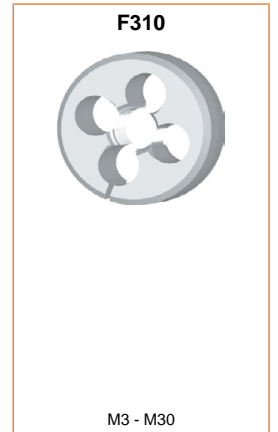
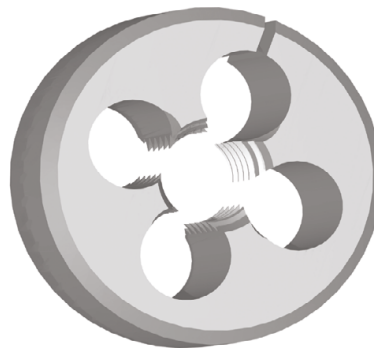
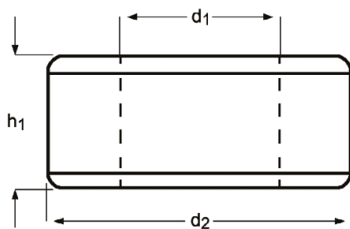

MF	P mm	d ₂ Ø Inch	h ₁ Inch	F310
3	0.35	13/16	1/4	F310M3X.35X13/16
4	0.50	13/16	1/4	F310M4X.5X13/16
4	0.75	13/16	1/4	F310M4X.75X13/16
5	0.50	13/16	1/4	F310M5X.5X13/16
5	0.90	13/16	1/4	F310M5X.9X13/16
6	0.75	13/16	1/4	F310M6X.75X13/16
8	0.75	1"	3/8	F310M8X.75X1
8	1.00	1"	3/8	F310M8X1.0X1
9	1.00	1"	3/8	F310M9X1.0X1
10	0.75	1"	3/8	F310M10X.75X1
10	1.00	1"	3/8	F310M10X1.0X1
10	1.25	1"	3/8	F310M10X1.25X1
10	1.25	1.5/16	7/16	F310M10X1.25X1.5/16
12	1.00	1.5/16	7/16	F310M12X1.0X1.5/16
12	1.25	1.5/16	7/16	F310M12X1.25X1.5/16
12	1.50	1.5/16	7/16	F310M12X1.5X1.5/16
14	1.25	1.5/16	7/16	F310M14X1.25X1.5/16
14	1.50	1.5/16	7/16	F310M14X1.5X1.5/16
16	1.00	1.1/2	1/2	F310M16X1.0X1.1/2
16	1.50	1.1/2	1/2	F310M16X1.5X1.1/2
18	1.50	1.1/2	1/2	F310M18X1.5X1.1/2
20	1.00	1.1/2	1/2	F310M20X1.0X1.1/2
20	1.50	2"	5/8	F310M20X1.5X2
20	2.00	1.1/2	1/2	F310M20X2.0X1.1/2
22	1.50	2"	5/8	F310M22X1.5X2
24	1.50	2"	5/8	F310M24X1.5X2
24	2.00	2"	5/8	F310M24X2.0X2
25	1.50	2"	5/8	F310M25X1.5X2
27	2.00	2.1/4	11/16	F310M27X2.0X2.1/4
30	2.00	2.1/4	11/16	F310M30X2.0X2.1/4

- F320**
- UNC Závit. očka staviteľná
 - UNC Регулируемые плашки
 - UNC Narzynka nastawna
 - UNC Závit. očká nastaviteľné

F320	▪	1.1	1.2	1.3	3.1	3.2	3.3	7.1	7.2	7.3										
	•	1.4	2.1	2.2	3.4	4.3	5.1	5.2	5.3	6.1	6.2	6.3	7.4	8.1	8.2	8.3				

F320 **UNC** **BS 1127: 1950** **1.75XP** **HSS**   

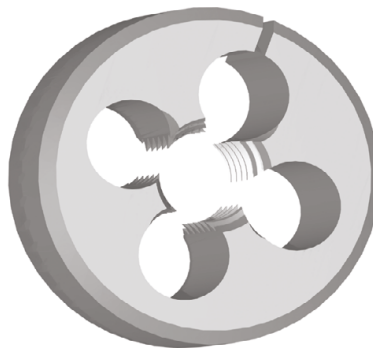
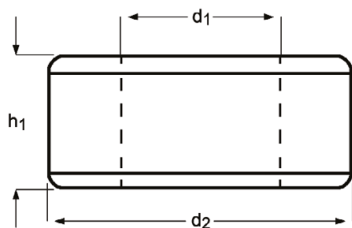

UNC	TPI	d_1 nom mm	d_2 Ø Inch	h_1 Inch	F320
4	40	2.85	13/16	1/4	F3204-40X13/16
5	40	3.18	13/16	1/4	F3205-40X13/16
6	32	3.51	13/16	1/4	F3206-32X13/16
8	32	4.17	13/16	1/4	F3208-32X13/16
8	32	4.17	1"	3/8	F3208-32X1
10	24	4.83	13/16	1/4	F32010-24X13/16
10	24	4.83	1"	3/8	F32010-24X1
12	24	5.49	13/16	1/4	F32012-24X13/16
1/4	20	6.35	13/16	1/4	F3201/4X13/16
1/4	20	6.35	1"	3/8	F3201/4X1
1/4	20	6.35	1.5/16	7/16	F3201/4X1.5/16
1/4	20	6.35	1.1/2	1/2	F3201/4X1.1/2
5/16	18	7.94	1"	3/8	F3205/16X1
5/16	18	7.94	1.1/2	1/2	F3205/16X1.1/2
3/8	16	9.53	1"	3/8	F3203/8X1
3/8	16	9.53	1.5/16	7/16	F3203/8X1.5/16
3/8	16	9.53	1.1/2	1/2	F3203/8X1.1/2
7/16	14	11.11	1.5/16	7/16	F3207/16X1.5/16
7/16	14	11.11	1.1/2	1/2	F3207/16X1.1/2
1/2	13	12.70	1.5/16	7/16	F3201/2X1.5/16
1/2	13	12.70	1.1/2	1/2	F3201/2X1.1/2
1/2	13	12.70	2"	5/8	F3201/2X2
9/16	12	14.29	1.1/2	1/2	F3209/16X1.1/2
5/8	11	15.88	1.1/2	1/2	F3205/8X1.1/2
5/8	11	15.88	2"	5/8	F3205/8X2
3/4	10	19.05	1.1/2	1/2	F3203/4X1.1/2
3/4	10	19.05	2"	5/8	F3203/4X2
7/8	9	22.23	2"	5/8	F3207/8X2
1"	8	25.40	2"	5/8	F3201X2
1.1/8	7	28.58	3"	7/8	F3201.1/8X3
1.1/4	7	31.75	3"	7/8	F3201.1/4X3

- F330**
- UNF Závit. očka staviteľná
 - UNF Регулируемые плашки
 - UNF Narzynka nastawna
 - UNF Závit. očka nastaviteľné

F330	▪	1.1	1.2	1.3	3.1	3.2	3.3	7.1	7.2	7.3						
	•	1.4	2.1	2.2	3.4	4.3	5.1	5.2	5.3	6.1	6.2	6.3	7.4	8.1	8.2	8.3

F330 UNF BS 1127: 1950 1.75XP HSS L120 339

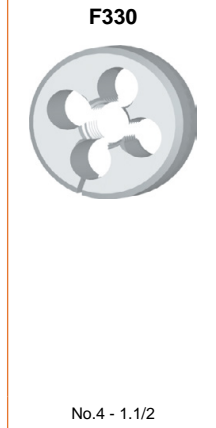
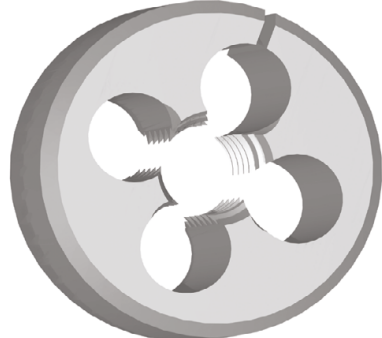
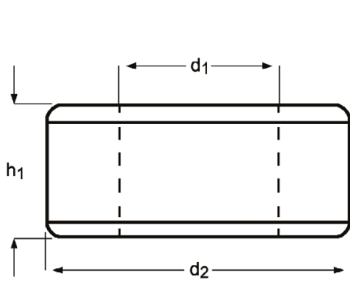

UNF	TPI	d ₁ nom mm	d ₂ Ø Inch	h ₁ Inch	F330
4	48	2.85	13/16	1/4	F3304-48X13/16
5	44	3.18	13/16	1/4	F3305-44X13/16
6	40	3.51	13/16	1/4	F3306-40X13/16
8	36	4.17	13/16	1/4	F3308-36X13/16
10	32	4.83	13/16	1/4	F33010-32X13/16
10	32	4.83	1"	3/8	F33010-32X1
12	28	5.49	13/16	1/4	F33012-28X13/16
1/4	28	6.35	13/16	1/4	F3301/4X13/16
1/4	28	6.35	1"	3/8	F3301/4X1
1/4	28	6.35	1.1/2	1/2	F3301/4X1.1/2
5/16	24	7.94	1"	3/8	F3305/16X1
5/16	24	7.94	1.5/16	7/16	F3305/16X1.5/16
5/16	24	7.94	1.1/2	1/2	F3305/16X1.1/2
3/8	24	9.53	1"	3/8	F3303/8X1
3/8	24	9.53	1.5/16	7/16	F3303/8X1.5/16
3/8	24	9.53	1.1/2	1/2	F3303/8X1.1/2
7/16	20	11.11	1"	3/8	F3307/16X1
7/16	20	11.11	1.5/16	7/16	F3307/16X1.5/16
7/16	20	11.11	1.1/2	1/2	F3307/16X1.1/2
1/2	20	12.70	1.5/16	7/16	F3301/2X1.5/16
1/2	20	12.70	1.1/2	1/2	F3301/2X1.1/2
9/16	18	14.29	1.5/16	7/16	F3309/16X1.5/16
9/16	18	14.29	1.1/2	1/2	F3309/16X1.1/2
5/8	18	15.88	1.1/2	1/2	F3305/8X1.1/2
5/8	18	15.88	2"	5/8	F3305/8X2
3/4	16	19.05	1.1/2	1/2	F3303/4X1.1/2
3/4	16	19.05	2"	5/8	F3303/4X2
7/8	14	22.23	2"	5/8	F3307/8X2
1"	12	25.40	2"	5/8	F3301X2
1.1/8	12	28.58	3"	7/8	F3301.1/8X3
1.1/4	12	31.75	3"	7/8	F3301.1/4X3
1.1/2	12	38.10	3"	7/8	F3301.1/2X3

- F370**
- G(BSP) Závit. očka staviteľná
 - G(BSP) Регулируемые плашки
 - G(BSP) Narzynka nastawna
 - G(BSP) Závit. očká nastaviteľné

F370	▪	1.1	1.2	1.3	3.1	3.2	3.3	7.1	7.2	7.3					
	•	1.4	2.1	2.2	3.4	4.3	5.1	5.2	5.3	6.1	6.2	6.3	7.4	8.1	8.2

F370 **G** BS **1127:1950** **1.75XP** **HSS**  

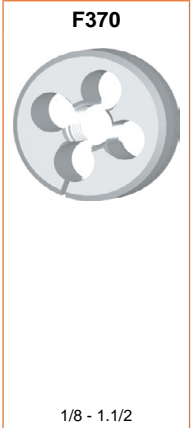
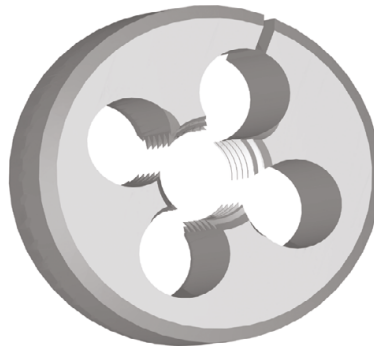
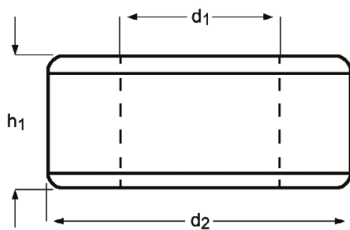

G(BSP)	TPI	d_1 nom mm	d_2 \emptyset Inch	h_1 Inch	F370
1/8	28	9.73	1"	3/8	F3701/8X1
1/4	19	13.16	1.5/16	7/16	F3701/4X1.5/16
3/8	19	16.66	1.1/2	1/2	F3703/8X1.1/2
1/2	14	20.96	2"	5/8	F3701/2X2
5/8	14	22.91	2"	5/8	F3705/8X2
3/4	14	26.44	2"	5/8	F3703/4X2
7/8	14	30.20	2.1/4	11/16	F3707/8X2.1/4
1"	11	33.25	2.1/4	11/16	F3701X2.1/4
1.1/4	11	41.91	3"	7/8	F3701.1/4X3
1.1/2	11	47.80	4"	1"	F3701.1/2X4

F202

- M Očka maticová
- M Шестигранные плашки
- M Narzynka sześciokątna
- M Očka maticové

F202	▪	1.1	1.2	1.3	3.1	3.2	3.3	7.1	7.2	7.3						
	•	1.4	2.1	2.2	3.4	4.3	5.1	5.2	5.3	6.1	6.2	6.3	7.4	8.1	8.2	8.3

F202 **M** **DIN 382** **6g** **1.75XP** **HSS**

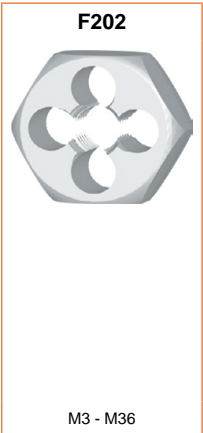
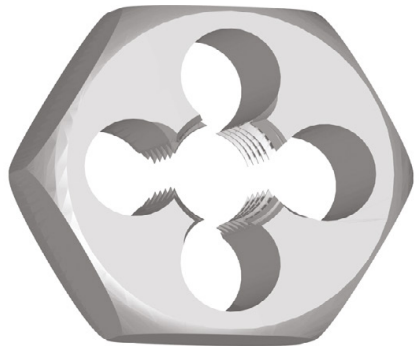
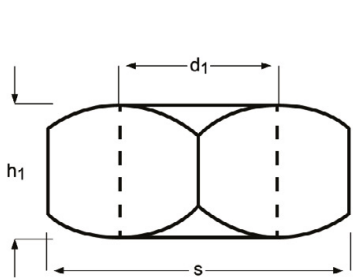

M	P mm	S mm	h ₁ mm	F202
3	0.50	19	5	F202M3
4	0.70	19	5	F202M4
5	0.80	19	7	F202M5
6	1.00	19	7	F202M6
7	1.00	22	9	F202M7
8	1.25	22	9	F202M8
10	1.50	27	11	F202M10
12	1.75	36	14	F202M12
14	2.00	36	14	F202M14
16	2.00	41	18	F202M16
18	2.50	41	18	F202M18
20	2.50	41	18	F202M20
22	2.50	50	22	F202M22
24	3.00	50	22	F202M24
27	3.00	60	25	F202M27
30	3.50	60	25	F202M30
36	4.00	60	25	F202M36

F302

- M Očka maticová
- M Шестигранные плашки
- M Narzynka sześciokątna
- M Očka maticové

F302	▪	1.1	1.2	1.3	3.1	3.2	3.3	7.1	7.2	7.3						
	•	1.4	2.1	2.2	3.4	4.3	5.1	5.2	5.3	6.1	6.2	6.3	7.4	8.1	8.2	8.3

F302

M

BS
1127:
1950

6g

1.75XP

HSS

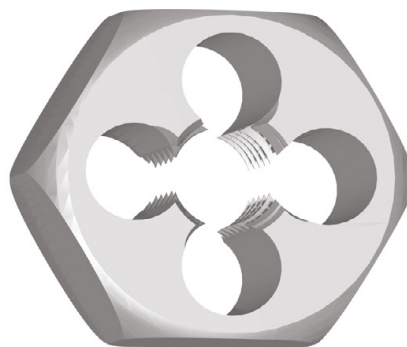
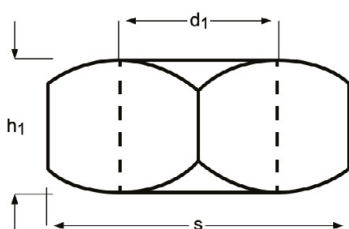

F302

M3 - M36

M	P mm	S decimal Inch	h ₁ Inch	F302
3	0.50	0.7100	1/4	F302M3
4	0.70	0.7100	1/4	F302M4
5	0.80	0.7100	1/4	F302M5
6	1.00	0.7100	1/4	F302M6
7	1.00	0.8200	5/16	F302M7
8	1.25	0.8200	5/16	F302M8
10	1.50	0.9200	3/8	F302M10
11	1.50	1.0100	7/16	F302M11
12	1.75	1.1000	1/2	F302M12
14	2.00	1.3000	5/8	F302M14
16	2.00	1.3000	5/8	F302M16
18	2.50	1.4800	11/16	F302M18
20	2.50	1.4800	11/16	F302M20
22	2.50	1.6700	13/16	F302M22
24	3.00	2.0500	15/16	F302M24
27	3.00	2.2200	1.1/16	F302M27
30	3.50	2.2200	1.1/16	F302M30
33	3.50	2.5800	1.1/8	F302M33
36	4.00	2.7600	1.1/4	F302M36

F312

- MF Očka maticová
- MF Шестигранные плашки
- MF Narzynka drobnozwojna sześciokątna
- MF Očka maticové

F312	▪	1.1	1.2	1.3	3.1	3.2	3.3	7.1	7.2	7.3						
	•	1.4	2.1	2.2	3.4	4.3	5.1	5.2	5.3	6.1	6.2	6.3	7.4	8.1	8.2	8.3

F312 MF BS 1127: 1950 6g 1.75XP HSS

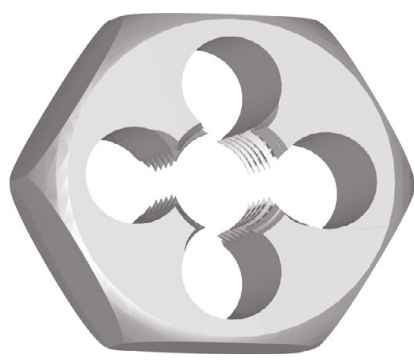
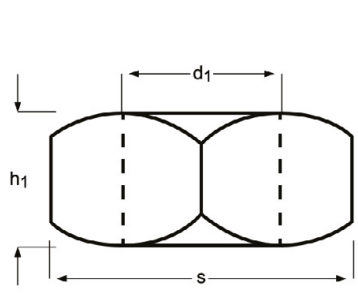

MF	P mm	S decimal Inch	h ₁ Inch	F312
8	0.75	0.8200	5/16	F312M8X.75
8	1.00	0.8200	5/16	F312M8X1.0
10	1.00	0.9200	3/8	F312M10X1.0
10	1.25	0.9200	3/8	F312M10X1.25
12	1.00	1.0100	7/16	F312M12X1.0
12	1.25	1.0100	7/16	F312M12X1.25
12	1.50	1.0100	7/16	F312M12X1.5
14	1.50	1.3000	5/8	F312M14X1.5
16	1.50	1.3000	5/8	F312M16X1.5
18	1.50	1.4800	11/16	F312M18X1.5
20	1.50	1.4800	11/16	F312M20X1.5
22	1.50	1.6700	13/16	F312M22X1.5
24	1.50	2.0500	15/16	F312M24X1.5
24	2.00	2.0500	15/16	F312M24X2.0

- F272**
- G(BSP) Závité očko / závité kruhová čelist - matice
 - G(BSP) Шестигранные плашки
 - G(BSP) Narzynka sześciokątna
 - G(BSP) Závité očko - maticové

F272	▪	1.1	1.2	1.3	3.1	3.2	3.3	7.1	7.2	7.3									
	•	1.4	2.1	2.2	3.4	4.3	5.1	5.2	5.3	6.1	6.2	6.3	7.4	8.1	8.2	8.3			

F272	G	DIN 382	Class A	1.75XP	HSS		
------	---	---------	---------	--------	-----	---	---

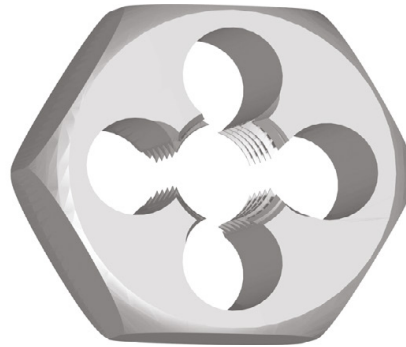
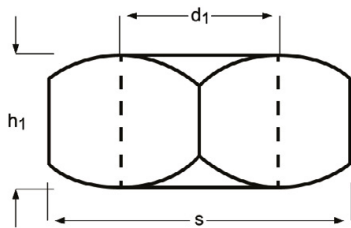

G(BSP)	TPI	d_1 nom mm	S mm	h_1 mm	F272
1/8	28	9.73	27	11	F2721/8
1/4	19	13.16	36	10	F2721/4
3/8	19	16.66	41	14	F2723/8
1/2	14	20.96	41	14	F2721/2
3/4	14	26.44	60	18	F2723/4
1"	11	33.25	60	18	F2721
1.1/4	11	41.91	70	20	F2721.1/4
1.1/2	11	47.80	85	22	F2721.1/2

C110	443	C831	482	S525	417	S813HA	394
C122	454	C835	480	S526	418	S813HB	394
C123	445	C837	479	S527	419	S814HA	408
C126	443	C907	456	S529	433	S814HB	408
C135	447	C908	466	S531	434	S822	392
C139	445	C920	457	S533	435	S823	395
C159	451	C922	463	S534	437	S902	397
C167	453	C948	467	S535	438	S903	399
C246	458	D200	485	S536	429	S904	412
C247	458	D400	492	S610	404	S922	397
C273	460	D402	493	S611	405	S933	399
C295	460	D420	492	S612	410	S944	412
C299	456	D422	493	S629	440	S991	442
C305	450	D745	486	S637	402		
C306	448	D747	488	S638	403		
C333	462	D750	491	S710	396		
C336	452	D751	491	S713	398		
C346	455	D752	490	S714	400		
C352	450	D753	490	S715	401		
C353	448	D763	485	S716	409		
C367	449	S216	411	S717	413		
C400	468	S217	413	S718	414		
C403	469	S218	414				

373 - 494



C407	466	S219	407	S739	441
C413	468	S225	417	S740	441
C428	464	S226	418	S761	415
C492	465	S227	419	S763	425
C500	470	S229	430	S765	420
C505	471	S231	431	S766	416
C700	484	S233	432	S767	428
C710	483	S260	415	S802HA	390
C800	472	S262	426	S802HB	390
C801	475	S264	421	S803HA	393
C810	473	S501	436	S803HB	393
C820	477	S511	439	S804HA	406
C822	476	S521	423	S804HB	406
C825	474	S523	424	S812HA	391
C830	481	S524	422	S812HB	391

Materiál	Материал	Materiał	Materiál
Použití	Применение	Zastosowanie	Použitie
Typ	Тип	Typ	Typ
Zuby (z)	Кол-во зубьев	Ilość ostrzy	Zuby (z)
Hĺoubka řezu	Глубина обработки	Długość	Hĺbka rezu
Úhel šroubovice/ úhel čela	Угол подъёма винтовой канавки	Kąt spirali/ Kąt natarcia	Uhol skrutkovice/ Uhol čela
Stopka	Хвостовик	Chwył	Stopka
Povlak	Покрытие	Pokrycie	Povlak
Tolerance	Допуск	Tolerancja	Tolerancia
Směr otáčení	Направление	Kierunek	Smer
Standard	Стандарт	Standard	Norma, prevedenie
■ vynikající	Основное применение	Najlepsze zastosowanie	Vynikajúce
● dobrý	Возможное применение	Dobre zastosowanie	Dobré
Příklad 10 = řezná rychlost (m/min) +/- 10%	Пример: 10 = Скорость резания в м/мин +/- 10%	Przykład 10 = prędkość skrawania w m/min +/- 10%	Príklad 10 = rezná rýchlosť (m/min) +/- 10%
Kód	Код	Kod	Kód
Rozměrová řada	Ассортимент	Zakres	Rozsah rozmerov

AMG	Česky	Русский	Polski	Slovensky
1.1	magneticky měkká	Автоматная сталь	magnetyczna miękka	Magneticky mäkká oceľ
1.2	konstrukční uhlíkatá	Низкоуглеродистая сталь	konstrukcyjna do nawęglania	Konstruktčná oceľ, uhlíková
1.3	uhlíkatá	Углеродистая нелегированная сталь	węglowa	Uhlíková oceľ
1.4	legovaná	Легированная сталь	stopowa	Legovaná oceľ
1.5	legovaná, tvrzená a temperovaná	Легированная сталь после отжига	stopowa-hartowana i odpuszczana	Legovaná oceľ, tvrdená a temperovaná
1.6	legovaná, tvrzená a temperovaná	Высоколегированная сталь после отжига	stopowa-hartowana i odpuszczana	Legovaná oceľ, tvrdená a temperovaná
1.7	legovaná, tvrzená	Легированная закаленная сталь	stopowa-hartowana	Legovaná oceľ tvrdená
1.8	legovaná, tvrzená	Легированная закаленная сталь	stopowa-hartowana	Legovaná oceľ tvrdená, oceľ odolná oproti opotrebovaniu
2.1	automatová	Ферритная нержавеющая сталь	automatowa	Automatová nehrdzavejúca oceľ
2.2	austenická	Аустенитная нержавеющая сталь	austenitczna	Austenická
2.3	feritická+austenická	Ферритно-аустенитная нержавеющая сталь	ferrytyczna+austenitczna	Feriticko austenická nehr. oceľ (Duplex)
2.4	precipitačně tvrzená	Сталь дисперсионного твердения	Utwardzane wydzieleniowo	Tvrdená nehr. oceľ
3.1	lamelární	Серый чугун	szare	Sivá liatina
3.2	lamelární	Ковкий чугун	szare	Sivá liatina
3.3	nodulární	Высокопрочный чугун	sferoidalne ciągliwe	Tvárna liatina
3.4	nodulární	Высокопрочный чугун	sferoidalne ciągliwe	Tvárna liatina
4.1	čistý	Технически чистый титан	niestopowy	Čistý titán
4.2	slitiny	Титановые сплавы	stopy tytanu	Zliatiny titánu
4.3	slitiny	Титановые сплавы	stopy tytanu	Zliatiny titánu
5.1	čistý	Технически чистый никель	niestopowy	Čistý nikel
5.2	slitiny	Никелевые сплавы	stopy niklu	Zliatiny niklu
5.3	slitiny	Никелевые сплавы	stopy niklu	Zliatiny niklu
6.1	bronz	Технически чистая медь	niestopowa	Bronz
6.2	β - mosaz, bronz	Бронза	Mosiądz-β, brąz	β - mosadz, bronz
6.3	bronz mosaz	Латунь	Mosiądz CuZn	Mosadz, bronz
6.4	bronz vysokopevnostní	Высокопрочная бронза	Brąz o wysokiej wytrzymałości	Vysokopevnostný bronz
7.1	Al, Mg, tvářené	Технически чистый алюминий/магний	Al, Mg, niestopowe	Al, Mg, tvárnený (čistý)
7.2	Al slitiny, Si<0.5%	Сплавы Al с содержанием Si<0.5%	Al. Stopowe, Si<0,5%	Al zliatiny, Si<0,5%
7.3	Al slitiny, Si>0.5%<10%	Сплавы Al с содержанием 0.5%<Si<10%	Al. Stopowe, Si>0,5%<10%	Al zliatiny, Si>0,5%<10%
7.4	Al slitiny, Si>10%	Сплавы Al с содержанием Si>10%	Al. Stopowe, Si>10%	Al zliatiny, Si>10%
8.1	termoplasty	Термопластики	Tworzywa termoplastyczne	Termoplasty
8.2	termosety	Термоактивные полимеры	Tworzywa termoutwardzalne	Termosety
8.3	zpevněné plasty	Армированные полимеры	Zbrojone tworzywa sztuczne	Spevnené plasty
9.1	cermet (keramika)	Металлокерамика	Cermetale	Cermet (kov-keramika)
10.1	standardní grafit	Технический графит	Grafit standartowy	Grafit

	HM	HM	HM	HM	HM	HM	HM	HM	HM	HM	HM	HM	HM	HM	HM		
	N	N	N	N	N	N	N	N	N	N	N	N	N	N	N		
	Z ₂	Z ₂	Z ₂	Z ₂	Z ₂	Z ₃	Z ₃	Z ₃	Z ₃	Z ₂	Z ₂	Z ₂	Z ₃	Z ₃	Z ₃		
	λ 28° γ 9°	λ 28° γ 9°	λ 28° γ 9°	λ 28° γ 9°	λ 28° γ 9°	λ 28° γ 9°	λ 28° γ 9°	λ 28° γ 9°	λ 28° γ 9°	λ 28° γ 9°	λ 40° γ 10°	λ 30° γ 12°	λ 30° γ 12°	λ 40° γ 10°	λ 30° γ 12°		
	DIN 6535HA	DIN 6535HB	DIN 6535HA	DIN 6535HB	DIN 6535HA	DIN 6535HB	DIN 6535HA	DIN 6535HB	DIN 6535HA	DIN 6535HB	DIN 6535HA	DIN 6535HB	DIN 6535HA	DIN 6535HB	DIN 6535HA		
	Alcrona	Alcrona	Alcrona	Alcrona	Alcrona	Alcrona	Alcrona	Alcrona	Alcrona	Alcrona	AlCrN	TiAlN	AlCrN	TiAlN	TiAlN		
											h9	h10	h10	h9	h10		
	DIN 6527K	DIN 6527K	DIN 6527L	DIN 6527L	DIN 6527L	DIN 6527K	DIN 6527K	DIN 6527L	DIN 6527L	DIN 6527L	DORMER	DORMER	DORMER	DORMER	DORMER		
	S802HA	S802HB	S812HA	S812HB	S822	S803HA	S803HB	S813HA	S813HB	S823	S710	S902	S922	S713	S903	S933	
	1.00 - 20.00	1.80 - 20.00	2.00 - 20.00	2.00 - 20.00	2.00 - 20.00	1.00 - 20.00	1.80 - 20.00	2.00 - 20.00	2.00 - 20.00	2.00 - 20.00	1.00 - 20.00	2.00 - 20.00	2.00 - 20.00	1.50 - 20.00	2.00 - 20.00	2.00 - 20.00	
AMG	390	390	391	391	392	393	393	394	394	395	396	397	397	398	399	399	ISO
1.1	■260B	■260B	■210B	■210B	■180B	■260B	■260B	■210B	■210B	■180B	■140C	■65B	■95B	■140C	■65B	■95B	P 1
1.2	■260B	■260B	■210B	■210B	■180B	■260B	■260B	■210B	■210B	■180B	■140C	■65B	■95B	■140C	■65B	■95B	P 1
1.3	■155B	■155B	■125B	■125B	■110B	■155B	■155B	■125B	■125B	■110B	■130C	■55B	■80B	■130C	■55B	■80B	P 2
1.4	■155B	■155B	■125B	■125B	■110B	■155B	■155B	■125B	■125B	■110B	■130C	■50B	■75B	■130C	■50B	■75B	P 3
1.5	■115B	■115B	■90B	■90B	■80B	■115B	■115B	■90B	■90B	■80B	■120C	■30B	■45B	■120C	■30B	■45B	P 4
1.6	■90B	■90B	■75B	■75B	■65B	■90B	■90B	■75B	■75B	■65B			■30B			■30B	H 1
1.7																	H 3
1.8																	H 4
2.1	■105A	■105A	■75A	■75A	■70A	■105A	■105A	■85A	■85A	■70A	■80B			■80B			M 1
2.2	■70A	■70A	■55A	■55A	■50A	■70A	■70A	■55A	■55A	■50A	■70B			■70B			M 3
2.3	■70A	■70A	■55A	■55A	■50A	■70A	■70A	■55A	■55A	■50A							M 2
2.4	●50A	●50A				●50A	●50A										S 2
3.1	■180B	■180B	■145B	■145B	■125B	■180B	■180B	■145B	■145B	■125B	■170C	■55B	■80B	■170C	■55B	■80B	K 1
3.2	■110B	■110B	■85B	■85B	■75B	■110B	■110B	■85B	■85B	■75B	■150C	●30B	■45B	■150C	●30B	■45B	K 2
3.3	■145B	■145B	■115B	■115B	■100B	■145B	■145B	■115B	■115B	■100B	■130C	■55B	■80B	■130C	■55B	■80B	K 3
3.4	■95B	■95B	■75B	■75B	■65B	■95B	■95B	■75B	■75B	■65B	■120C	●30B	■45B	■120C	●30B	■45B	K 4
4.1	●170B	●170B	■140B	■140B	■120B	●170B	●170B	●140B	●140B	●120B		■65B	■95B		■65B	■95B	S 1
4.2	●115B	●115B	■90B	■90B	■80B	●115B	●115B	●90B	●90B	●80B	■70B	●30B	●45B	■70B	●30B	●45B	S 2
4.3												●15B	●20B		●15B	●20B	S 3
5.1	●165B	●165B	■130B	■130B	■115B	●165B	●165B	●130B	●130B	●115B		■65B	■95B		■65B	■95B	S 1
5.2	●35A	●35A	■25A	■25A	■25A	●35A	●35A	●25A	●25A	●25A	■70B			■70B			S 2
5.3																	S 3
6.1	●320C	●320C	■255C	■255C	■220C	●320C	●320C	●255C	●255C	●220C		■110C	■155C		■110C	■155C	N 3
6.2	●320C	●320C	■255C	■255C	■220C	●320C	●320C	●255C	●255C	●220C		■110C	■155C		■110C	■155C	N 4
6.3	●320C	●320C	■255C	■255C	■220C	●320C	●320C	●255C	●255C	●220C		■110C	■155C		■110C	■155C	N 3
6.4	■40B	■40B	■30C	■30C	■25B	■40B	■40B	■30C	■30C	■25B		●15B	●20B		●15B	●20B	N 4
7.1	●800C	●800C	■640C	■640C	■550C	●800C	●800C	●640C	●640C	●550C		●275C	●390C		●275C	●390C	N 1
7.2	●800C	●800C	■640C	■640C	■550C	●800C	●800C	●640C	●640C	●550C		●275C	●390C		●275C	●390C	N 1
7.3	■480C	■480C	■380C	■380C	■330C	■480C	■480C	■380C	■380C	■330C		●165C	●235C		●165C	●235C	N 1
7.4	■240B	■240B	■190B	■190B	■160B	■240B	■240B	■190B	■190B	■160B							N 2
8.1	●320C	●320C	■255C	■255C	■245C	●320C	●320C	●255C	●255C	●245C		●110C	●155C		●110C	●155C	O
8.2	●320C	●320C	■255C	■255C	■245C	●320C	●320C	●255C	●255C	●245C		●110C	●155C		●110C	●155C	O
8.3												●30B	●45B		●30B	●45B	O
9.1																	H
10.1																	O

	HM	HM	HM	HM	HM	HM	HM	HM	HM	HM	HM	HM	HM	HM	HM	
	N	N	W	W	W	W	N	N	N	N	N	N	N	N	N	
	Z ₃	Z ₃	Z ₁	Z ₂	Z ₂	Z ₂	Z ₄	Z ₄	Z ₄	Z ₄	Z ₄	Z ₄	Z ₄	Z ₄	Z ₄	
	λ40° γ10°	λ40° γ10°	λ25° γ20°	λ30° γ20°	λ30° γ20°	λ30° γ20°	λ34° γ9°	λ34° γ9°	λ40° γ3°	λ34° γ9°	λ34° γ9°	λ40° γ10°	λ40° γ10°	λ40° γ3°	λ30° γ12°	
	DIN 6535HA	DIN 6535HA	DIN 6535HA	DIN 6535HA	DIN 6535HA	DIN 6535HA	DIN 6535HA	DIN 6535HA	DIN 6535HA	DIN 6535HA	DIN 6535HB	DIN 6535HA	DIN 6535HA	DIN 6535HA	DIN 6535HB	
	AlCrN	AlCrN	Hi	Hi	Hi	Hi	Alcrona	Alcrona	AlTiN	Alcrona	Alcrona	AlCrN	Diamond	AlTiN	TiAlN	
	h9	h9	h9	h9	h9	h9	h10	h10	h9	h10	h10	h9	h9	h9	h12	
							DIN 6527K	DIN 6527K		DIN 6527L	DIN 6527L					
	S714	S715	S637	S638	S610	S611	S804HA	S804HB	S219	S814HA	S814HB	S716	S612	S216	S904	
	3.00 - 20.00	3.00 - 20.00	2.00 - 12.00	6.20 - 20.30	3.00 - 20.00	6.00 - 20.00	2.00 - 25.00	2.00 - 25.00	3.00 - 20.00	2.00 - 25.00	2.00 - 25.00	2.00 - 20.00	1.00 - 12.00	2.00 - 20.00	2.00 - 20.00	
AMG	400	401	402	403	404	405	406	406	407	408	408	409	410	411	412	412
1.1	■110C	■70C					■360B	■360B		■270B	■270B	■140C			■95B	■140B
1.2	■110C	■70C					■300B	■300B		■225B	■225B	■140C			■95B	■140B
1.3	■100C	■65C					■230B	■230B		■175B	■175B	■130C			■80B	■120B
1.4	■100C	■65C					■230B	■230B		■175B	■175B	■130C			■70B	■105B
1.5	■95C	■60C					■165B	■165B		■125B	■125B	■120C			■55B	■80B
1.6							■130B	■130B	■90C	●100B	●100B		■90C		●30B	●45B
1.7																
1.8																
2.1	■65B	■40B					■165A	■165A		■125A	■125A	■80B				
2.2	■55B	■35B					■110A	■110A		●85A	●85A	■70B				
2.3							■110A	●110A	■70B	●85A	●85A			■70B		
2.4							●75A	●75A	■50B					■50B		
3.1	■135C	■85C					■275B	■275B		■205B	■205B	■170C			■80B	■120B
3.2	■120C	■75C					■165B	■165B		■125B	■125B	■150C			●55B	■80B
3.3	■100C	■65C					■165B	■165B		■125B	■125B	■130C			■70B	■105B
3.4	■95C	■60C					■135B	■135B		■105B	■105B	■120C			●55B	■80B
4.1							●275B	●275B		●205B	●205B				■95B	■140B
4.2	■55B	■35B					●140B	●140B		●105B	●105B	■70B			●40B	●60B
4.3									■50B					■50B	●30B	●45B
5.1							●275B	●275B		●205B	●205B				■135B	■200B
5.2	■55B	■35B					●55A	●55A		●40A	●40A	■70B			●30A	●45A
5.3									■50B					■50B	●25A	●35A
6.1	●200E	●125E	■350E	■400E	■350E	■280E	●320C	●320C		●255C	●255C				■110C	■155C
6.2	●190E	●115E	■300E	■345E	■300E	■240E	■320C	■320C		■255C	■255C				■110C	■155C
6.3	●175E	●110E	■250E	■290E	■250E	■200E	■320C	■320C		■255C	■255C				■110C	■155C
6.4	●160E	●100E	■200E	■230E	■200E	■160E	■40B	■40B		■32C	■32C				●15B	●20B
7.1	●200E	●125E	■600E	■690E	■600E	■480E	●800C	●800C		●640C	●640C				●275C	●390C
7.2	●190E	●115E	■500E	■575E	■500E	■400E	●800C	●800C		●640C	●640C				●275C	●390C
7.3	●175E	●110E	■400E	■460E	■400E	■320E	●480C	●480C		●380C	●380C				●165C	●235C
7.4	●160E	●100E	■350E	■400E	■350E	■280E	●240B	●240B		●190B	●190B					
8.1			■800E	■980E	■800E	■640E	●320C	●320C		●255C	●255C				●110C	●155C
8.2			■800E	■980E	■800E	■640E	●320C	●320C		●255C	●255C				●110C	●155C
8.3															●55B	●80B
9.1																
10.1															■350A	

	HM	HM	HM	HM	HM	HM	HM	HM	HM	HM	HM	HM	HM	HM	HM	HM		
	N	N	N	N	N	N	N	N	N	N	N	N	NR	NR	N	N		
	Z 4	Z 4	Z 4	Z 4	Z 4	Z 4	Z 4	Z 6-8	Z 6-8	Z 6-8	Z 6-8	Z 6-8	Z 4	Z 4	Z 4	Z 4		
	$\lambda 40^\circ$ $\gamma 10^\circ$	$\lambda 40^\circ$ $\gamma 3^\circ$	$\lambda 40^\circ$ $\gamma 10^\circ$	$\lambda 40^\circ$ $\gamma 3^\circ$	$\lambda 40^\circ$ $\gamma 10^\circ$	$\lambda 40^\circ$ $\gamma 4^\circ$	$\lambda \neq$ $\gamma 10^\circ$	$\lambda 50^\circ$ $\gamma 3^\circ$	$\lambda 50^\circ$ $\gamma 26^\circ$	$\lambda 50^\circ$ $\gamma 3^\circ$	$\lambda 50^\circ$ $\gamma 26^\circ$	$\lambda 50^\circ$ $\gamma 3^\circ$	$\lambda 50^\circ$ $\gamma 26^\circ$	$\lambda 40^\circ$ $\gamma 10^\circ$	$\lambda 40^\circ$ $\gamma 4^\circ$	$\lambda 40^\circ$ $\gamma 6^\circ$	$\lambda 45^\circ$ $\gamma 10^\circ$	
	DIN 6535HA	DIN 6535HA	DIN 6535HA	DIN 6535HA	DIN 6535HA	DIN 6535HA	DIN 6535HA	DIN 6535HA	DIN 6535HA	DIN 6535HA	DIN 6535HA	DIN 6535HA	DIN 6535HA	DIN 6535HA	DIN 6535HB	DIN 6535HA	DIN 6535HA	
	AICrN	AlTiN	AICrN	AlTiN	AICrN	AICrN	TiSiN	AlTiN	TiSiN	AlTiN	TiSiN	AlTiN	TiSiN	AICrN	AICrN	TiSiN	TiSiN	
	h9	h9	h9	h9	h9	h9	h9	h9	h9	h9	h9	h9	h9	h9	h9	h9	h9	
	DORMER	DORMER	DORMER	DORMER	DORMER	DORMER	DORMER	DORMER	DORMER	DORMER	DORMER	DORMER	DORMER	DORMER	DORMER	DORMER	DORMER	
	S717	S217	S718	S218	S761	S260	S766	S225	S525	S226	S526	S227	S527	S765	S264	S524	S521	
	3.00 - 20.00	3.00 - 20.00	3.00 - 20.00	3.00 - 20.00	3.00 - 20.00	3.00 - 20.00	4.00 - 20.00	3.00 - 20.00	3.00 - 20.00	3.00 - 20.00	3.00 - 20.00	6.00 - 20.00	3.00 - 20.00	6.00 - 20.00	6.00 - 20.00	3.00 - 16.00	3.00 - 16.00	
AMG	413	413	414	414	415	415	416	417	417	418	418	419	419	420	421	422	423	ISO
1.1	■110C		■70C		■140D		■140D		■140D					■140D				P 1
1.2	■110C		■70C		■140D		■140D		■140D					■140D				P 1
1.3	■100C		■65C		■130D		■130D		■130D					■130D				P 2
1.4	■100C		■65C		■130D		■130D		■130D					■130D				P 3
1.5	■95C		■60C		■120D		■120D		■120D					■120D				P 4
1.6		■72C		■45C		■110D		■90C		■72C		■45C			■110D			H 1
1.7					■85B			■70A		■56A		■35A		■85B	■56A	■70A		H 3
1.8								■50A		■40A		■25A			■40A	■50A		H 4
2.1	■65B		■40B		■80C		■80C							■80C				M 1
2.2	■55B		■35B		■70C		■70C							■70C				M 3
2.3		■56B		■35B		■70C		■70B		■56B		■35B			■70C			M 2
2.4		■40B		■25B		■50C		■50B		■40B		■25B			■50C			S 2
3.1	■135C		■85C		■170D		■170D							■170D				K 1
3.2	■120C		■75C		■150D		■150D							■150D				K 2
3.3	■100C		■65C		■130D		■130D							■130D				K 3
3.4	■95C		■60C		■120D		■120D							■120D				K 4
4.1																		S 1
4.2	■55B		■35B		■70C		■70C							■70C				S 2
4.3		■40B		■25B		■50C		■50B		■40B		■25B			■50C			S 3
5.1																		S 1
5.2	■55B		■35B		■70C		■70C							■70C				S 2
5.3		■40B		■25B		■50C		■50B		■40B		■25B			■50C			S 3
6.1	●200E		●125E															N 3
6.2	●190E		●115E															N 4
6.3	●175E		●110E															N 3
6.4	●160E		●100E															N 4
7.1	●200E		●125E															N 1
7.2	●190E		●115E															N 1
7.3	●175E		●110E															N 1
7.4	●160E		●100E															N 2
8.1																		O
8.2																		O
8.3																		O
9.1																		H
10.1																		O

	HM	HM	HM	HM	HM	HM	HM	HM	HM	HM	HM	HM	HM	HM	HM	HM	HM	HM	
	N	N	N	N	N	N	N	N	N	N	N	N	N	N	W	N	N		
	Z 4	Z 4	Z 4	Z 4	Z 4-6	Z 2	Z 2	Z 2	Z 2	Z 2	Z 2	Z 4	Z 4	Z 4	Z 2	Z 2	Z 2		
	$\lambda 40^\circ$ $\gamma -6^\circ$	$\lambda 40^\circ$ $\gamma 10^\circ$	$\lambda 40^\circ$ $\gamma 4^\circ$	$\lambda \neq$ $\gamma 10^\circ$	$\lambda 25^\circ$ $\gamma 0^\circ$	$\lambda 30^\circ$ $\gamma 3^\circ$	$\lambda 30^\circ$ $\gamma 3^\circ$	$\lambda 30^\circ$ $\gamma 3^\circ$	$\lambda 30^\circ$ $\gamma -10^\circ$	$\lambda 30^\circ$ $\gamma -10^\circ$	$\lambda 30^\circ$ $\gamma 10^\circ$	$\lambda 30^\circ$ $\gamma -10^\circ$	$\lambda 30^\circ$ $\gamma -10^\circ$	$\lambda 30^\circ$ $\gamma 10^\circ$	$\lambda 30^\circ$ $\gamma 15^\circ$	$\lambda 40^\circ$ $\gamma 10^\circ$	$\lambda 40^\circ$ $\gamma 10^\circ$		
	DIN 6535HA	DIN 6535HA	DIN 6535HA	DIN 6535HA	DIN 6535HA	DIN 6535HA	DIN 6535HA	DIN 6535HA	DIN 6535HA	DIN 6535HA	DIN 6535HA	DIN 6535HA	DIN 6535HA	DIN 6535HA	DIN 6535HA	DIN 6535HA	DIN 6535HA		
	TiSiN	AlCrN	AlCrN	TiSiN	TiSiN	TiSiN	TiSiN	TiSiN	TiSiN	TiSiN	X-CEED	TiSiN	TiSiN	X-CEED	Hi	AlTiN	AlTiN		
	h9	h9	h9	h9	h9	h9	h9	h9	h9	h9	h9	h9	h9	h9	h9	h9	h9		
	DORMER	DORMER	DORMER	DORMER	DORMER	DORMER	DORMER	DORMER	DORMER	DORMER	DORMER	DORMER	DORMER	DORMER	DORMER	DORMER	DORMER		
	S523	S763	S262	S767	S536	S229	S231	S233	S529	S531	S533	S501	S534	S535	S511	S629	S739	S740	
	1.50 - 16.00	3.00 - 20.00	3.00 - 20.00	4.00 - 20.00	6.00 - 12.00	1.50 - 16.00	1.50 - 16.00	2.00 - 16.00	1.50 - 16.00	1.50 - 16.00	2.00 - 16.00	1.00 - 16.00	3.00 - 16.00	3.00 - 16.00	3.00 - 16.00	3.00 - 20.00	3.00 - 20.00	3.00 - 20.00	
AMG	424	425	426	428	429	430	431	432	433	434	435	436	437	438	439	440	441	441	ISO
1.1		■140D		■140D								■181B			■230B		■140C	■140C	P 1
1.2		■140D		■140D								■181B			■192B		■140C	■140C	P 1
1.3		■130D		■130D								■118B			■153B		■130C	■130C	P 2
1.4		■130D		■130D								■118B			■153B		■130C	■130C	P 3
1.5		■120D		■120D								■90B			■115B		■120C	■120C	P 4
1.6			■110D			■630C	■500C	■315C				■72B			■92B				H 1
1.7	■70A		■85B		■105E				■330A	■260A	■165A	●45A	■330A	■260A	●61A				H 3
1.8	■50A				■75E				■280A	■225A	■140A		■280A	■225A					H 4
2.1		■80C		■80C								■81A			■115A		■80B	■80B	M 1
2.2		■70C		■70C								■54A			■76A		■70B	■70B	M 3
2.3			■70C			■540B	■430B	■270B				■54A			■76A				M 2
2.4			■50C			■315B	■250B	■155B											S 2
3.1		■170D		■170D								■136B			■192B		■170C	■170C	K 1
3.2		■150D		■150D								■81B			■115B		■155C	■155C	K 2
3.3		■130D		■130D								■109B			■115B		■145C	■145C	K 3
3.4		■120D		■120D								■72B			■96B		■130C	■130C	K 4
4.1												■136B			■192B				S 1
4.2		■70C		■70C								■90B			■96B		■70B	■70B	S 2
4.3			■50C			■315B	■250B	■155B				■45B			■61B				S 3
5.1												■136B			■192B				S 1
5.2		■70C		■70C								■27A			■38A		■70B	■70B	S 2
5.3			■50C			■315B	■250B	■155B				■22A			■30A				S 3
6.1												■363C			●384C	■350E	■250E	■250E	N 3
6.2												■363C			●384C	■300E	■235E	■235E	N 4
6.3												■363C			●384C	■250E	■220E	■220E	N 3
6.4												■54B			●61B	■200E	■200E	■200E	N 4
7.1												■950C			●950C	■600E	■250E	■250E	N 1
7.2												■950C			●950C	■500E	■235E	■235E	N 1
7.3												■681C			■576C	■400E	■220E	■220E	N 1
7.4												■363B			■307B	■350E	■200E	■200E	N 2
8.1												■318C			●307C	■800E			O
8.2												■318C			■307C	■800E			O
8.3												■318B			■307B				O
9.1												■5A			■9A				H
10.1																			O

		HSS-E PM	HSS-E PM	HSS-E PM	HSS-E PM	HSS-E	HSS-E PM	HSS-E PM	HSS-E PM	HSS-E PM	HSS-E PM	HSS-E	HSS-E PM	HSS-E		
		N	N	N	N	N	N	N	N	N	N	N	W	W	N	
		Z 2	Z 2	Z 2	Z 2	Z 2	Z 3	Z 3	Z 3	Z 3	Z 3	Z 3	Z 2	Z 3	Z 2	
		$\lambda 30^\circ$ $\gamma 12^\circ$	$\lambda 30^\circ$ $\gamma 12^\circ$	$\lambda 30^\circ$ $\gamma 12^\circ$	$\lambda 30^\circ$ $\gamma 12^\circ$	$\lambda 30^\circ$ $\gamma 12^\circ$	$\lambda 30^\circ$ $\gamma 12^\circ$	$\lambda 30^\circ$ $\gamma 12^\circ$	$\lambda 40^\circ$ $\gamma 15^\circ$	$\lambda 30^\circ$ $\gamma 12^\circ$	$\lambda 30^\circ$ $\gamma 12^\circ$	$\lambda 40^\circ$ $\gamma 20^\circ$	$\lambda 40^\circ$ $\gamma 25^\circ$	$\lambda 30^\circ$ $\gamma 12^\circ$		
		DIN 1835B	DIN 1835B	DIN 1835B	DIN 1835B	DIN 1835B	DIN 1835B	DIN 1835B	DIN 1835B	DIN 1835B	DIN 1835B	DIN 1835B	DIN 1835B	DIN 1835B	DIN 1835A	
		e8	e8	e8	e8	e8	e8 h10	e8 h10	e8	e8	e8	e8	e8	k10	js14	
		DIN 327D	DIN 327D	DIN 844K	DIN 844K	DORMER	DIN 327D	DIN 327D	DIN 327D	DIN 844K	DIN 844K	DIN 844K	DIN 844K	DIN 844K	DORMER	
		S991	C110	C126	C123	C139	C135	C306	C353	C367	C305	C352	C159	C336	C167	
		Set	1.00 - 40.00	1.00 - 30.00	1/16 - 30.00	2.00 - 25.00	2.00 - 20.00	3.00 - 30.00	3.00 - 30.00	2.00 - 20.00	2.00 - 32.00	3.00 - 20.00	2.00 - 20.00	10.00 - 30.00	6.00 - 16.00	
AMG		442	443	443	445	445	447	448	448	449	450	450	451	452	453	ISO
1.1			■60A	■135A	■55A	■120A	■50A	●53A	●145A	■146A	●56A	■135A	■50A	●55A	■50A	P 1
1.2			■50A	■105A	■45A	■95A	■40A	■49A	■120A	■117A	■44A	■105A	●40A	●44A	■40A	P 1
1.3			●40B	■95B	■40B	■85B	●35B	■41B	■100B	■102B	■39B	■95B	●35B	●38B	●35B	P 2
1.4			●35B	■80B	■35B	■70B	●30B	●35B	■85B	●87B	●33B	■80B			●30B	P 3
1.5				●55C		●50C			■60C			■55C				P 4
1.6				●25C		●20C			●25C			●25C				H 1
1.7																H 3
1.8																H 4
2.1			●30F	●45F	●25F	●45F	●25F	●26F	●50F	■67F	●26F	●50F	●23F	●25F	●25F	M 1
2.2									●45F	■55F		●40F	●19F	●21F		M 3
2.3				●25F		●25F			●30F	■35F		●25F				M 2
2.4										■25F						S 2
3.1			●35A	■60A	●30A	■55A	●30A	●32A	■65A		●30A	■60A			●30A	K 1
3.2			●30A	■50A	●25A	■45A	●25A	●27A	■55A		●25A	■50A			●25A	K 2
3.3			●50B	■90B	●45B	■80B	●40B	●48B	■95B		●45B	■90B			●40B	K 3
3.4			●30B	■55B	●30B	■50B	●25B	●30B	■60B		●27B	■55B			●25B	K 4
4.1			■35D	■45D	■30D	■45D	●30D	■33D	■50D	●50D	■29D	■45D	●28D	●30D	●30D	S 1
4.2			●25D	■40D	●25D	■35D	●25D	●26D	■40D		●24D	■35D			●25D	S 2
4.3				●15D		●15D			●20D			●15D				S 3
5.1			■60D	■130D	■50D	■115D	■50D	■58D	■140D	●140D	■51D	■125D	●48D	●52D	■50D	S 1
5.2			●15C	■25C	●15C	■25C	●15C	●15C	■30C		■13C	■25C			●15C	S 2
5.3				●10D		●10D		●15D				●10D				S 3
6.1			■85C	■190C	■80C	■170C	■70C	■110C	■210C	■209C	■100C	■190C	■100C	■100C	■75C	N 3
6.2			■85C	■190C	■80C	■170C	■70C	■110C	■210C	■209C	■100C	■190C	■100C	■100C	■75C	N 4
6.3			■85C	■190C	■80C	■170C	■70C	■110C	■210C	■209C	■100C	■190C	■100C	■100C	■75C	N 3
6.4				●25C		●25C		●30C				●25C				N 4
7.1			●220E	●480E	●200E	●435E	●180E			■528E			■250E	■250E	●200E	N 1
7.2			●220E	●480E	●200E	●435E	●180E	●219E	●530E	■528E	●198E	●480E	■250E	■250E	●200E	N 1
7.3			●85E	●190E	●80E	●170E	●70E	●86E	●210E	●209E	●79E	●190E	■100E	■100E	●75E	N 1
7.4				●95A		●85A			●105A			●95A				N 2
8.1			●90C	●190C	●80C	●175C	●70C	●72C	●210C	●209C	●65C	●190C	■100C	■100E	●80C	O
8.2													■100C	■100E		O
8.3																O
9.1																H
10.1																O

	HSS-E	HSS-E	HSS-E PM	HSS-E PM	HSS-E PM	HSS-E PM	HSS-E PM	HSS-E PM	HSS-E PM	HSS-E PM	HSS-E PM	HSS-E PM	HSS-E PM	
	N	N	N	N	N	N	N	N	N	W	HRA	HRA	HRA	
	Z 2	Z 3	Z 3-5	Z 3-6	Z 3-5	Z 4-8	Z 4-6	Z 4-6	Z 4-6	Z 3	Z 3-4	Z 4-6	Z 3-6	
	$\lambda 30^\circ$ $\gamma 12^\circ$	$\lambda 30^\circ$ $\gamma 12^\circ$	$\lambda 45^\circ$ $\gamma 12^\circ$	$\lambda 45^\circ$ $\gamma 12^\circ$	$\lambda 45^\circ$ $\gamma 12^\circ$	$\lambda 30^\circ$ $\gamma 12^\circ$	$\lambda 30^\circ$ $\gamma 12^\circ$	$\lambda 30^\circ$ $\gamma 12^\circ$	$\lambda 30^\circ$ $\gamma 12^\circ$	$\lambda 40^\circ$ $\gamma 25^\circ$	$\lambda 35^\circ$ $\gamma 12^\circ$	$\lambda 35^\circ$ $\gamma 12^\circ$	$\lambda 35^\circ$ $\gamma 12^\circ$	
	DIN 1835A	DIN 1835B	DIN 1835B	DIN 1835B	DIN 1835B	DIN 1835B	DIN 1835B	DIN 1835B	DIN 1835B	DIN 1835B	DIN 1835B	DIN 1835B	DIN 1835B	
				Alcrona	Alcrona		TiCN		TiCN		Alcrona	Alcrona	Alcrona	
	e8	e8	k10	k10	k10	k10	k10	k10	k10	k10	k12	k12	k12	
	DORMER	DIN 844L	DIN 844K	DIN 844K	DIN 844L	DIN 844K	DIN 844K	DIN 844L	DIN 844L	DIN 844L	DIN 844K	DIN 844K	DIN 844L	
	C122	C346	C299	C907	C920	C247	C246	C273	C295	C333	C922	C428	C492	
	5.00 - 22.00	3.00 - 20.00	3.00 - 20.00	3.00 - 32.00	6.00 - 25.00	2.00 - 50.00	2.00 - 25.00	2.00 - 40.00	2.00 - 40.00	10.00 - 30.00	6.00 - 32.00	6.00 - 40.00	6.00 - 30.00	
AMG	454	455	456	456	457	458	458	460	460	462	463	464	465	ISO
1.1	■45A	●45A				■55S	■120S	■50S	■110S					P 1
1.2	■36A	■35A				■45S	■95S	■50S	■85S					P 1
1.3	●31B	●30B	■37T	■95T	■85T	■40T	■85T	■35T	■75T		●95H	●93H	■83H	P 2
1.4	●27B	●25B	■33T	■80T	■70T	●35T	■70T	■30T	■65T		■80H	■79H	■71H	P 3
1.5			■22U	■55U	■50U		●50U		●45U		■55I	■54I	■49I	P 4
1.6			●10U	■25U	■20U		●20U				■25I	■24I	■21I	H 1
1.7														H 3
1.8														H 4
2.1	●20F	●20F	■26Y	■50Y	■45Y	●25Y	●45Y	●10Y	●40Y		■50L	■48L	■43L	M 1
2.2			●21Y	■40Y	■35Y						■40L	■40L	■36L	M 3
2.3			■13Y	■25Y	■25Y		●25Y		●20Y		■25L	■26L	■23L	M 2
2.4														S 2
3.1	●25A	●25A	■30S	■60S	■55S	●30S	■55S	●25S	■50S		■60G	■61G	■55G	K 1
3.2	●20A	●20A	■25S	■50S	■45S	●25S	■45S	●20S	■40S		■50G	■50G	■45G	K 2
3.3	●36B	●35B	■45T	■90T	■80T	●45T	■79T	●40T	■70T		■90H	■88H	■79H	K 3
3.4	●22B	●20B	■27T	■55T	■50T	●25T	■49T	●25T	■45T		■55H	■55H	■49H	K 4
4.1	●25D	■25D	■29V	■45V	●40V	■30V	■43V	■25V	■40V		●45J	●46J	●41J	S 1
4.2	●20D	●20D	■57V	■85V	■35V	●25V	■35V	●20V	■30V		■35J	■37J	■34J	S 2
4.3			■10V	■15V	■15V		●15V		●15V		■15J	■16J	■15J	S 3
5.1	■43D	■45D	■51V	■125V	■115V	■50V	■116V	■45V	■105V		●125J	●127J	●114J	S 1
5.2	●11C	●10C	■13U	■25U	■25U	●15U	■24U	●10U	■20U		■25I	■27I	■24I	S 2
5.3			■5V	■10V	■10V		●10V		●10V		■10J	■11J	■10J	S 3
6.1	■112C	■70C				■80U	■170U	■70U	■155U	■90C				N 3
6.2	■112C	■70C	■100U	■190U	■170U	■80U	■170U	■70U	■155U	■90C	■190I	■190I	■170I	N 4
6.3	■112C	■70C				■80U	■170U	■70U	■155U	■90C				N 3
6.4							●25U		●20U		●25I	●25I	●23I	N 4
7.1	●270E	●180E				●200X	●435X	●180X	●390X	■225E				N 1
7.2	●270E	●180E				●200X	●435X	●180X	●390X	■225E				N 1
7.3	●81E					●80X	●170X	●70X	●155X	■90E				N 1
7.4			■39S	■95S	■85S		●85S		●75S		■95G	■95G	■85G	N 2
8.1	●112C	●70C				●80U	●175U	●70U	●155U	■90E				O
8.2										■90E				O
8.3														O
9.1														H
10.1														O

	HSS-E PM	HSS-E PM	HSS-E PM	HSS-E	HSS-E	HSS-E	HSS-E	HSS-E	HSS-E	HSS	HSS-E	
	Z 4-6	Z 4-6	Z 4-6	Z 4-6	Z 4-6	Z 4-6	Z 2	Z 2	Z 6-8	Z 6-8	Z 8-12	
	DIN 1835B	DIN 1835B	DIN 1835B	DIN 1835B	DIN 1835B	DIN 1835B	DIN 1835B	DIN 1835B	DIN 1835 B	DIN 1835D	DIN 1835B	
		Alcrona	Alcrona		TICN							
	k12	k12	k12	k12	k12	k12	e8	e8	d11	d11	js16	
	C407	C908	C948	C400	C413	C403	C500	C505	C800	C810	C825	
	6.00 - 20.00	6.00 - 32.00	6.00 - 32.00	6.00 - 20.00	6.00 - 20.00	10.00 - 50.00	2.00 - 25.00	3.00 - 30.00	11.00 - 50.00	12.50 - 40.00	40.00 - 63.00	
AMG	466	466	467	468	468	469	470	471	472	473	474	ISO
1.1	■55G			●50G	●100G	●45G	■55S	■50S	■35P	■25P	■35P	P 1
1.2	■44G			■40G	■80G	■35G	■45S	■40S	■35P	■25P	■30P	P 1
1.3	■38H	■93H	■83H	■35H	■70H	■30H	●40T	●35T	■30O	■20O	■30O	P 2
1.4	■33H	■79H	■71H	●30H	■60H	●25H	●35T	●30T	■25O	■15O	■20O	P 3
1.5	■22I	■54I	■49I		●40I	■25I			■20N	●10N	■15N	P 4
1.6	●10I	●24I	■21I		●20I				■15N	●10N	■10N	H 1
1.7												H 3
1.8												H 4
2.1	■25L	■48L	■43L	●25L	●35L	●20L	●25Y	●25Y	■20M	■15M	■15M	M 1
2.2	●21L	■40L	■36L						■15M	●10M	■10M	M 3
2.3	■13L	■26L	■23L		●20L				■10M	●10M	■10M	M 2
2.4												S 2
3.1	■30G	■61G	■55G	●30G	■45G	●25G	●30S	●30S	■20P	■20P	■25P	K 1
3.2	■25G	■50G	■45G	●25G	■35G	●20G	●25S	●25S	■20P	■20P	■20P	K 2
3.3	■44H	■88H	■79H	●40H	■65H	■35H	●45T	●40T	■30O	■20O	■30O	K 3
3.4	■27H	■55H	■49H	●25H	■40H	●20H	●30T	●25T	■20O	■10O	■20O	K 4
4.1	●30J	●46J	●41J	●30J	●35J	●25J	■30V	■30V	■30P	■20P	■35P	S 1
4.2	■25J	■37J	■34J	●25J	■30J	●20J	●25V	●25V	■20P	●15P	■20P	S 2
4.3	■11J	■16J	■15J		●10J				■10O	●5O	■10O	S 3
5.1	●52J	●127J	●114J	●50J	●95J	●45J	■50V	■50V	■35P	■25P	■35P	S 1
5.2	■14I	■27I	■24I	●15I	●20I	●10I	●15U	●15U	■10O	●5O	●5O	S 2
5.3	■6J	■11J	■10J		●10J				■5N	●5N	■5N	S 3
6.1				●70I	●140I	●65I	■85U	■80U	■100Q	■50Q	■30Q	N 3
6.2	■100I	■190I	■170I	■70I	■140I	■65I	■85U	■80U	■100P	■55P	■35P	N 4
6.3				■70I	■140I	■65I	■85U	■80U	■35P	■20P	■35P	N 3
6.4	●13I	●25I	●23I		●20I				■15O	■5O	■10O	N 4
7.1							●220X	●200X	■250R	■60R	■70R	N 1
7.2				●180K	●360K	●160K	●220X	●200X	■250R	■50R	■70R	N 1
7.3				●70K	●140K	●65K	●85X	●80X	■65R	■30R	■30R	N 1
7.4	●39G	●95G	■85G		●70G				■45Q	●20Q	■20Q	N 2
8.1				●70I	●145I	●65I	●90U	●80U	■100R	●50R	■35R	O
8.2												O
8.3												O
9.1												H
10.1									■45Q	●20Q	■20Q	O

	HSS-E	HSS-E	HSS	HSS	HSS	HSS-E	HSS-E	HSS	HSS-E	HSS-E	
	Z 6-8	Z 6-12	Z 6-12	Z 6-8	Z 6-8	Z 10-12	Z 10-12	Z 4	Z 4-6	Z 16-30	
	DIN 1835B	DIN 1835 D	DIN 1835D	DIN 1835D	DIN 1835D	DIN 1835B	DIN 1835B	DIN 1835B	DIN 1835B	DIN 1835B	
	DIN 851	DIN 850	DORMER	DORMER	DORMER	DIN 1833C	DIN 1833D	BS 122/4	DORMER	DIN 885A	
	C801	C822	C820	C837	C835	C830	C831	C710	C700	D200	
	16.00 - 32.00	4.50 - 45.50	10.50 - 45.50	13.00 - 38.00	1/2 - 1.1/2	12.00 - 32.00	12.00 - 32.00	1/16 - 1/2	1.00 - 20.00	50.00 - 125.00	
AMG	475	476	477	479	480	481	482	483	484	485	ISO
1.1	■40P	■40P	■25P	■20P	■20P	■30P	■30P	■20P	■35P	■45P	P 1
1.2	■40P	■40P	■25P	■20P	■20P	■30P	■30P	■20P	■35P	■40P	P 1
1.3	■30O	■30O	■20O	■15O	■15O	■25O	■25O	■15O	■25O	■35P	P 2
1.4	■25O	■25O	■20O	■15O	■15O	■20O	■20O	■15O	■25O	■30P	P 3
1.5	■20N	■20N	●10N	●10N	●10N	■15N	■15N	●10N	■15N	■20P	P 4
1.6	■15N	■15N	●10N	●5N	●5N	■10N	■10N	●10N	■15N	■10P	H 1
1.7											H 3
1.8											H 4
2.1	■25M	■25M	■15M	■10M	■10M	■20M	■20M	■15M	■20M	■30P	M 1
2.2	■15M	■15M	■10M	●10M	●10M	■15M	■15M	■10M	■15M	■20P	M 3
2.3	■15M	■15M	●10M	●5M	●5M	■10M	■10M	●5M	■10M	■10Q	M 2
2.4											S 2
3.1	■25P	■25P	■20P	■15P	■15P	■20P	■20P	■20P	■20P	■30Q	K 1
3.2	■20P	■20P	■20P	■15P	■15P	■15P	■15P	■15P	■15P	■25Q	K 2
3.3	■35O	■30O	■20O	■15O	■15O	■25O	■25O	■15O	■25O	■40Q	K 3
3.4	■20O	■20O	■15O	■10O	■10O	■15O	■15O	■10O	■15O	■25Q	K 4
4.1	■30P	■30P	■20P	■15P	■15P	■25P	■25P	■15P	■25P	■30N	S 1
4.2	■20P	■20P	●15P	●10P	●10P	■15P	■15P	■10P	■20P	■20O	S 2
4.3	■10O	■10O	●10O	●5O	●5O	■10O	■10O	●5O	■10O	■15O	S 3
5.1	■40P	■35P	■25P	■20P	■20P	■30P	■30P	■20P	■35P	■40P	S 1
5.2	■10O	■10O	●5O	●5O	●5O	■10O	■10O	●5O	■10O	■15O	S 2
5.3	■5N	■5N	●5N	●5N	●5N	■5N	■5N	●5N	■5N	■10M	S 3
6.1	■110Q	■100Q	■50Q	■40Q	■40Q	■90Q	■90Q	■40Q	■90Q	■150P	N 3
6.2	■110P	■100P	■55P	■45P	■45P	■90P	■90P	■45P	■90P	■150P	N 4
6.3	■40P	■100P	■55P	■15P	■15P	■75P	■75P	■45P	■90P	■150P	N 3
6.4	■15O	■15O	●5O	●5O	●5O	■10O	■10O	●5O	■15O	■15M	N 4
7.1	■275R	■260R	■65R	■50R	■50R	■190R	■190R	■55R	■245R	■400Q	N 1
7.2	■275R	■260R	■50R	■40R	■40R	■190R	■190R	■40R	■230R	■400Q	N 1
7.3	■70R	■66R	■35R	■25R	■25R	■55R	■55R	■25R	■60R	■100Q	N 1
7.4	■45Q	■44Q	●20Q	●17Q	●17Q	■35Q	■35Q	●15Q	■40Q	■70Q	N 2
8.1	■110R	■100R	●50R	●40R	●40R	■75R	■75R			■150M	O
8.2											O
8.3											O
9.1											H
10.1	■45Q	■45Q	●20Q			■35Q	■35Q	●15Q	■40Q		O

	HSS-E	HSS	HSS	HSS	HSS	HSS	HSS	HSS-E	
	Z 28-44	Z 28-100	Z 40-200	Z 80-180	Z 100-140	Z 128-220	Z 160-350	Z 8-12	N
	$\lambda 15^\circ$ $\gamma 10^\circ$	$\gamma 15^\circ$	$\gamma 5^\circ$	$\gamma 18^\circ$	$\gamma 18^\circ$	$\gamma 18^\circ$	$\gamma 18^\circ$	$\lambda 30^\circ$ $\gamma 12^\circ$	
	js16			ST	ST	ST	ST	js16	
	DIN 885A	DIN 1838	DIN 1837	DORMER	DORMER	DORMER	DORMER	DIN 1880	
	D763	D745	D747	D752	D753	D750	D751	D400	
	63.00 - 125.00	50.00 - 250.00	32.00 - 200.00	250.00 - 350.00	250.00 - 350.00	200.00 - 350.00	200.00 - 350.00	40.00 - 63.00	
AMG	485	486	488	490	490	491	491	492	ISO
1.1	■45P	■40R	■40R	■40R	■40R	■40R	■40R	■40J	P 1
1.2	■40P	■30R	■30R	■30R	■30R	■30R	■30R	■40J	P 1
1.3	■35P	■30R	■30R	■30R	■30R	■30R	■30R	■30I	P 2
1.4	■30P	■20S	■20S	■20S	■20S	■20S	■20S	■25I	P 3
1.5	■20P							●20H	P 4
1.6	■10P							●15H	H 1
1.7									H 3
1.8									H 4
2.1	■30P	●10S	●10S	●10S	●10S	●10S	●10S	■25H	M 1
2.2	■20P	●10S	●10S	●10S	●10S	●10S	●10S	●15G	M 3
2.3	■10Q							■10G	M 2
2.4									S 2
3.1	■30Q	■40R	■40R	■40R	■40R	■40R	■40R	■20J	K 1
3.2	■25Q	■40R	■40R	■40R	■40R	■40R	■40R	■20J	K 2
3.3	■40Q	■30R	■30R	■30R	■30R	■30R	■30R	■30I	K 3
3.4	■25Q							■20I	K 4
4.1	■30N							■30J	S 1
4.2	■20O							●20I	S 2
4.3	■15O							●10I	S 3
5.1	■40P							■35J	S 1
5.2	■15O							●10I	S 2
5.3	■10M							●5H	S 3
6.1	■150P	■200R	■200R	■200R	■200R	■200R	■200R	■105M	N 3
6.2	■150P	■200T	■200T	■200T	■200T	■200T	■200T	■105K	N 4
6.3	■150P	■200T	■200T	■200T	■200T	■200T	■200T	■35K	N 3
6.4	■15M							●15H	N 4
7.1	■400Q	■600T	■600T	■600T	■600T	■600T	■600T	●260N	N 1
7.2	■400Q	■500T	■500T	■500T	■500T	■500T	■500T	■260N	N 1
7.3	■100Q	■500T	■500T	■500T	■500T	■500T	■500T	■65N	N 1
7.4	■70Q							●45L	N 2
8.1	■150M	■60T	■60T	■60T	■60T	■60T	■60T	●105N	O
8.2								●30N	O
8.3								●5L	O
9.1									H
10.1								●45K	O

	HSS-E	HSS-E	HSS-E
	N	NR	NR
	Z 8-12	Z 6-10	Z 6-10
	$\lambda 30^\circ$ $\gamma 12^\circ$	$\lambda 30^\circ$ $\gamma 12^\circ$	$\lambda 30^\circ$ $\gamma 12^\circ$
	js16	js16	js16
	DIN 1880	DIN 1880	DIN 1880
	D420	D402	D422
	40.00 - 63.00	40.00 - 63.00	40.00 - 63.00

AMG	492	493	493	ISO
1.1	■75J	■40J	■75J	P 1
1.2	■75J	■40J	■75J	P 1
1.3	■65I	■30I	■65I	P 2
1.4	■50I	■25I	■50I	P 3
1.5	■35H	●20H	■35H	P 4
1.6	■30H	●15H	■30H	H 1
1.7				H 3
1.8				H 4
2.1	■35H	■25H	■35H	M 1
2.2	■30G	●15G	■30G	M 3
2.3	■20G	■10G	■20G	M 2
2.4				S 2
3.1	■35J	■20J	■35J	K 1
3.2	■30J	■20J	■30J	K 2
3.3	■50I	■30I	■50I	K 3
3.4	■30I	■20I	■30I	K 4
4.1	■35J	■30J	■35J	S 1
4.2	■25I	●20I	■25I	S 2
4.3	■15I	●10I	■15I	S 3
5.1	■75J	■35J	■75J	S 1
5.2	■20I	●10I	■20I	S 2
5.3	■10H	●5H	■10H	S 3
6.1	■150M	■105M	■150M	N 3
6.2	■150K	■105K	■150K	N 4
6.3	■50K	■35K	■50K	N 3
6.4	■20H	●15H	■20H	N 4
7.1	●260N	●260N	●260N	N 1
7.2	■260N	■260N	■260N	N 1
7.3	■135N	■65N	■135N	N 1
7.4	■75L	●45L	■75L	N 2
8.1	■120N	●105N	■120N	O
8.2	●60N	●30N	●60N	O
8.3	●15L	●5L	●15L	O
9.1				H
10.1	■125K	●45K	■125K	O

HM					Ae	Ap	 fz	ϕ [mm]	fz [mm/Z] $\pm 25\%$												
Z	Z	Z	Z	Z	(x ϕ)	(x ϕ)			ϕ	1	2	3	4	5	6	8	10	12	14	16	18
					0.05	1.5															
								A	0.012	0.024	0.035	0.045	0.055	0.065	0.080	0.093	0.107	0.121	0.134	0.149	0.162
								B	0.016	0.032	0.047	0.061	0.074	0.087	0.107	0.124	0.143	0.162	0.179	0.198	0.216
								C	0.020	0.040	0.058	0.076	0.092	0.108	0.134	0.156	0.179	0.202	0.224	0.248	0.271
								D	0.024	0.048	0.070	0.091	0.111	0.130	0.160	0.187	0.214	0.242	0.268	0.297	0.325
								E	0.028	0.056	0.081	0.106	0.129	0.152	0.187	0.218	0.250	0.283	0.313	0.347	0.379
								F	0.032	0.064	0.093	0.121	0.148	0.173	0.214	0.249	0.286	0.323	0.358	0.396	0.433
								G	0.037	0.071	0.105	0.136	0.166	0.195	0.240	0.280	0.321	0.364	0.403	0.446	0.487
								H	0.041	0.079	0.116	0.152	0.185	0.216	0.267	0.311	0.357	0.404	0.447	0.495	0.541
					0.08	1.5															
								A	0.010	0.019	0.028	0.036	0.044	0.052	0.064	0.074	0.085	0.096	0.107	0.118	0.129
								B	0.013	0.025	0.037	0.048	0.059	0.069	0.085	0.099	0.114	0.128	0.142	0.157	0.172
								C	0.016	0.032	0.046	0.060	0.073	0.086	0.106	0.124	0.142	0.161	0.178	0.197	0.215
								D	0.019	0.038	0.055	0.072	0.088	0.103	0.127	0.148	0.170	0.193	0.213	0.236	0.258
								E	0.023	0.044	0.065	0.084	0.103	0.120	0.149	0.173	0.199	0.225	0.249	0.276	0.301
								F	0.026	0.050	0.074	0.096	0.118	0.138	0.170	0.198	0.227	0.257	0.284	0.315	0.344
								G	0.029	0.057	0.083	0.108	0.132	0.155	0.191	0.223	0.256	0.289	0.320	0.354	0.387
								H	0.032	0.063	0.092	0.120	0.147	0.172	0.212	0.247	0.284	0.321	0.356	0.394	0.430
					0.15	1.5															
								A	0.007	0.014	0.021	0.027	0.033	0.038	0.047	0.055	0.063	0.071	0.079	0.087	0.095
								B	0.010	0.019	0.027	0.036	0.043	0.051	0.063	0.073	0.084	0.095	0.105	0.116	0.127
								C	0.012	0.023	0.034	0.045	0.054	0.064	0.078	0.091	0.105	0.119	0.132	0.146	0.159
								D	0.014	0.028	0.041	0.053	0.065	0.076	0.094	0.110	0.126	0.143	0.158	0.175	0.191
								E	0.017	0.033	0.048	0.062	0.076	0.089	0.110	0.128	0.147	0.166	0.184	0.204	0.223
								F	0.019	0.037	0.055	0.071	0.087	0.102	0.126	0.146	0.168	0.190	0.210	0.233	0.255
								G	0.021	0.042	0.062	0.080	0.098	0.115	0.141	0.165	0.189	0.214	0.237	0.262	0.286
								H	0.024	0.047	0.068	0.089	0.109	0.127	0.157	0.183	0.210	0.238	0.263	0.291	0.318
					0.30	1.5															
								A	0.005	0.010	0.015	0.019	0.024	0.028	0.034	0.040	0.046	0.052	0.058	0.064	0.070
								B	0.007	0.014	0.020	0.026	0.032	0.037	0.046	0.053	0.061	0.069	0.077	0.085	0.093
								C	0.009	0.017	0.025	0.032	0.040	0.046	0.057	0.067	0.077	0.087	0.096	0.106	0.116
								D	0.010	0.020	0.030	0.039	0.048	0.056	0.069	0.080	0.092	0.104	0.115	0.127	0.139
								E	0.012	0.024	0.035	0.045	0.055	0.065	0.080	0.093	0.107	0.121	0.134	0.149	0.162
								F	0.014	0.027	0.040	0.052	0.063	0.074	0.092	0.107	0.122	0.138	0.153	0.170	0.185
								G	0.016	0.031	0.045	0.058	0.071	0.083	0.103	0.120	0.138	0.156	0.173	0.191	0.209
								H	0.017	0.034	0.050	0.065	0.079	0.093	0.114	0.133	0.153	0.173	0.192	0.212	0.232
					0.60	1.5															
								A	0.004	0.008	0.011	0.015	0.018	0.021	0.026	0.031	0.035	0.040	0.044	0.049	0.053
								B	0.005	0.010	0.015	0.020	0.024	0.028	0.035	0.041	0.047	0.053	0.059	0.065	0.071
								C	0.007	0.013	0.019	0.025	0.030	0.035	0.044	0.051	0.058	0.066	0.073	0.081	0.089
								D	0.008	0.016	0.023	0.030	0.036	0.043	0.052	0.061	0.070	0.079	0.088	0.097	0.106
								E	0.009	0.018	0.027	0.035	0.042	0.050	0.061	0.071	0.082	0.093	0.103	0.114	0.124
								F	0.011	0.021	0.030	0.040	0.048	0.057	0.070	0.082	0.094	0.106	0.117	0.130	0.142
								G	0.012	0.023	0.034	0.045	0.054	0.064	0.079	0.092	0.105	0.119	0.132	0.146	0.159
								H	0.013	0.026	0.038	0.050	0.061	0.071	0.087	0.102	0.117	0.132	0.146	0.162	0.177

■	Vynikajúci Основное применение Najlepsze zastosowanie Vynikajúce	●	Dobrý Возможное применение Dobre zastosowanie Dobré
---	---	---	--

HM

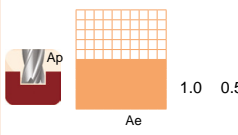
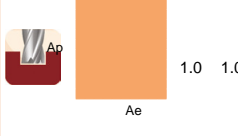
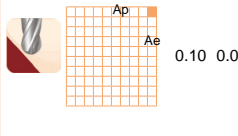
Z	Z	Z	Z	Z	A _e (x Ø)	A _p (x Ø)	 fz	Ø [mm]	fz [mm/Z] ± 25 %												
1	2	3	4	>4				Ø	1	2	3	4	5	6	8	10	12	14	16	18	20
					A	0.003	0.006	0.009	0.012	0.014	0.017	0.021	0.024	0.028	0.032	0.035	0.039	0.042			
					B	0.004	0.008	0.012	0.016	0.019	0.023	0.028	0.033	0.037	0.042	0.047	0.052	0.057			
					C	0.005	0.010	0.015	0.020	0.024	0.028	0.035	0.041	0.047	0.053	0.058	0.065	0.071			
					D	0.006	0.012	0.018	0.024	0.029	0.034	0.042	0.049	0.056	0.063	0.070	0.078	0.085			
					E	0.007	0.015	0.021	0.028	0.034	0.040	0.049	0.057	0.065	0.074	0.082	0.091	0.099			
					F	0.008	0.017	0.024	0.032	0.039	0.045	0.056	0.065	0.075	0.084	0.093	0.103	0.113			
					G	0.010	0.019	0.027	0.036	0.043	0.051	0.063	0.073	0.084	0.095	0.105	0.116	0.127			
					H	0.011	0.021	0.030	0.040	0.048	0.057	0.070	0.081	0.093	0.106	0.117	0.129	0.141			
										A	0.003	0.005	0.007	0.010	0.012	0.014	0.017	0.020	0.022	0.025	0.028
B	0.003	0.007	0.010	0.013						0.015	0.018	0.022	0.026	0.030	0.034	0.037	0.041	0.045			
C	0.004	0.008	0.012	0.016						0.019	0.023	0.028	0.033	0.037	0.042	0.047	0.052	0.057			
D	0.005	0.010	0.015	0.019						0.023	0.027	0.033	0.039	0.045	0.051	0.056	0.062	0.068			
E	0.006	0.012	0.017	0.022						0.027	0.032	0.039	0.046	0.052	0.059	0.065	0.072	0.079			
F	0.007	0.013	0.019	0.025						0.031	0.036	0.045	0.052	0.060	0.068	0.075	0.083	0.090			
G	0.008	0.015	0.022	0.029						0.035	0.041	0.050	0.059	0.067	0.076	0.084	0.093	0.102			
H	0.008	0.017	0.024	0.032						0.039	0.045	0.056	0.065	0.075	0.084	0.093	0.103	0.113			
										A	0.004	0.008	0.012	0.016	0.020	0.023	0.029	0.033	0.038	0.043	0.048
					B	0.006	0.011	0.017	0.022	0.026	0.031	0.038	0.044	0.051	0.058	0.064	0.071	0.077			
					C	0.007	0.014	0.021	0.027	0.033	0.039	0.048	0.056	0.064	0.072	0.080	0.088	0.097			
					D	0.009	0.017	0.025	0.032	0.040	0.046	0.057	0.067	0.076	0.086	0.096	0.106	0.116			
					E	0.010	0.020	0.029	0.038	0.046	0.054	0.067	0.078	0.089	0.101	0.112	0.124	0.135			
					F	0.012	0.023	0.033	0.043	0.053	0.062	0.076	0.089	0.102	0.115	0.128	0.141	0.154			
					G	0.013	0.025	0.037	0.049	0.059	0.069	0.086	0.100	0.115	0.130	0.144	0.159	0.174			
					H	0.014	0.028	0.042	0.054	0.066	0.077	0.095	0.111	0.127	0.144	0.160	0.177	0.193			

- | | | | |
|---|---|---|--|
| ■ | Vynikající
Основное применение
Najlepsze zastosowanie
Vynikajúce | ● | Dobry
Возможное применение
Dobre zastosowanie
Dobré |
|---|---|---|--|

HSS HSS-E HSS-E PM

Z 2	Z 3	Z 4	Z >4	Ø	Ae (x Ø)	Ap (x Ø)	 fz	Ø [mm] fz [mm/Z] ± 25 %																					
								Ø	1	2	3	4	5	6	8	10	12	14	16	18	20	22	25	28	30	32	36	40	50
			A	0.004	0.008	0.013	0.017	0.024	0.029	0.043	0.060	0.072	0.084	0.096	0.097	0.096	0.099	0.105	0.109	0.108	0.106	0.108	0.108	0.105					
			B	0.004	0.007	0.012	0.015	0.022	0.026	0.039	0.054	0.065	0.076	0.086	0.087	0.086	0.089	0.095	0.098	0.097	0.095	0.097	0.097	0.095	0.097	0.097	0.095		
			C	0.003	0.006	0.011	0.014	0.019	0.023	0.035	0.049	0.058	0.068	0.078	0.079	0.078	0.080	0.085	0.088	0.087	0.086	0.087	0.087	0.086	0.087	0.087	0.085	0.087	0.085
			D	0.004	0.007	0.011	0.014	0.020	0.024	0.037	0.051	0.061	0.071	0.081	0.082	0.081	0.084	0.089	0.099	0.091	0.097	0.091	0.101	0.097	0.091	0.101	0.101	0.101	
			E	0.007	0.012	0.018	0.024	0.035	0.042	0.063	0.087	0.105	0.122	0.140	0.141	0.140	0.144	0.153	0.171	0.157	0.168	0.157	0.175	0.168	0.157	0.175	0.175	0.175	
			F	0.007	0.009	0.013	0.018	0.021	0.025	0.033	0.041	0.050	0.055	0.064	0.072	0.079	0.079	0.085	0.085	0.085	0.085	0.085	0.085	0.085	0.085	0.085	0.085	0.085	0.085
			G						0.026	0.034	0.036	0.043	0.050	0.057	0.064	0.071	0.071	0.054	0.053	0.054	0.053	0.056	0.057	0.060	0.056	0.057	0.060		
			H						0.023	0.031	0.032	0.039	0.045	0.051	0.058	0.064	0.064	0.049	0.048	0.049	0.048	0.048	0.048	0.050	0.051	0.054	0.050	0.051	0.054
			I						0.021	0.028	0.029	0.035	0.041	0.046	0.052	0.058	0.058	0.044	0.043	0.044	0.043	0.043	0.043	0.045	0.046	0.049	0.045	0.046	0.049
			J						0.024	0.031	0.033	0.039	0.046	0.052	0.059	0.065	0.065	0.049	0.049	0.049	0.049	0.049	0.049	0.051	0.052	0.055	0.051	0.052	0.055
			K						0.035	0.047	0.065	0.079	0.092	0.105	0.088	0.098	0.097	0.110	0.110	0.110	0.110	0.110	0.110	0.115	0.118	0.123	0.115	0.118	0.123
			L						0.010	0.013	0.017	0.020	0.025	0.028	0.030	0.032	0.033	0.034	0.036	0.038	0.039	0.040	0.042	0.042	0.040	0.042	0.042	0.040	0.042
			M	0.008	0.012	0.018	0.023	0.031	0.041	0.057	0.069	0.080	0.091	0.103	0.114	0.090	0.103	0.085	0.091	0.097	0.110	0.107	0.086	0.110	0.107	0.086			
			N	0.007	0.011	0.016	0.021	0.028	0.037	0.051	0.062	0.072	0.082	0.093	0.103	0.081	0.093	0.077	0.082	0.087	0.099	0.096	0.077	0.099	0.096	0.077	0.099	0.096	0.077
			O	0.006	0.010	0.015	0.019	0.025	0.033	0.046	0.056	0.065	0.074	0.083	0.092	0.073	0.083	0.069	0.074	0.079	0.089	0.087	0.070	0.089	0.087	0.070	0.089	0.087	0.070
			P	0.007	0.010	0.016	0.020	0.027	0.035	0.049	0.059	0.069	0.079	0.088	0.098	0.078	0.088	0.073	0.079	0.084	0.094	0.092	0.074	0.094	0.092	0.074	0.094	0.092	0.074
			Q	0.009	0.014	0.021	0.026	0.036	0.048	0.066	0.079	0.092	0.106	0.089	0.099	0.098	0.111	0.111	0.119	0.127	0.143	0.139	0.148	0.143	0.139	0.148	0.143	0.139	0.148
			R	0.012	0.016	0.020	0.025	0.029	0.038	0.047	0.056	0.065	0.073	0.083	0.092	0.092	0.092	0.092	0.092	0.092	0.104	0.104	0.108	0.108	0.104	0.108	0.108	0.104	0.108
			S	0.010	0.015	0.023	0.029	0.039	0.051	0.071	0.086	0.100	0.114	0.129	0.143	0.113	0.129	0.107	0.114	0.122	0.137	0.133	0.107	0.137	0.133	0.107			
			T	0.009	0.014	0.021	0.026	0.035	0.046	0.064	0.077	0.090	0.103	0.116	0.129	0.102	0.116	0.096	0.103	0.110	0.123	0.120	0.096	0.123	0.120	0.096	0.123	0.120	0.096
			U	0.008	0.012	0.019	0.023	0.032	0.041	0.058	0.070	0.081	0.092	0.104	0.116	0.092	0.104	0.087	0.092	0.099	0.111	0.108	0.087	0.111	0.108	0.087	0.111	0.108	0.087
			V	0.009	0.013	0.020	0.025	0.033	0.044	0.061	0.074	0.086	0.098	0.110	0.123	0.097	0.110	0.092	0.098	0.105	0.118	0.115	0.092	0.118	0.115	0.092	0.118	0.115	0.092
			X	0.012	0.017	0.026	0.033	0.045	0.059	0.082	0.099	0.115	0.132	0.111	0.124	0.122	0.139	0.139	0.148	0.158	0.178	0.173	0.186	0.178	0.173	0.186	0.178	0.173	0.186
			Y	0.015	0.020	0.025	0.031	0.036	0.047	0.059	0.070	0.081	0.092	0.104	0.115	0.115	0.115	0.115	0.115	0.115	0.130	0.130	0.136	0.130	0.136	0.136	0.130	0.136	0.136

Vynikající
 Основное применение
 Najlepsze zastosowanie
 Vynikajúce

Dobrý
 Возможное применение
 Dobre zastosowanie
 Dobré

HSS HSS-E HSS-E PM

Ø	fz	Ø [mm] fz [mm/Z] ± 25 %															
		10	12	16	20	25	32	38	50	63	80	100	125	160	200	300	350
C800 C801 C810 C820 C822 C825		M	0.017	0.022	0.036	0.038	0.041	0.044	0.045	0.047							
	N	0.022	0.027	0.045	0.046	0.052	0.058	0.06	0.062								
	O	0.025	0.03	0.052	0.055	0.056	0.058	0.06	0.062								
	P	0.030	0.043	0.063	0.064	0.062	0.068	0.07	0.072								
	Q	0.045	0.048	0.063	0.064	0.066	0.068	0.07	0.072								
	R	0.055	0.07	0.115	0.119	0.123	0.126	0.128	0.13								

Ø	fz	Ø [mm] fz [mm/Z] ± 25 %															
		10	12	16	20	25	32	38	50	63	80	100	125	160	200	300	350
C830 C835 C837 C831		M	0.036	0.045	0.057	0.064	0.074	0.084									
	N	0.048	0.058	0.073	0.084	0.095	0.105										
	O	0.052	0.063	0.081	0.092	0.103	0.114										
	P	0.059	0.071	0.089	0.1	0.112	0.125										
	Q	0.072	0.088	0.106	0.12	0.133	0.147										
	R	0.079	0.095	0.114	0.13	0.143	0.157										



Ø	fz	Ø [mm] fz [mm/Z] ± 25 %															
		10	12	16	20	25	32	38	50	63	80	100	125	160	200	300	350
C700 C710		M	0.03	0.03	0.03	0.04	0.05	0.05									
	N	0.04	0.04	0.04	0.05	0.06	0.07										
	O	0.04	0.04	0.05	0.06	0.07	0.08										
	P	0.04	0.04	0.05	0.07	0.08	0.08										
	Q	0.05	0.05	0.07	0.08	0.09	0.10										
	R	0.06	0.06	0.07	0.09	0.10	0.11										



Ø	fz	Ø [mm] fz [mm/Z] ± 25 %															
		10	12	16	20	25	32	38	50	63	80	100	125	160	200	300	350
D745 D747 D750 D751 D752 D753		R					0.040	0.040	0.040	0.040	0.040	0.040	0.040	0.040	0.040	0.040	0.040
	S					0.020	0.020	0.020	0.020	0.020	0.020	0.020	0.020	0.020	0.020	0.020	0.020
	T					0.060	0.060	0.060	0.060	0.060	0.060	0.060	0.060	0.060	0.060	0.060	0.060

Ø	fz	Ø [mm] fz [mm/Z] ± 25 %															
		10	12	16	20	25	32	38	50	63	80	100	125	160	200	300	350
D200 D763		M						0.040	0.050	0.060	0.070	0.080	0.090	0.100			
	N							0.060	0.070	0.080	0.090	0.100	0.105	0.115			
	O							0.070	0.080	0.090	0.100	0.105	0.110	0.120			
	P							0.080	0.090	0.095	0.110	0.115	0.115	0.125			
	Q							0.090	0.100	0.105	0.110	0.115	0.125	0.135			

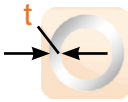
Ø	fz	Ø [mm] fz [mm/Z] ± 25 %															
		40	50	60	80	100	125										
D402 D422		G	0.042	0.049	0.040	0.047	0.040	0.037									
	H	0.050	0.059	0.047	0.055	0.048	0.044										
	I	0.062	0.071	0.058	0.066	0.058	0.054										
	J	0.082	0.095	0.078	0.090	0.078	0.073										
	K	0.118	0.140	0.110	0.130	0.110	0.103										
	L	0.145	0.171	0.136	0.160	0.136	0.127										
	M	0.185	0.160	0.170	0.200	0.170	0.160										
	N	0.270	0.320	0.250	0.290	0.250	0.230										









Ø	fz	Ø [mm] fz [mm/Z] ± 25 %															
		40	50	60	80	100											
D400 D420		G	0.042	0.049	0.040	0.047	0.040										
	H	0.050	0.059	0.047	0.055	0.048											
	I	0.062	0.071	0.058	0.066	0.058											
	J	0.082	0.095	0.078	0.090	0.078											
	K	0.118	0.140	0.110	0.130	0.110											
	L	0.145	0.171	0.136	0.160	0.136											
	M	0.185	0.160	0.170	0.200	0.170											
	N	0.270	0.320	0.250	0.290	0.250											

D750 D751 D752 D753	<p>Výběr rozteče zubů „P“ Выбор шага зубьев фрезы Dobór freza przy cięciu rurek cienkościennych i prętów Výber rozostupu zubov „P“</p>									
	 t (mm)						 Ø (mm)			
	<1.0 mm	1.0 - 1.5 mm	1.5 - 2.0 mm	2.0 - 3.0 mm	3.0 - 4.0 mm	>4.0 mm	10 - 20 mm	20 - 40 mm	40 - 60 mm	
1.1	3	4	5	5	6	7	5	8		P 1
1.2	3	4	4	5	6	7	5	6		P 1
1.3	3	4	4	5	6	7	5	6		P 2
1.4	3	4	4	5	6	7	5	6		P 3
1.5	3	3	4	5	5	6	5	6	8	P 4
1.6										H 1
1.7										H 3
1.8										H 4
2.1	3	4	5	5	6	6	5	6	8	M 1
2.2	3	4	5	5	6	6	5	6	8	M 3
2.3	3	4	5	5	6	6	5	6	8	M 2
2.4	3	4	5	5	6	6	5	6	8	S 2
3.1							6	8		K 1
3.2							6	8		K 2
3.3							6	8		K 3
3.4							6	8		K 4
4.1										S 1
4.2										S 2
4.3										S 3
5.1										S 1
5.2										S 2
5.3										S 3
6.1	4	5	6	7	8	8	6	8		N 3
6.2	4	5	6	7	8	8	8			N 4
6.3	4	5	6	7	8	8	8			N 3
6.4	4	5	6	7	8	8	6	8		N 4
7.1	4	5	6	7	8	8	6	8		N 1
7.2	4	5	6	7	8	8	6	8		N 1
7.3	4	5	6	7	8	8	6	8		N 1
7.4	4	5	6	7	8	8	6	8		N 2
8.1										O
8.2										O
8.3										O
9.1										H
10.1										O

	Trubka Полая заготовка (труба) Tuleja Rúra		Kulatina Цельная заготовка(пруток) Pręt Plný materiál
---	---	---	--

- S802HA** • Drážkovací frézy
• Фрезы для обработки пазов
- S802HB** • Frezy palcowe do rowków na wpusty
• Drážkovacie frézy

S802HA; S802HB	▪	1.1	1.2	1.3	1.4	1.5	1.6	2.1	2.2	3.1	3.2	3.3	3.4	6.2	6.3	6.4	7.2	7.3	7.4
	•	2.3	2.4	4.1	4.2	5.1	5.2	6.1	7.1	8.1	8.2								

S802HA	HM		N	Z 2		λ 28° γ 9°	DIN 6535HA				DIN 6527K
S802HB	HM		N	Z 2		λ 28° γ 9°	DIN 6535HB				DIN 6527K

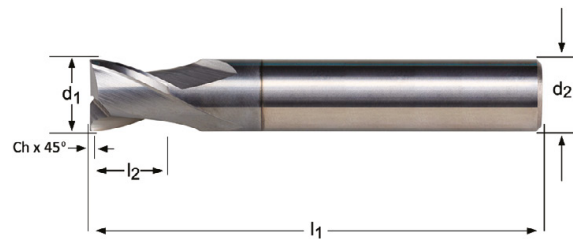

d ₁ Ø mm	Ch ±0.03x45° mm	d ₂ Øh ₆ mm	l ₂ mm	l ₁ mm	z	S802HA	S802HB
1.00	-	3	3	38	2	S802HA1.0	
1.50	-	3	3	38	2	S802HA1.5	
2.00	-	6	3	50	2	S802HA2.0	S802HB2.0
2.50	0.08	6	3	50	2	S802HA2.5	S802HB2.5
3.00	0.08	6	4	50	2	S802HA3.0	S802HB3.0
3.50	0.08	6	4	50	2	S802HA3.5	S802HB3.5
4.00	0.13	6	5	54	2	S802HA4.0	S802HB4.0
4.50	0.13	6	5	54	2	S802HA4.5	S802HB4.5
5.00	0.13	6	6	54	2	S802HA5.0	S802HB5.0
6.00	0.13	6	7	54	2	S802HA6.0	S802HB6.0
7.00	0.13	8	8	58	2	S802HA7.0	S802HB7.0
8.00	0.20	8	9	58	2	S802HA8.0	S802HB8.0 ¹⁾
9.00	0.20	10	10	66	2	S802HA9.0	S802HB9.0 ¹⁾
10.00	0.20	10	11	66	2	S802HA10.0	S802HB10.0 ¹⁾
12.00	0.20	12	12	73	2	S802HA12.0	S802HB12.0 ¹⁾
14.00	0.20	14	14	75	2	S802HA14.0	S802HB14.0 ¹⁾
16.00	0.20	16	16	82	2	S802HA16.0	S802HB16.0 ¹⁾
18.00	0.20	18	18	84	2	S802HA18.0	S802HB18.0 ¹⁾
20.00	0.30	20	20	92	2	S802HA20.0	S802HB20.0 ¹⁾

- S812HA** • Drážkovací frézy
• Фрезы для обработки пазов
- S812HB** • Frezy palcove do rowków na wpusty
• Drážkovacie frézy

S812HA; S812HB	1.1	1.2	1.3	1.4	1.5	1.6	2.1	2.2	2.3	3.1	3.2	3.3	3.4	4.1	4.2	5.1	5.2
	6.1	6.2	6.3	6.4	7.1	7.2	7.3	7.4	8.1	8.2							

S812HA	HM		N	Z 2		λ 28° γ 9°	DIN 6535HA			DIN 6527L
S812HB	HM		N	Z 2		λ 28° γ 9°	DIN 6535HB			DIN 6527L

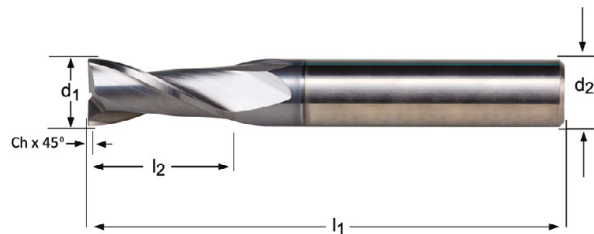

d_1 \varnothing mm	Ch $\pm 0.03 \times 45^\circ$ mm	d_2 $\varnothing h_8$ mm	l_2 mm	l_1 mm	z	S812HA	S812HB
2.00	-	6	6	57	2	S812HA2.0	S812HB2.0
2.50	0.08	6	7	57	2	S812HA2.5	S812HB2.5
3.00	0.08	6	7	57	2	S812HA3.0	S812HB3.0
3.50	0.08	6	7	57	2	S812HA3.5	S812HB3.5
4.00	0.13	6	8	57	2	S812HA4.0	S812HB4.0
4.50	0.13	6	8	57	2	S812HA4.5	S812HB4.5
5.00	0.13	6	10	57	2	S812HA5.0	S812HB5.0
6.00	0.13	6	10	57	2	S812HA6.0	S812HB6.0
7.00	0.13	8	13	63	2	S812HA7.0	S812HB7.0
8.00	0.20	8	16	63	2	S812HA8.0	S812HB8.0 ¹⁾
9.00	0.20	10	16	72	2	S812HA9.0	S812HB9.0 ¹⁾
10.00	0.20	10	19	72	2	S812HA10.0	S812HB10.0 ¹⁾
12.00	0.20	12	22	83	2	S812HA12.0	S812HB12.0 ¹⁾
14.00	0.20	14	22	83	2	S812HA14.0	S812HB14.0 ¹⁾
16.00	0.20	16	26	92	2	S812HA16.0	S812HB16.0 ¹⁾
18.00	0.20	18	26	92	2	S812HA18.0	S812HB18.0 ¹⁾
20.00	0.30	20	32	104	2	S812HA20.0	S812HB20.0 ¹⁾

¹⁾ Ch $\pm 0.05 \times 45^\circ$ mm

S822

- Drážkovací frézy
- Фрезы для обработки пазов
- Frezy palcowe do rowków na wpusty
- Drážkovacie frézy

S822	1.1	1.2	1.3	1.4	1.5	1.6	2.1	2.2	2.3	3.1	3.2	3.3	3.4	4.1	4.2	5.1	5.2	6.1	6.2	6.3
	6.4	7.1	7.2	7.3	7.4	8.1	8.2													

S822 **HM** **P9** **N** **Z** **2** λ **28°** γ **9°** **DIN 6535HA** **Alcrona** **DORMER**

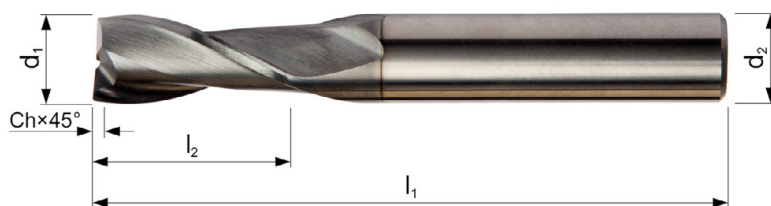

d_1 \emptyset mm	Ch $\pm 0.03 \times 45^\circ$ mm	d_2 $\emptyset h_6$ mm	l_2 mm	l_1 mm	z	S822
2.00	-	6	8	57	2	S8222.0
2.50	0.08	6	12	57	2	S8222.5
3.00	0.08	6	12	57	2	S8223.0
4.00	0.13	6	14	57	2	S8224.0
5.00	0.13	6	16	57	2	S8225.0
6.00	0.13	6	19	57	2	S8226.0
7.00	0.13	8	19	63	2	S8227.0
8.00	0.20	8	19	63	2	S8228.0 ¹⁾
9.00	0.20	10	21	72	2	S8229.0 ¹⁾
10.00	0.20	10	22	72	2	S82210.0 ¹⁾
12.00	0.20	12	25	83	2	S82212.0 ¹⁾
14.00	0.20	14	30	83	2	S82214.0 ¹⁾
16.00	0.20	16	32	92	2	S82216.0 ¹⁾
18.00	0.20	18	32	92	2	S82218.0 ¹⁾
20.00	0.30	20	38	104	2	S82220.0 ¹⁾

¹⁾ Ch $\pm 0.05 \times 45^\circ$ mm
392

S803HA • Drážkovací frézy
• Фрезы для обработки пазов

S803HB • Frezy palcowe do rowków na wpusty
• Drážkovacie frézy

S803HA; S803HB	▪	1.1	1.2	1.3	1.4	1.5	1.6	2.1	2.2	3.1	3.2	3.3	3.4	6.2	6.3	6.4	7.2	7.3	7.4
	•	2.3	2.4	4.1	4.2	5.1	5.2	6.1	7.1	8.1	8.2								

S803HA	HM		N	Z 3		λ 28° γ 9°	DIN 6535HA	Alcrona			DIN 6527K
S803HB	HM		N	Z 3		λ 28° γ 9°	DIN 6535HB	Alcrona			DIN 6527K

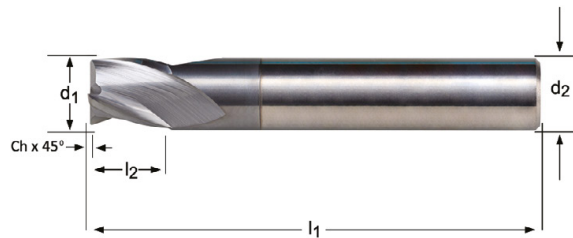

d ₁ Ø mm	Ch ±0.03x45° mm	d ₂ Ø _{h₆} mm	l ₂ mm	l ₁ mm	z	S803HA	S803HB
1.00	-	3	3	38	3	S803HA1.0	
1.50	-	3	3	38	3	S803HA1.5	
2.00	-	6	3	50	3	S803HA2.0	S803HB2.0
2.50	0.08	6	3	50	3	S803HA2.5	S803HB2.5
2.80	0.08	6	4	50	3	S803HA2.8	S803HB2.8
3.00	0.08	6	4	50	3	S803HA3.0	S803HB3.0
3.50	0.08	6	4	50	3	S803HA3.5	S803HB3.5
3.80	0.08	6	5	54	3	S803HA3.8	S803HB3.8
4.00	0.13	6	5	54	3	S803HA4.0	S803HB4.0
4.50	0.13	6	5	54	3	S803HA4.5	S803HB4.5
4.80	0.13	6	6	54	3	S803HA4.8	S803HB4.8
5.00	0.13	6	6	54	3	S803HA5.0	S803HB5.0
5.75	0.13	6	7	54	3		S803HB5.75
6.00	0.13	6	7	54	3	S803HA6.0	S803HB6.0
6.75	0.13	8	8	58	3		S803HB6.75
7.00	0.13	8	8	58	3	S803HA7.0	S803HB7.0
7.75	0.13	8	9	58	3		S803HB7.75
8.00	0.20	8	9	58	3	S803HA8.0	¹⁾ S803HB8.0
9.00	0.20	10	10	66	3	S803HA9.0	¹⁾ S803HB9.0
9.70	0.20	10	11	66	3		¹⁾ S803HB9.7
10.00	0.20	10	11	66	3	S803HA10.0	¹⁾ S803HB10.0
11.70	0.20	12	12	73	3		¹⁾ S803HB11.7
12.00	0.20	12	12	73	3	S803HA12.0	¹⁾ S803HB12.0
14.00	0.20	14	14	75	3	S803HA14.0	¹⁾ S803HB14.0
16.00	0.20	16	16	82	3	S803HA16.0	¹⁾ S803HB16.0
18.00	0.20	18	18	84	3	S803HA18.0	¹⁾ S803HB18.0
20.00	0.30	20	20	92	3	S803HA20.0	¹⁾ S803HB20.0

¹⁾ Ch ± 0.05x45° mm

- S813HA** • Drážkovací frézy
• Фрезы для обработки пазов
- S813HB** • Frezy palcowe do rowków na wpusty
• Drážkovacie frézy

S813HA; S813HB	▪	1.1	1.2	1.3	1.4	1.5	2.1	3.1	3.2	3.3	3.4	6.2	6.3	6.4	7.2	7.3	7.4
	•	1.6	2.2	2.3	4.1	4.2	5.1	5.2	6.1	7.1	8.1	8.2					

S813HA	HM		N	Z 3		λ 28° γ 9°	DIN 6535HA	Alcrona			DIN 6527L
S813HB	HM		N	Z 3		λ 28° γ 9°	DIN 6535HB	Alcrona			DIN 6527L

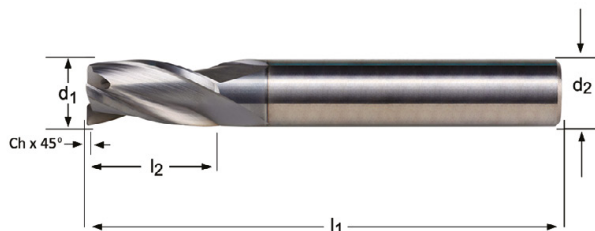

d_1 \emptyset mm	Ch $\pm 0.03 \times 45^\circ$ mm	d_2 $\emptyset h_6$ mm	l_2 mm	l_1 mm	z	S813HA	S813HB
2.00	0.00	6	6	57	3	S813HA2.0	S813HB2.0
2.50	0.08	6	7	57	3	S813HA2.5	S813HB2.5
3.00	0.08	6	7	57	3	S813HA3.0	S813HB3.0
3.50	0.08	6	7	57	3	S813HA3.5	S813HB3.5
4.00	0.13	6	8	57	3	S813HA4.0	S813HB4.0
4.50	0.13	6	8	57	3	S813HA4.5	S813HB4.5
5.00	0.13	6	10	57	3	S813HA5.0	S813HB5.0
6.00	0.13	6	10	57	3	S813HA6.0	S813HB6.0
7.00	0.13	8	13	63	3	S813HA7.0	S813HB7.0
8.00	0.20	8	16	63	3	S813HA8.0	S813HB8.0 ¹⁾
9.00	0.20	10	16	72	3	S813HA9.0	S813HB9.0 ¹⁾
10.00	0.20	10	19	72	3	S813HA10.0	S813HB10.0 ¹⁾
12.00	0.20	12	22	83	3	S813HA12.0	S813HB12.0 ¹⁾
14.00	0.20	14	22	83	3	S813HA14.0	S813HB14.0 ¹⁾
16.00	0.20	16	26	92	3	S813HA16.0	S813HB16.0 ¹⁾
18.00	0.20	18	26	92	3	S813HA18.0	S813HB18.0 ¹⁾
20.00	0.30	20	32	104	3	S813HA20.0	S813HB20.0 ¹⁾

- S823**
- Drážk. frézy
 - Фрезы для обработки пазов
 - Frezy palcowe do rowków na wpusty
 - Drážkovacie frézy

S823	▪	1.1	1.2	1.3	1.4	1.5	2.1	3.1	3.2	3.3	3.4	6.2	6.3	6.4	7.2	7.3	7.4	
	•	1.6	2.2	2.3	4.1	4.2	5.1	5.2	6.1	7.1	8.1	8.2						

S823

HM

P9

N

Z
3

λ 28°
 γ 9°

DIN
 6535HA

Alcrona

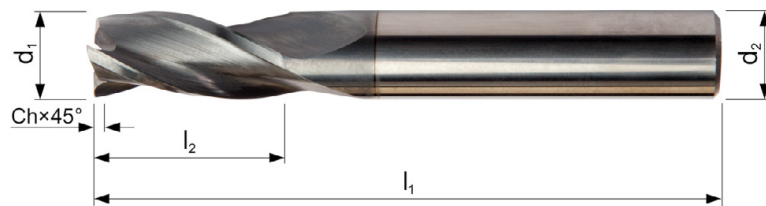

d_1 \varnothing mm	Ch $\pm 0.03 \times 45^\circ$ mm	d_2 $\varnothing h_6$ mm	l_2 mm	l_1 mm	z	S823
2.00	-	6	8	57	3	S8232.0
2.50	0.08	6	12	57	3	S8232.5
3.00	0.08	6	12	57	3	S8233.0
4.00	0.13	6	14	57	3	S8234.0
5.00	0.13	6	16	57	3	S8235.0
6.00	0.13	6	19	57	3	S8236.0
7.00	0.13	8	19	63	3	S8237.0
8.00	0.20	8	19	63	3	S8238.0 ¹⁾
9.00	0.20	10	21	72	3	S8239.0 ¹⁾
10.00	0.20	10	22	72	3	S82310.0 ¹⁾
12.00	0.20	12	25	83	3	S82312.0 ¹⁾
14.00	0.20	14	30	83	3	S82314.0 ¹⁾
16.00	0.20	16	32	92	3	S82316.0 ¹⁾
18.00	0.20	18	32	92	3	S82318.0 ¹⁾
20.00	0.30	20	38	104	3	S82320.0 ¹⁾

¹⁾ Ch $\pm 0.05 \times 45^\circ$ mm

S710

- Stopkové frézy
- Концевые фрезы
- Frezy walcowo-czołowe
- Stopkové frézy

S710 ■ 1.1 1.2 1.3 1.4 1.5 2.1 2.2 3.1 3.2 3.3 3.4 4.2 5.2

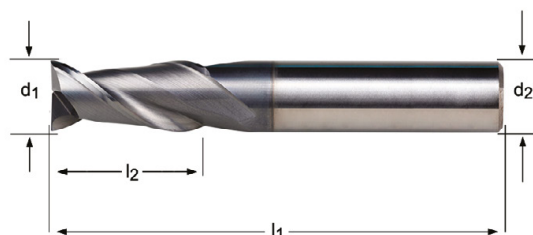
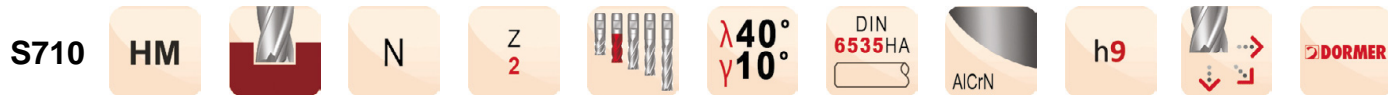

S710



1.00 - 20.00

d_1 Ø mm	d_2 Ø _{h6} mm	l_2 mm	l_1 mm	z	S710
1.00	3	3	40	2	S7101.0
1.50	3	4.5	40	2	S7101.5
2.00	3	6.5	40	2	S7102.0
2.50	3	6.5	40	2	S7102.5
3.00	6	9	50	2	S7103.0
4.00	6	12	50	2	S7104.0
5.00	6	15	50	2	S7105.0
6.00	6	20	60	2	S7106.0
8.00	8	20	64	2	S7108.0
10.00	10	22	75	2	S71010.0
12.00	12	25	75	2	S71012.0
16.00	16	32	90	2	S71016.0
20.00	20	38	100	2	S71020.0

S902 • Stopkové frézy
• Концевые фрезы

S922 • Frezy walcowo-czołowe
• Stopkové frézy

S902	▪	1.1	1.2	1.3	1.4	3.1	3.3	4.1	5.1	6.1	6.2	6.3			
	•	1.5	3.2	3.4	4.2	4.3	6.4	7.1	7.2	7.3	8.1	8.2	8.3		
S922	▪	1.1	1.2	1.3	1.4	1.5	3.1	3.2	3.3	3.4	4.1	5.1	6.1	6.2	6.3
	•	1.6	4.2	4.3	6.4	7.1	7.2	7.3	8.1	8.2	8.3				

S902	HM		N	Z 2		$\lambda 30^\circ$ $\gamma 12^\circ$	DIN 6535HA		h10			
S922	HM		N	Z 2		$\lambda 30^\circ$ $\gamma 12^\circ$	DIN 6535HB	TiAIN	h10			 437

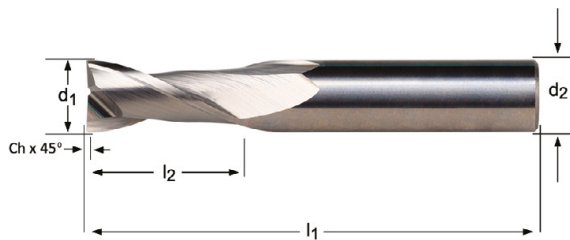

d ₁ Ø mm	Ch ±0.03x45° mm	d ₂ Øh ₆ mm	l ₂ mm	l ₁ mm	z	S902	S922
2.00	0.08	3	6	38	2	S9022.0	S9222.0 ²⁾
2.50	0.08	3	9	38	2	S9022.5	S9222.5 ²⁾
3.00	0.08	3	12	38	2	S9023.0	S9223.0 ²⁾
4.00	0.08	4	14	50	2	S9024.0	S9224.0 ²⁾
5.00	0.13	5	16	50	2	S9025.0	S9225.0 ²⁾
6.00	0.13	6	19	57	2	S9026.0	S9226.0
7.00	0.13	8	19	63	2	S9027.0	S9227.0
8.00	0.13	8	19	63	2	S9028.0	S9228.0
9.00	0.13	10	21	72	2	S9029.0	S9229.0
10.00	0.18	10	22	72	2	S90210.0	S92210.0
12.00	0.20	12	25	73	2	S90212.0 ¹⁾	S92212.0 ¹⁾
14.00	0.20	14	30	83	2	S90214.0 ¹⁾	S92214.0 ¹⁾
16.00	0.20	16	32	92	2	S90216.0 ¹⁾	S92216.0 ¹⁾
18.00	0.20	18	32	92	2	S90218.0 ¹⁾	S92218.0 ¹⁾
20.00	0.30	20	38	104	2	S90220.0 ¹⁾	S92220.0 ¹⁾

¹⁾ Ch ± 0.05x45° mm

²⁾ Válcová stopka / Цилиндрический хвостовик / Chwył cylindryczny (HA) / Valcová stopka

S713

- Stopkové frézy
- Концевые фрезы
- Frezy walcowo-czołowe
- Stopkové frézy

S713 ■ 1.1 1.2 1.3 1.4 1.5 2.1 2.2 3.1 3.2 3.3 3.4 4.2 5.2

S713 **HM**  **N** **Z 3**  **λ 40°**
γ 10° **DIN 6535HA**  **AlCrN** **h9**  **DORMER**

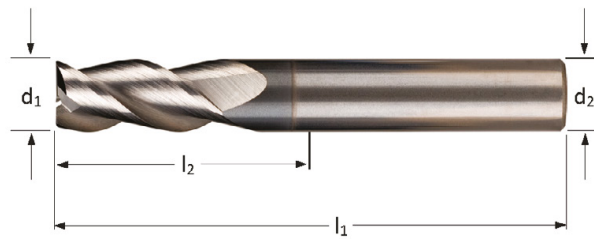

S713



1.50 - 20.00

d_1 Ø mm	d_2 Ø _{h₆} mm	l_2 mm	l_1 mm	z	S713
1.50	4	4.5	40	3	S7131.5
2.00	4	6.5	40	3	S7132.0
3.00	3	9	40	3	S7133.0
4.00	4	12	50	3	S7134.0
5.00	5	15	50	3	S7135.0
6.00	6	16	50	3	S7136.0
8.00	8	20	64	3	S7138.0
10.00	10	22	70	3	S71310.0
12.00	12	25	75	3	S71312.0
14.00	14	32	90	3	S71314.0
16.00	16	32	90	3	S71316.0
18.00	18	38	100	3	S71318.0
20.00	20	38	100	3	S71320.0

- S903** • Stopkové frézy
• Концевые фрезы
- S933** • Frezy walcowo-czołowe
• Stopkové frézy

S903	▪	1.1	1.2	1.3	1.4	3.1	3.3	4.1	5.1	6.1	6.2	6.3			
	•	1.5	3.2	3.4	4.2	4.3	6.4	7.1	7.2	7.3	8.1	8.2	8.3		
S933	▪	1.1	1.2	1.3	1.4	1.5	3.1	3.2	3.3	3.4	4.1	5.1	6.1	6.2	6.3
	•	1.6	4.2	4.3	6.4	7.1	7.2	7.3	8.1	8.2	8.3				

S903	HM		N	Z 3		$\lambda 30^\circ$ $\gamma 12^\circ$	DIN 6535HA		h10		DORMER	
S933	HM		N	Z 3		$\lambda 30^\circ$ $\gamma 12^\circ$	DIN 6535HB	TiAIN	h10		DORMER	S991 437

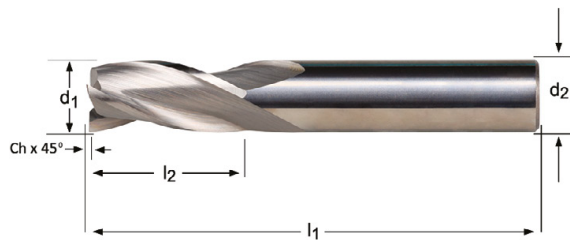

d ₁ Ø mm	Ch ±0.03x45° mm	d ₂ Øh ₆ mm	l ₂ mm	l ₁ mm	z	S903	S933
2.00	0.08	3	6	38	3	S9032.0	S9332.0 ²⁾
2.50	0.08	3	9	38	3	S9032.5	S9332.5 ²⁾
3.00	0.08	3	12	38	3	S9033.0	S9333.0 ²⁾
4.00	0.08	4	14	50	3	S9034.0	S9334.0 ²⁾
5.00	0.13	5	16	50	3	S9035.0	S9335.0 ²⁾
6.00	0.13	6	19	57	3	S9036.0	S9336.0
7.00	0.13	8	19	63	3	S9037.0	S9337.0
8.00	0.13	8	19	63	3	S9038.0	S9338.0
9.00	0.13	10	21	72	3	S9039.0	S9339.0
10.00	0.20	10	22	72	3	S90310.0	S93310.0 ¹⁾
12.00	0.20	12	25	73	3	S90312.0	S93312.0 ¹⁾
14.00	0.20	14	30	83	3	S90314.0	S93314.0 ¹⁾
16.00	0.20	16	32	92	3	S90316.0	S93316.0 ¹⁾
18.00	0.20	18	32	92	3	S90318.0	S93318.0 ¹⁾
20.00	0.30	20	38	104	3	S90320.0	S93320.0 ¹⁾

¹⁾ Ch ± 0.05x45° mm

²⁾ Válcová stopka / Цилиндрический хвостовик / Chwył cylindryczny (HA) / Válcová stopka

S714

- Stopkové frézy
- Концевые фрезы
- Frezy walcowo-czołowe
- Stopkové frézy

S714	▪	1.1	1.2	1.3	1.4	1.5	2.1	2.2	3.1	3.2	3.3	3.4	4.2	5.2
	•	6.1	6.2	6.3	6.4	7.1	7.2	7.3	7.4					

S714 **HM**  **N** **Z 3**  $\lambda 40^\circ$ $\gamma 10^\circ$ **DIN 6535HA**  **AlCrN** **h9**  **DORMER**

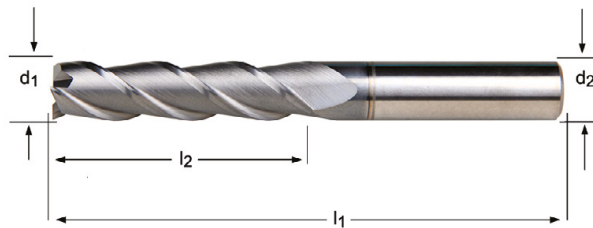

d_1 \varnothing mm	d_2 $\varnothing h_6$ mm	l_2 mm	l_1 mm	z	S714
3.00	3	19	60	3	S7143.0
4.00	4	19	60	3	S7144.0
5.00	5	19	60	3	S7145.0
6.00	6	31	75	3	S7146.0
8.00	8	31	75	3	S7148.0
10.00	10	31	75	3	S71410.0
12.00	12	50	100	3	S71412.0
14.00	14	57	125	3	S71414.0
16.00	16	57	125	3	S71416.0
18.00	18	57	125	3	S71418.0
20.00	20	57	125	3	S71420.0

S715

- Stopkové frézy
- Концевые фрезы
- Frezy walcowo-czołowe
- Stopkové frézy

S715	▪	1.1	1.2	1.3	1.4	1.5	2.1	2.2	3.1	3.2	3.3	3.4	4.2	5.2
	•	6.1	6.2	6.3	6.4	7.1	7.2	7.3	7.4					

S715 **HM** **N** **Z 3** **λ 40°** **γ 10°** **DIN 6535HA** **AICrN** **h9**

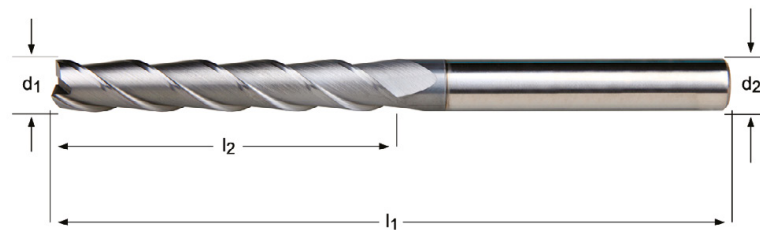

d_1 Ø mm	d_2 Ø _{h6} mm	l_2 mm	l_1 mm	z	S715
3.00	3	25	100	3	S7153.0
4.00	4	31	100	3	S7154.0
5.00	5	31	100	3	S7155.0
6.00	6	38	100	3	S7156.0
8.00	8	41	100	3	S7158.0
10.00	10	57	125	3	S71510.0
12.00	12	75	150	3	S71512.0
14.00	14	75	150	3	S71514.0
16.00	16	75	150	3	S71516.0
18.00	18	75	150	3	S71518.0
20.00	20	75	150	3	S71520.0

S637

- Stopkové frézy
- Концевые фрезы
- Frezy walcowo-czołowe
- Stopkové frézy

S637 ■ 6.1 6.2 6.3 6.4 7.1 7.2 7.3 7.4 8.1 8.2

S637 **HM**  **W** **Z 1**  **λ 25°**
γ 20° **DIN 6535HA**  **h9**  **DORMER**



S637



2.00 - 12.00

d_1 Ø mm	d_2 Ø _{h6} mm	l_2 mm	l_1 mm	z	S637
2.00	2	10	40	1	S6372.0
3.00	3	12	40	1	S6373.0
4.00	4	15	50	1	S6374.0
5.00	5	16	50	1	S6375.0
6.00	6	20	60	1	S6376.0
8.00	8	22	63	1	S6378.0
10.00	10	25	72	1	S63710.0
12.00	12	30	83	1	S63712.0

- S638**
- Stopkové frézy Zúžená stopka
 - Концевые фрезы Уменьшенный хвостовик
 - Frezy walcowo-czołowe Przewężony chwyt
 - Stopkové frézy Zúžená stopka

S638 ■ 6.1 6.2 6.3 6.4 7.1 7.2 7.3 7.4 8.1 8.2

S638 **HM** **W** **Z 2** **$\lambda 30^\circ$**
 $\gamma 20^\circ$ **Hi** **h9**

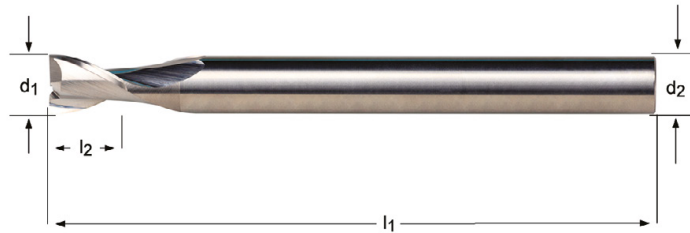

d_1 \varnothing mm	r ± 0.02 mm	d_2 $\varnothing h_6$ mm	l_2 mm	l_1 mm	z	S638
6.20	0.10	6	8	100	2	S6386.2
8.20	0.10	8	10	100	2	S6388.2
10.30	0.10	10	14	125	2	S63810.3
12.30	0.10	12	16	125	2	S63812.3
16.30	0.10	16	20	125	2	S63816.3
20.30	0.10	20	25	125	2	S63820.3

S610

- Stopkové frézy
- Концевые фрезы
- Frezy walcowo-czołowe
- Stopkové frézy

S610 ■ 6.1 6.2 6.3 6.4 7.1 7.2 7.3 7.4 8.1 8.2

S610 **HM**  **W** **Z 2**  **λ 30°**
γ 20° **DIN 6535HA**  **h9**  **DORMER**



d_1 ∅ mm	r ±0.02 mm	d_2 ∅ h_6 mm	l_2 mm	l_1 mm	z	S610
3.00	0.10	3	9	40	2	S6103.0XD3
3.00	0.10	6	9	50	2	S6103.0XD6
4.00	0.10	4	12	50	2	S6104.0XD4
4.00	0.10	6	12	50	2	S6104.0XD6
5.00	0.10	6	15	50	2	S6105.0
6.00	0.10	6	20	50	2	S6106.0
8.00	0.10	8	20	64	2	S6108.0
10.00	0.10	10	22	75	2	S61010.0
12.00	0.10	12	25	75	2	S61012.0
14.00	0.10	14	32	90	2	S61014.0
16.00	0.10	16	32	90	2	S61016.0
20.00	0.10	20	38	100	2	S61020.0

S611

- Stopkové frézy
- Концевые фрезы
- Frezy walcowo-czołowe
- Stopkové frézy

S611 ■ 6.1 6.2 6.3 6.4 7.1 7.2 7.3 7.4 8.1 8.2

S611 **HM** **W** **Z 2** **λ 30°** **γ 20°** **DIN 6535HA** **Hi** **h9** **DORMER**

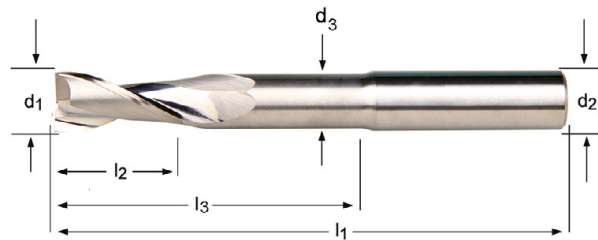

d_1 ∅ mm	r ±0.02 mm	d_2 ∅ _{h6} mm	l_2 mm	l_1 mm	z	l_3 mm	d_3 ∅ mm	S611
6.00	0.10	6	16	80	2	40.0	5.5	S6116.0
8.00	0.10	8	20	80	2	40.0	7.4	S6118.0
10.00	0.10	10	22	100	2	60.0	9.2	S61110.0
12.00	0.10	12	25	100	2	60.0	11.0	S61112.0
14.00	0.10	14	32	125	2	75.0	13.0	S61114.0
16.00	0.10	16	32	125	2	75.0	15.0	S61116.0
20.00	0.10	20	38	125	2	75.0	19.0	S61120.0

S804HA • Stopkové frézy
• Концевые фрезы

S804HB • Frezy walcowo-czołowe
• Stopkové frézy

S804HA; S804HB	▪	1.1	1.2	1.3	1.4	1.5	1.6	2.1	2.2	3.1	3.2	3.3	3.4	6.2	6.3	6.4
	•	2.3	2.4	4.1	4.2	5.1	5.2	6.1	7.1	7.2	7.3	7.4	8.1	8.2		

S804HA	HM		N	Z 4		λ 34° γ 9°	DIN 6535HA	Alcrona	h10		DIN 6527K
S804HB	HM		N	Z 4		λ 34° γ 9°	DIN 6535HB	Alcrona	h10		DIN 6527K

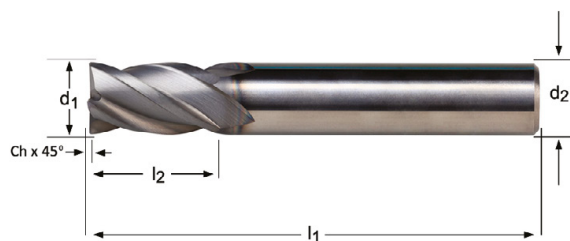

d ₁ Ø mm	Ch ±0.03x45° mm	d ₂ Øh ₆ mm	l ₂ mm	l ₁ mm	z	S804HA	S804HB
2.00	-	6	4	50	4	S804HA2.0	S804HB2.0
3.00	0.08	6	5	50	4	S804HA3.0	S804HB3.0
4.00	0.13	6	8	54	4	S804HA4.0	S804HB4.0
5.00	0.13	6	9	54	4	S804HA5.0	S804HB5.0
6.00	0.13	6	10	54	4	S804HA6.0	S804HB6.0
8.00	0.13	8	12	58	4	S804HA8.0	S804HB8.0
10.00	0.20	10	14	66	4	S804HA10.0	S804HB10.0 ¹⁾
12.00	0.20	12	16	73	4	S804HA12.0	S804HB12.0 ¹⁾
16.00	0.20	16	22	82	4	S804HA16.0	S804HB16.0 ¹⁾
20.00	0.30	20	26	92	4	S804HA20.0	S804HB20.0 ¹⁾
25.00	0.30	25	32	121	4	S804HA25.0	S804HB25.0 ¹⁾

S219

- Stopkové frézy
- Концевые фрезы
- Frezy walcowo-czołowe
- Stopkové frézy

S219 ■ 1.6 2.3 2.4 4.3 5.3

S219 **HM** **N** **Z 4** **$\lambda 40^\circ$** **$\gamma 3^\circ$** **DIN 6535HA** **AITIN** **h9**

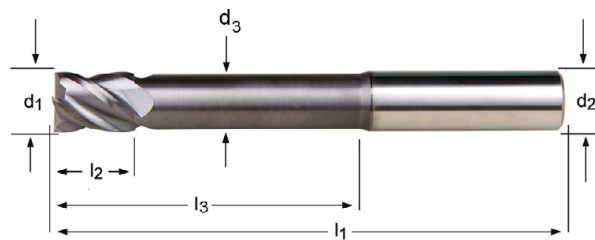

d_1 \varnothing mm	d_2 $\varnothing h_6$ mm	l_2 mm	l_1 mm	z	l_3 mm	d_3 \varnothing mm	S219
3.00	3	5	60	4	30.0	2.8	S2193.0
4.00	4	8	60	4	32.0	3.7	S2194.0
5.00	5	9	60	4	32.0	4.6	S2195.0
6.00	6	10	75	4	40.0	5.5	S2196.0
8.00	8	12	75	4	40.0	7.4	S2198.0
10.00	10	14	75	4	40.0	9.2	S21910.0
12.00	12	16	100	4	60.0	11.0	S21912.0
14.00	14	22	125	4	85.0	13.0	S21914.0
16.00	16	22	125	4	85.0	15.0	S21916.0
18.00	18	26	125	4	85.0	17.0	S21918.0
20.00	20	26	125	4	85.0	19.0	S21920.0

S814HA

- Stopkové frézy
- Концевые фрезы

S814HB

- Frezy walcowo-czołowe
- Stopkové frézy

S814HA; S814HB	▪	1.1	1.2	1.3	1.4	1.5	2.1	3.1	3.2	3.3	3.4	6.2	6.3	6.4				
	•	1.6	2.2	2.3	4.1	4.2	5.1	5.2	6.1	7.1	7.2	7.3	7.4	8.1	8.2			

S814HA	HM		N	Z 4		λ 34° γ 9°	DIN 6535HA	Alcrona	h10		DIN 6527L
S814HB	HM		N	Z 4		λ 34° γ 9°	DIN 6535HB	Alcrona	h10		DIN 6527L

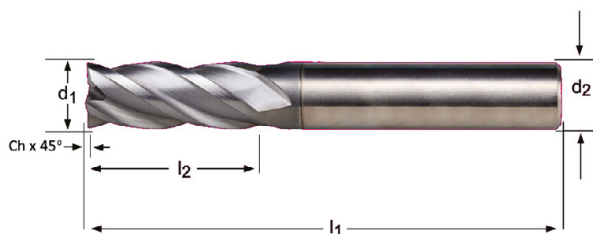

d ₁ ∅ mm	Ch ±0.03x45° mm	d ₂ ∅h ₆ mm	l ₂ mm	l ₁ mm	z	S814HA	S814HB
2.00	0.00	6	7	57	4	S814HA2.0	S814HB2.0
3.00	0.08	6	8	57	4	S814HA3.0	S814HB3.0
4.00	0.13	6	11	57	4	S814HA4.0	S814HB4.0
5.00	0.13	6	13	57	4	S814HA5.0	S814HB5.0
6.00	0.13	6	13	57	4	S814HA6.0	S814HB6.0
8.00	0.13	8	19	63	4	S814HA8.0	S814HB8.0
10.00	0.20	10	22	72	4	S814HA10.0	S814HB10.0 ¹⁾
12.00	0.20	12	26	83	4	S814HA12.0	S814HB12.0 ¹⁾
16.00	0.20	16	32	92	4	S814HA16.0	S814HB16.0 ¹⁾
20.00	0.30	20	38	104	4	S814HA20.0	S814HB20.0 ¹⁾
25.00	0.30	25	45	121	4	S814HA25.0	S814HB25.0 ¹⁾

¹⁾ Ch ± 0.05x45° mm
408

S716

- Stopkové frézy
- Концевые фрезы
- Frezy walcowo-czołowe
- Stopkové frézy

S716 ■ 1.1 1.2 1.3 1.4 1.5 2.1 2.2 3.1 3.2 3.3 3.4 4.2 5.2

S716 **HM** **N** **Z 4** **λ 40°**
γ 10° **DIN 6535HA** **AICrN** **h9**

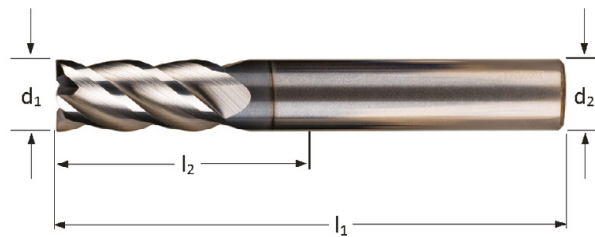

d_1 Ø mm	d_2 Ø _{h6} mm	l_2 mm	l_1 mm	z	S716
2.00	4	6.5	40	4	S7162.0
3.00	3	9	40	4	S7163.0
4.00	4	12	50	4	S7164.0
5.00	5	15	50	4	S7165.0
6.00	6	16	50	4	S7166.0
8.00	8	20	64	4	S7168.0
10.00	10	22	70	4	S71610.0
12.00	12	25	75	4	S71612.0
14.00	14	32	90	4	S71614.0
16.00	16	32	90	4	S71616.0
18.00	18	38	100	4	S71618.0
20.00	20	38	100	4	S71620.0

S612

- Stopkové frézy
- Концевые фрезы
- Frezy walcowo-czołowe
- Stopkové frézy

S612 ■ 10.1

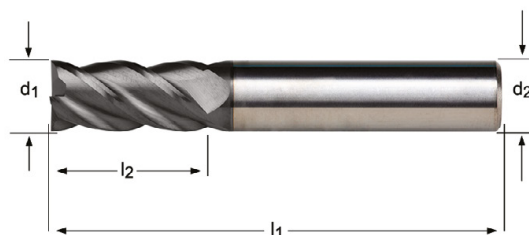

d_1 Ø mm	d_2 Ø _{h6} mm	l_2 mm	l_1 mm	z	S612
1.00	3	3	50	4	S6121.0
1.50	3	4.5	50	4	S6121.5
2.00	3	6.5	50	4	S6122.0
2.50	3	6.5	50	4	S6122.5
3.00	3	9	50	4	S6123.0
4.00	4	12	50	4	S6124.0
5.00	5	15	50	4	S6125.0
6.00	6	20	60	4	S6126.0
8.00	8	20	64	4	S6128.0
10.00	10	22	70	4	S61210.0
12.00	12	25	75	4	S61212.0

S216

- Stopkové frézy
- Концевые фрезы
- Frezy walcowo-czołowe
- Stopkové frézy

S216 ■ 1.6 2.3 2.4 4.3 5.3

S216 **HM** **N** **Z 4** $\lambda 40^\circ$ $\gamma 3^\circ$ **DIN 6535HA** **AITIN** **h9** **DORMER**

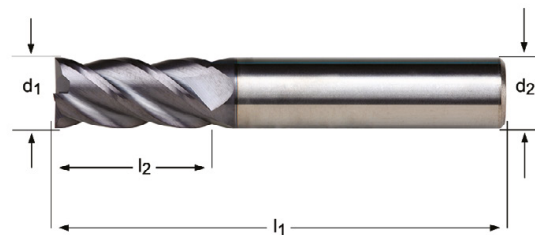

S216



2.00 - 20.00

d_1 \varnothing mm	d_2 $\varnothing h_6$ mm	l_2 mm	l_1 mm	z	S216
2.00	4	6.5	40	4	S2162.0
3.00	3	9	40	4	S2163.0XD3
3.00	6	9	50	4	S2163.0XD6
4.00	4	12	50	4	S2164.0XD4
4.00	6	12	50	4	S2164.0XD6
5.00	5	15	50	4	S2165.0
6.00	6	16	50	4	S2166.0
8.00	8	20	64	4	S2168.0
10.00	10	22	70	4	S21610.0
12.00	12	25	75	4	S21612.0
14.00	14	32	90	4	S21614.0
16.00	16	32	90	4	S21616.0
18.00	18	38	100	4	S21618.0
20.00	20	38	100	4	S21620.0

S904

- Stopkové frézy
- Концевые фрезы

S944

- Frezy walcowo-czołowe
- Stopkové frézy

S904	▪	1.1	1.2	1.3	1.4	3.1	3.3	4.1	5.1	6.1	6.2	6.3						
	•	1.5	1.6	3.2	3.4	4.2	4.3	5.2	5.3	6.4	7.1	7.2	7.3	8.1	8.2	8.3		
S944	▪	1.1	1.2	1.3	1.4	1.5	3.1	3.2	3.3	3.4	4.1	5.1	6.1	6.2	6.3			
	•	1.6	4.2	4.3	5.2	5.3	6.4	7.1	7.2	7.3	8.1	8.2	8.3					

S904	HM		N	Z 4		$\lambda 30^\circ$ $\gamma 12^\circ$	DIN 6535HA		h12		DORMER	
S944	HM		N	Z 4		$\lambda 30^\circ$ $\gamma 12^\circ$	DIN 6535HB	TiAIN	h12		DORMER	S991 437

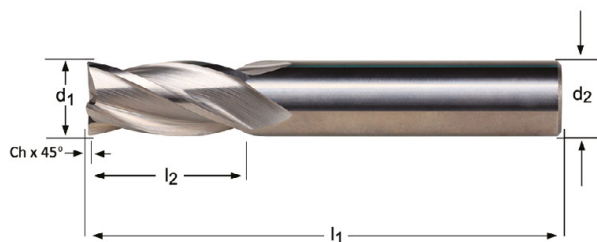

d ₁ Ø mm	Ch ±0.03x45° mm	d ₂ Øh ₆ mm	l ₂ mm	l ₁ mm	z	S904	S944
2.00	0.08	3	6	38	4	S9042.0	S9442.0 ²⁾
2.50	0.08	3	9	38	4	S9042.5	S9442.5 ²⁾
3.00	0.08	3	12	38	4	S9043.0	S9443.0 ²⁾
4.00	0.08	4	14	50	4	S9044.0	S9444.0 ²⁾
5.00	0.13	5	16	50	4	S9045.0	S9445.0 ²⁾
6.00	0.13	6	19	57	4	S9046.0	S9446.0
7.00	0.13	8	19	63	4	S9047.0	S9447.0
8.00	0.13	8	19	63	4	S9048.0	S9448.0
9.00	0.13	10	21	72	4	S9049.0	S9449.0
10.00	0.20	10	22	72	4	S90410.0	S94410.0 ¹⁾
12.00	0.20	12	25	73	4	S90412.0	S94412.0 ¹⁾
14.00	0.20	14	30	83	4	S90414.0	S94414.0 ¹⁾
16.00	0.20	16	32	92	4	S90416.0	S94416.0 ¹⁾
18.00	0.20	18	32	92	4	S90418.0	S94418.0 ¹⁾
20.00	0.30	20	38	104	4	S90420.0	S94420.0 ¹⁾

¹⁾ Ch ± 0.05x45° mm

²⁾ Válcová stopka / Цилиндрический хвостовик / Chwył cylindryczny (HA) / Valcová stopka

- S717** • Stopkové frézy
• Концевые фрезы
- S217** • Frezy walcowo-czołowe
• Stopkové frézy

S717	▪	1.1	1.2	1.3	1.4	1.5	2.1	2.2	3.1	3.2	3.3	3.4	4.2	5.2
	•	6.1	6.2	6.3	6.4	7.1	7.2	7.3	7.4					
S217	▪	1.6	2.3	2.4	4.3	5.3								

S717	HM		N	Z 4		$\lambda 40^\circ$ $\gamma 10^\circ$	DIN 6535HA		AICrN	h9		
S217	HM		N	Z 4		$\lambda 40^\circ$ $\gamma 3^\circ$	DIN 6535HA		AlTiN	h9		

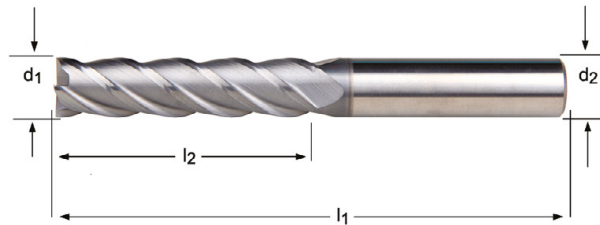

d_1 \varnothing mm	d_2 $\varnothing h_6$ mm	l_2 mm	l_1 mm	z	S717	S217
3.00	3	19	60	4	S7173.0	S2173.0XD3
3.00	6	19	75	4		S2173.0XD6
4.00	4	19	60	4	S7174.0	S2174.0XD4
4.00	6	19	75	4		S2174.0XD6
5.00	5	19	60	4	S7175.0	S2175.0
6.00	6	31	75	4	S7176.0	S2176.0
8.00	8	31	75	4	S7178.0	S2178.0
10.00	10	31	75	4	S71710.0	S21710.0
12.00	12	50	100	4	S71712.0	S21712.0
14.00	14	57	125	4	S71714.0	S21714.0
16.00	16	57	125	4	S71716.0	S21716.0
18.00	18	57	125	4	S71718.0	S21718.0
20.00	20	57	125	4	S71720.0	S21720.0

S718 • Stopkové frézy
• Концевые фрезы

S218 • Frezy walcowo-czołowe
• Stopkové frézy

S718	▪	1.1	1.2	1.3	1.4	1.5	2.1	2.2	3.1	3.2	3.3	3.4	4.2	5.2
	•	6.1	6.2	6.3	6.4	7.1	7.2	7.3	7.4					
S218	▪	1.6	2.3	2.4	4.3	5.3								

S718	HM		N	Z 4		$\lambda 40^\circ$ $\gamma 10^\circ$	DIN 6535HA	AlCrN	h9		
S218	HM		N	Z 4		$\lambda 40^\circ$ $\gamma 3^\circ$	DIN 6535HA	AlTiN	h9		

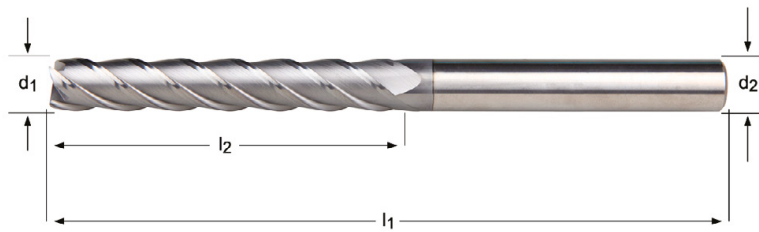

d_1 \emptyset mm	d_2 $\emptyset h_6$ mm	l_2 mm	l_1 mm	z	S718	S218
3.00	3	25	100	4	S7183.0	S2183.0
4.00	4	31	100	4	S7184.0	S2184.0
5.00	5	31	100	4	S7185.0	S2185.0
6.00	6	38	100	4	S7186.0	S2186.0
8.00	8	41	100	4	S7188.0	S2188.0
10.00	10	57	125	4	S71810.0	S21810.0
12.00	12	75	150	4	S71812.0	S21812.0
14.00	14	75	150	4	S71814.0	S21814.0
16.00	16	75	150	4	S71816.0	S21816.0
18.00	18	75	150	4	S71818.0	S21818.0
20.00	20	75	150	4	S71820.0	S21820.0

- S761** • Stopkové frézy
• Концевые фрезы
- S260** • Frezy walcowo-czołowe
• Stopkové frézy

S761	▪	1.1	1.2	1.3	1.4	1.5	2.1	2.2	3.1	3.2	3.3	3.4	4.2	5.2
S260	▪	1.6	1.7	2.3	2.4	4.3	5.3							

S761	HM		N	Z 4		$\lambda 40^\circ$ $\gamma 10^\circ$	DIN 6535HA	AICrN	h9		
S260	HM		N	Z 4		$\lambda 40^\circ$ $\gamma 4^\circ$	DIN 6535HA	AICrN	h9		

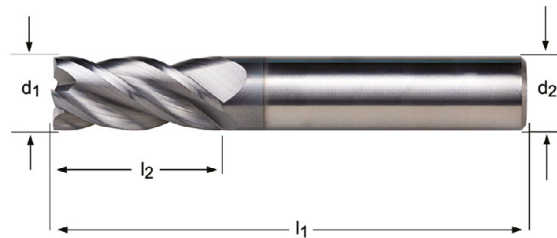









d_1 \varnothing mm	d_2 $\varnothing h_6$ mm	l_2 mm	l_1 mm	z	S761	S260
3.00	6	9	57	4	S7613.0	S2603.0
4.00	6	12	57	4	S7614.0	S2604.0
5.00	6	13	57	4	S7615.0	S2605.0
6.00	6	13	57	4	S7616.0	S2606.0
8.00	8	20	64	4	S7618.0	S2608.0
10.00	10	22	72	4	S76110.0	S26010.0
12.00	12	26	83	4	S76112.0	S26012.0
14.00	14	32	83	4	S76114.0	S26014.0
16.00	16	32	92	4	S76116.0	S26016.0
18.00	18	38	92	4		S26018.0
20.00	20	38	104	4	S76120.0	S26020.0

S766

- Stopkové frézy
- Концевые фрезы
- Frezy walcowo-czołowe
- Stopkové frézy

S766 ■ 1.1 1.2 1.3 1.4 1.5 2.1 2.2 3.1 3.2 3.3 3.4 4.2 5.2

S766 **HM**  **N**      **h9**  

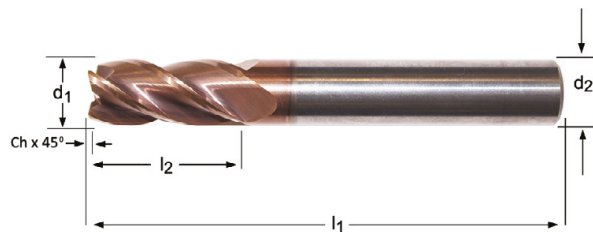

d_1 Ø mm	Ch ±0.02x45° mm	d_2 Ø _{h6} mm	l_2 mm	l_1 mm	z	S766
4.00	0.10	6	11	57	4	S7664.0
5.00	0.10	6	13	57	4	S7665.0
6.00	0.10	6	13	57	4	S7666.0
8.00	0.20	8	20	64	4	S7668.0
10.00	0.20	10	22	72	4	S76610.0
12.00	0.20	12	26	83	4	S76612.0
14.00	0.30	14	26	83	4	S76614.0
16.00	0.30	16	32	92	4	S76616.0
20.00	0.40	20	38	104	4	S76620.0

- S225** • Dokončovaci frézy
 • Чистовые концевые фрезы
- S525** • Frezy walcowo-czołowe do obróbki wykańczającej
 • Dokončovacie frézy

S225	▪	1.6	2.3	2.4	4.3	5.3
S525	▪	1.7	1.8			

S225	HM		N	Z 6-8		$\lambda 50^\circ$ $\gamma 3^\circ$	DIN 6535HA		h9		
S525	HM		N	Z 6-8		$\lambda 50^\circ$ $\gamma -26^\circ$	DIN 6535HA		h9		

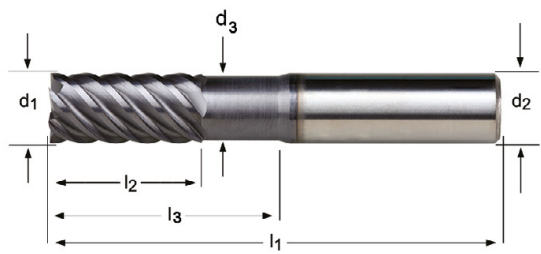

d_1 Ø mm	d_2 Ø _{h6} mm	l_2 mm	l_1 mm	z	l_3 mm	d_3 Ø mm	S225	S525
3.00	6	8	50	6	20.0	2.8	S2253.0	S5253.0
4.00	6	11	50	6	20.0	3.7	S2254.0	S5254.0
6.00	6	15	50	6	20.0	5.5	S2256.0	S5256.0
8.00	8	20	64	6	30.0	7.4	S2258.0	S5258.0
10.00	10	22	70	6	32.0	9.2	S22510.0	S52510.0
12.00	12	25	75	6	37.0	11.0	S22512.0	S52512.0
14.00	14	30	90	6	44.0	13.0	S22514.0	S52514.0
16.00	16	30	90	8	46.0	15.0	S22516.0	S52516.0
18.00	18	35	100	8	53.0	17.0	S22518.0	S52518.0
20.00	20	38	100	8	58.0	19.0	S22520.0	S52520.0

- S226** • Dokončovaci frézy
• Чистовые концевые фрезы
- S526** • Frezy walcowo-czołowe do obróbki wykańczającej
• Dokončovacie frézy

S226 ■ 1.6 2.3 2.4 4.3 5.3

S526 ■ 1.7 1.8

S226	HM		N	Z 6-8		$\lambda 50^\circ$ $\gamma 3^\circ$	DIN 6535HA		h9	
S526	HM		N	Z 6-8		$\lambda 50^\circ$ $\gamma -26^\circ$	DIN 6535HA		h9	

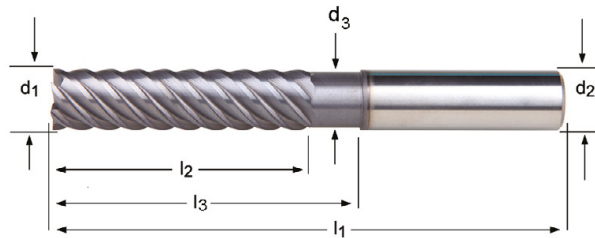

d_1 \emptyset mm	d_2 $\emptyset h_9$ mm	l_2 mm	l_1 mm	z	l_3 mm	d_3 \emptyset mm	S226	S526
3.00	6	19	75	6	30.0	2.8	S2263.0	S5263.0
4.00	6	19	75	6	32.0	3.7	S2264.0	S5264.0
6.00	6	31	75	6	40.0	5.5	S2266.0	S5266.0
8.00	8	31	75	6	40.0	7.4	S2268.0	S5268.0
10.00	10	45	100	6	60.0	9.2	S22610.0	S52610.0
12.00	12	50	100	6	60.0	11.0	S22612.0	S52612.0
14.00	14	57	125	6	85.0	13.0	S22614.0	S52614.0
16.00	16	57	125	8	85.0	15.0	S22616.0	S52616.0
18.00	18	57	125	8	85.0	17.0	S22618.0	S52618.0
20.00	20	57	125	8	85.0	19.0	S22620.0	S52620.0

- S227** • Dokončovacie frézy
 • Чистовые концевые фрезы
- S527** • Frezy walcowo-czołowe do obróbki wykańczającej
 • Dokončovacie frézy

S227 ▫ 1.6 2.3 2.4 4.3 5.3

S527 ▫ 1.7 1.8



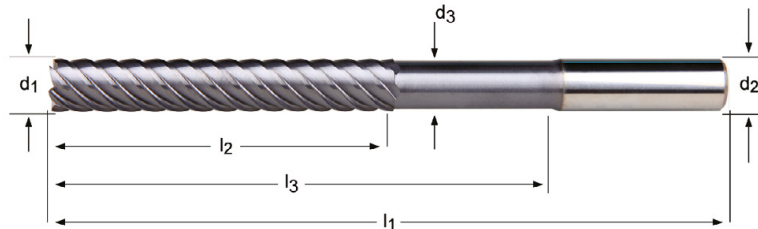



S227	HM		N	Z 6-8		$\lambda 50^\circ$ $\gamma 3^\circ$	DIN 6535HA		h9	
S527	HM		N	Z 6-8		$\lambda 50^\circ$ $\gamma -26^\circ$	DIN 6535HA		h9	



d_1 Ø mm	d_2 Ø _{h6} mm	l_2 mm	l_1 mm	z	l_3 mm	d_3 Ø mm	S227	S527
3.00	6	25	100	6	60.0	2.8		S5273.0
4.00	6	31	100	6	60.0	3.7		S5274.0
6.00	6	38	100	6	60.0	5.5	S2276.0	S5276.0
8.00	8	41	100	6	60.0	7.4	S2278.0	S5278.0
10.00	10	57	125	6	85.0	9.2	S22710.0	S52710.0
12.00	12	75	150	6	110.0	11.0	S22712.0	S52712.0
14.00	14	75	150	6	110.0	13.0	S22714.0	
16.00	16	75	150	8	110.0	15.0	S22716.0	S52716.0
18.00	18	75	150	8	110.0	17.0	S22718.0	
20.00	20	75	150	8	110.0	19.0	S22720.0	S52720.0

- S765**
- Hrubovací frézy
 - Черновые концевые фрезы
 - Frezy walcowo-czołowe do obróbki zgrubnej
 - Hrubovacie frézy

S765 ■ 1.1 1.2 1.3 1.4 1.5 2.1 2.2 3.1 3.2 3.3 3.4 4.2 5.2

S765 **HM**  **NR**  **Z 4**   **λ 40°**
 γ 10°  **AlCrN**  

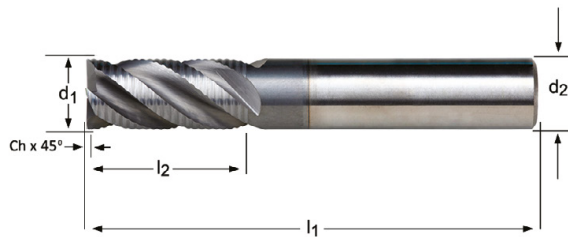

S765



6.00 - 20.00

d_1 \varnothing mm	Ch $\pm 0.02 \times 45^\circ$ mm	d_2 $\varnothing h_6$ mm	l_2 mm	l_1 mm	z	S765
6.00	0.10	6	16	50	4	S7656.0
8.00	0.20	8	20	64	4	S7658.0
10.00	0.20	10	22	70	4	S76510.0
12.00	0.20	12	26	75	4	S76512.0
14.00	0.30	14	32	90	4	S76514.0
16.00	0.30	16	32	90	4	S76516.0
18.00	0.30	18	38	100	4	S76518.0
20.00	0.40	20	38	100	4	S76520.0

S264

- Hrubovací frézy
- Черновые концевые фрезы
- Frezy walcowo-czołowe do obróbki zgrubnej
- Hrubovacie frézy

S264 ■ 1.6 1.7 2.3 2.4 4.3 5.3

S264 **HM** **NR** **Z 4** $\lambda 40^\circ$ $\gamma 4^\circ$ **DIN 6535HB** **h9**

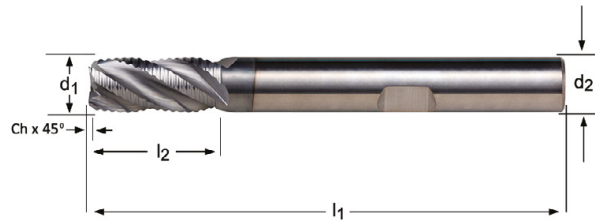

d_1 \varnothing mm	Ch $\pm 0.02 \times 45^\circ$ mm	d_2 $\varnothing h_6$ mm	l_2 mm	l_1 mm	z	S264
6.00	0.10	6	13	57	4	S2646.0
8.00	0.20	8	20	64	4	S2648.0
10.00	0.20	10	22	72	4	S26410.0
12.00	0.20	12	26	83	4	S26412.0
14.00	0.30	14	26	83	4	S26414.0
16.00	0.30	16	32	92	4	S26416.0
18.00	0.30	18	32	92	4	S26418.0
20.00	0.40	20	38	104	4	S26420.0

- S524**
- Stopkové frézy s rádiusem
 - Тороидальные концевые фрезы
 - Frezy walcowo-czołowe z promieniem naroża
 - Stopkové frézy s rádiusom

S524 ■ 1.7 1.8

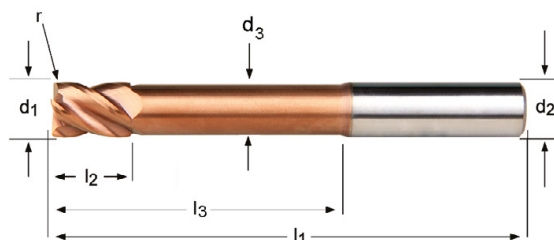

S524



3.00 - 16.00

d_1 \emptyset mm	r ± 0.01 mm	d_2 $\emptyset h_6$ mm	l_2 mm	l_1 mm	z	l_3 mm	d_3 \emptyset mm	S524
3.00	0.30	6	5	75	4	30.0	2.8	S5243.0XR0.3
4.00	0.30	6	8	75	4	32.0	3.7	S5244.0XR0.3
4.00	0.50	6	8	75	4	32.0	3.7	S5244.0XR0.5
5.00	0.30	6	9	75	4	32.0	4.6	S5245.0XR0.3
5.00	0.50	6	9	75	4	32.0	4.6	S5245.0XR0.5
6.00	0.30	6	10	75	4	40.0	5.5	S5246.0XR0.3
6.00	0.50	6	10	75	4	40.0	5.5	S5246.0XR0.5
6.00	1.00	6	10	75	4	40.0	5.5	S5246.0XR1.0
8.00	0.30	8	12	75	4	40.0	7.4	S5248.0XR0.3
8.00	0.50	8	12	75	4	40.0	7.4	S5248.0XR0.5
8.00	1.00	8	12	75	4	40.0	7.4	S5248.0XR1.0
10.00	0.50	10	14	75	4	40.0	9.2	S52410.0XR0.5
10.00	1.00	10	14	75	4	40.0	9.2	S52410.0XR1.0
10.00	2.00	10	14	75	4	40.0	9.2	S52410.0XR2.0
12.00	0.50	12	16	100	4	60.0	11.0	S52412.0XR0.5
12.00	1.00	12	16	100	4	60.0	11.0	S52412.0XR1.0
12.00	2.00	12	16	100	4	60.0	11.0	S52412.0XR2.0
16.00	0.50	16	22	125	4	85.0	15.0	S52416.0XR0.5
16.00	1.00	16	22	125	4	85.0	15.0	S52416.0XR1.0
16.00	2.00	16	22	125	4	85.0	15.0	S52416.0XR2.0
16.00	3.00	16	22	125	4	85.0	15.0	S52416.0XR3.0

S521

- Stopkové frézy s radiusem
- Торoidalные концевые фрезы
- Frezy walcowo-czołowe z promieniem naroża
- Stopkové frézy s rádiusom

S521 ■ 1.7 1.8

S521

HM



N

Z

4



$\lambda 45^\circ$
 $\gamma -10^\circ$

DIN
6535HA



TISIN

h9



DORMER

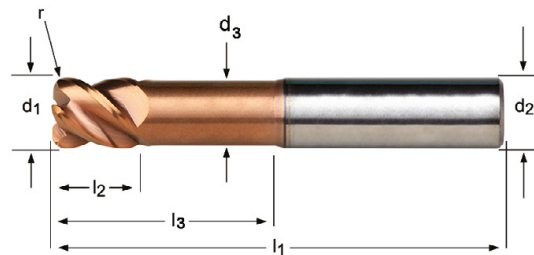

S521



3.00 - 16.00

d_1 \varnothing mm	r ± 0.01 mm	d_2 $\varnothing h_6$ mm	l_2 mm	l_1 mm	z	l_3 mm	d_3 \varnothing mm	S521
3.00	0.30	6	4	60	4	14.0	2.8	S5213.0XR0.3
4.00	0.30	6	5	60	4	16.0	3.7	S5214.0XR0.3
4.00	0.50	6	5	60	4	16.0	3.7	S5214.0XR0.5
5.00	0.30	6	6	60	4	18.0	4.6	S5215.0XR0.3
5.00	0.50	6	6	60	4	18.0	4.6	S5215.0XR0.5
6.00	0.50	6	7	60	4	20.0	5.5	S5216.0XR0.5
6.00	1.00	6	7	60	4	20.0	5.5	S5216.0XR1.0
8.00	0.50	8	9	64	4	26.0	7.4	S5218.0XR0.5
8.00	1.00	8	9	64	4	26.0	7.4	S5218.0XR1.0
10.00	1.00	10	11	70	4	31.0	9.2	S52110.0XR1.0
10.00	2.00	10	11	70	4	31.0	9.2	S52110.0XR2.0
12.00	1.00	12	13	75	4	37.0	11.0	S52112.0XR1.0
12.00	2.00	12	13	75	4	37.0	11.0	S52112.0XR2.0
16.00	1.00	16	17	90	4	43.0	15.0	S52116.0XR1.0
16.00	2.00	16	17	90	4	43.0	15.0	S52116.0XR2.0
16.00	3.00	16	17	90	4	43.0	15.0	S52116.0XR3.0

- S523**
- Stopkové frézy s radiusem
 - Тороидальные концевые фрезы
 - Frezy walcowo-czołowe z promieniem naroża
 - Stopkové frézy s rádiusom

S523 ■ 1.7 1.8

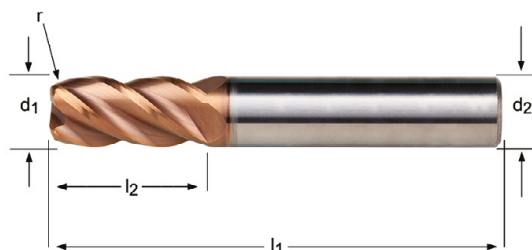

d_1 Ø mm	r ±0.01 mm	d_2 Ø _{h6} mm	l_2 mm	l_1 mm	z	S523
1.50	0.20	6	4.5	50	4	S5231.5XR0.2
2.00	0.20	6	6.5	50	4	S5232.0XR0.2
3.00	0.20	3	9	50	4	S5233.0XR0.2XD3
3.00	0.30	3	9	50	4	S5233.0XR0.3XD3
3.00	0.20	6	9	50	4	S5233.0XR0.2XD6
3.00	0.30	6	9	50	4	S5233.0XR0.3XD6
3.00	0.50	6	9	50	4	S5233.0XR0.5XD6
4.00	0.30	4	12	50	4	S5234.0XR0.3XD4
4.00	0.50	4	12	50	4	S5234.0XR0.5XD4
4.00	0.30	6	12	50	4	S5234.0XR0.3XD6
4.00	0.50	6	12	50	4	S5234.0XR0.5XD6
5.00	0.30	5	15	50	4	S5235.0XR0.3XD5
5.00	0.50	5	15	50	4	S5235.0XR0.5XD5
5.00	0.30	6	15	50	4	S5235.0XR0.3XD6
5.00	0.50	6	15	50	4	S5235.0XR0.5XD6
6.00	0.30	6	16	50	4	S5236.0XR0.3
6.00	0.50	6	16	50	4	S5236.0XR0.5
6.00	1.00	6	16	50	4	S5236.0XR1.0
8.00	0.30	8	20	64	4	S5238.0XR0.3
8.00	0.50	8	20	64	4	S5238.0XR0.5
8.00	1.00	8	20	64	4	S5238.0XR1.0
8.00	2.00	8	20	64	4	S5238.0XR2.0
10.00	0.50	10	22	70	4	S52310.0XR0.5
10.00	1.00	10	22	70	4	S52310.0XR1.0
10.00	1.50	10	22	70	4	S52310.0XR1.5
10.00	2.00	10	22	70	4	S52310.0XR2.0
12.00	0.50	12	25	75	4	S52312.0XR0.5
12.00	1.00	12	25	75	4	S52312.0XR1.0
12.00	2.00	12	25	75	4	S52312.0XR2.0
12.00	3.00	12	25	75	4	S52312.0XR3.0
16.00	0.50	16	32	90	4	S52316.0XR0.5
16.00	1.00	16	32	90	4	S52316.0XR1.0
16.00	2.00	16	32	90	4	S52316.0XR2.0
16.00	3.00	16	32	90	4	S52316.0XR3.0

- S763**
- Stopkové frézy s radiusem
 - Торoidalные концевые фрезы
 - Frezy walcowo-czołowe z promieniem naroża
 - Stopkové frézy s rádiusom

S763 ■ 1.1 1.2 1.3 1.4 1.5 2.1 2.2 3.1 3.2 3.3 3.4 4.2 5.2

S763 **HM** **N** $\lambda 40^\circ$ $\gamma 10^\circ$ **h9**

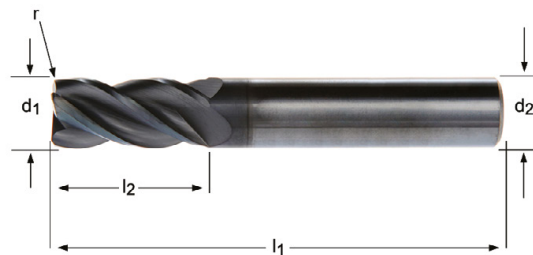

d_1 \varnothing mm	r ± 0.01 mm	d_2 $\varnothing h_6$ mm	l_2 mm	l_1 mm	z	S763
3.00	0.30	3	9	40	4	S7633.0XR0.3
4.00	0.30	4	12	50	4	S7634.0XR0.3
4.00	0.50	4	12	50	4	S7634.0XR0.5
5.00	0.30	5	15	50	4	S7635.0XR0.3
5.00	0.50	5	15	50	4	S7635.0XR0.5
6.00	0.50	6	16	50	4	S7636.0XR0.5
6.00	1.00	6	16	50	4	S7636.0XR1.0
8.00	0.50	8	20	64	4	S7638.0XR0.5
8.00	1.00	8	20	64	4	S7638.0XR1.0
10.00	0.50	10	22	70	4	S76310.0XR0.5
10.00	1.00	10	22	70	4	S76310.0XR1.0
10.00	2.00	10	22	70	4	S76310.0XR2.0
12.00	1.00	12	25	75	4	S76312.0XR1.0
12.00	2.00	12	25	75	4	S76312.0XR2.0
12.00	3.00	12	25	75	4	S76312.0XR3.0
14.00	1.50	14	32	90	4	S76314.0XR1.5
16.00	1.00	16	32	90	4	S76316.0XR1.0
16.00	2.00	16	32	90	4	S76316.0XR2.0
16.00	3.00	16	32	90	4	S76316.0XR3.0
18.00	2.00	18	38	100	4	S76318.0XR2.0
20.00	3.00	20	38	100	4	S76320.0XR3.0

S262

- Stopkové frézy s radiusem
- Тороидальные концевые фрезы
- Frezy walcowo-czołowe z promieniem naroża
- Stopkové frézy s rádiusom

S262 ■ 1.6 1.7 2.3 2.4 4.3 5.3

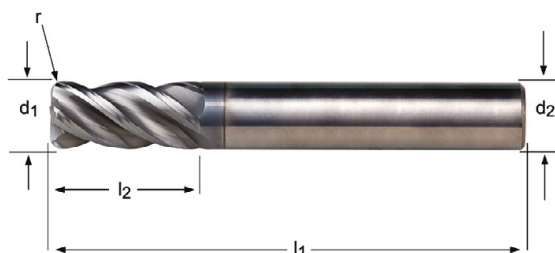

d_1 Ø mm	r ±0.01 mm	d_2 Ø h_6 mm	l_2 mm	l_1 mm	z	S262
3.00	0.30	6	9	50	4	S2623.0XR0.3
3.00	0.50	6	9	50	4	S2623.0XR0.5
4.00	0.30	6	12	57	4	S2624.0XR0.3
4.00	0.50	6	12	57	4	S2624.0XR0.5
4.00	1.00	6	12	57	4	S2624.0XR1.0
5.00	0.30	6	15	57	4	S2625.0XR0.3
5.00	0.50	6	15	57	4	S2625.0XR0.5
6.00	0.30	6	16	57	4	S2626.0XR0.3
6.00	0.50	6	16	57	4	S2626.0XR0.5
6.00	1.00	6	16	57	4	S2626.0XR1.0
8.00	0.30	8	20	64	4	S2628.0XR0.3
8.00	0.50	8	20	64	4	S2628.0XR0.5
8.00	1.00	8	20	64	4	S2628.0XR1.0
8.00	1.50	8	20	64	4	S2628.0XR1.5
8.00	2.00	8	20	64	4	S2628.0XR2.0
10.00	0.30	10	22	72	4	S26210.0XR0.3
10.00	0.50	10	22	72	4	S26210.0XR0.5
10.00	1.00	10	22	72	4	S26210.0XR1.0
10.00	1.50	10	22	72	4	S26210.0XR1.5
10.00	2.00	10	22	72	4	S26210.0XR2.0
12.00	0.30	12	26	83	4	S26212.0XR0.3
12.00	0.50	12	26	83	4	S26212.0XR0.5
12.00	1.00	12	26	83	4	S26212.0XR1.0
12.00	2.00	12	26	83	4	S26212.0XR2.0
12.00	2.50	12	26	83	4	S26212.0XR2.5
12.00	3.00	12	26	83	4	S26212.0XR3.0
14.00	0.30	14	32	83	4	S26214.0XR0.3
14.00	0.50	14	32	83	4	S26214.0XR0.5
14.00	1.00	14	32	83	4	S26214.0XR1.0
14.00	2.00	14	32	83	4	S26214.0XR2.0
14.00	3.00	14	32	83	4	S26214.0XR3.0
16.00	0.30	16	32	92	4	S26216.0XR0.3
16.00	0.50	16	32	92	4	S26216.0XR0.5
16.00	1.00	16	32	92	4	S26216.0XR1.0
16.00	2.00	16	32	92	4	S26216.0XR2.0
16.00	2.50	16	32	92	4	S26216.0XR2.5
16.00	3.00	16	32	92	4	S26216.0XR3.0
16.00	4.00	16	32	92	4	S26216.0XR4.0
18.00	0.30	18	38	92	4	S26218.0XR0.3
18.00	0.50	18	38	92	4	S26218.0XR0.5

d_1 Ø mm	r ±0.01 mm	d_2 Ø _{h₅} mm	l_2 mm	l_1 mm	z	S262
18.00	1.00	18	38	92	4	S26218.0XR1.0
18.00	2.00	18	38	92	4	S26218.0XR2.0
18.00	3.00	18	38	92	4	S26218.0XR3.0
20.00	0.30	20	38	104	4	S26220.0XR0.3
20.00	0.50	20	38	104	4	S26220.0XR0.5
20.00	1.00	20	38	104	4	S26220.0XR1.0
20.00	2.00	20	38	104	4	S26220.0XR2.0
20.00	2.50	20	38	104	4	S26220.0XR2.5
20.00	3.00	20	38	104	4	S26220.0XR3.0
20.00	4.00	20	38	104	4	S26220.0XR4.0

S767

- Stopkové frézy s radiusem
- Тороидальные концевые фрезы
- Frezy walcowo-czołowe z promieniem naroża
- Stopkové frézy s rádiusom

S767 ■ 1.1 1.2 1.3 1.4 1.5 2.1 2.2 3.1 3.2 3.3 3.4 4.2 5.2

S767

HM



N

Z 4



$\lambda \neq 10^\circ$



h9



DORMER

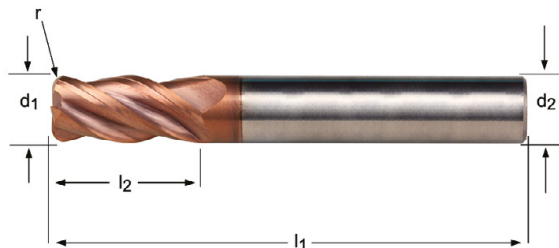

S767



4.00 - 20.00

d_1 \emptyset mm	r ± 0.01 mm	d_2 $\emptyset h_6$ mm	l_2 mm	l_1 mm	z	S767
4.00	0.30	6	11	57	4	S7674.0XR0.3
4.00	0.50	6	11	57	4	S7674.0XR0.5
5.00	0.30	6	13	57	4	S7675.0XR0.3
5.00	0.50	6	13	57	4	S7675.0XR0.5
6.00	0.30	6	13	57	4	S7676.0XR0.3
6.00	0.50	6	13	57	4	S7676.0XR0.5
6.00	1.00	6	13	57	4	S7676.0XR1.0
8.00	0.30	8	20	64	4	S7678.0XR0.3
8.00	0.50	8	20	64	4	S7678.0XR0.5
8.00	1.00	8	20	64	4	S7678.0XR1.0
10.00	0.30	10	22	72	4	S76710.0XR0.3
10.00	0.50	10	22	72	4	S76710.0XR0.5
10.00	1.00	10	22	72	4	S76710.0XR1.0
12.00	0.30	12	26	83	4	S76712.0XR0.3
12.00	0.50	12	26	83	4	S76712.0XR0.5
12.00	1.00	12	26	83	4	S76712.0XR1.0
12.00	2.00	12	26	83	4	S76712.0XR2.0
16.00	0.30	16	32	92	4	S76716.0XR0.3
16.00	0.50	16	32	92	4	S76716.0XR0.5
16.00	1.00	16	32	92	4	S76716.0XR1.0
16.00	2.00	16	32	92	4	S76716.0XR2.0
20.00	0.30	20	38	104	4	S76720.0XR0.3
20.00	0.50	20	38	104	4	S76720.0XR0.5
20.00	1.00	20	38	104	4	S76720.0XR1.0
20.00	2.00	20	38	104	4	S76720.0XR2.0

S536

- Vysokoposuvové frézy
- Концевые фрезы для высоких подач
- Frezy walcowo-czołowe do wysokich posuwów
- Rýchloposuvová fréza (HFC)

S536 ■ 1.7 1.8

S536 **HM** **N** **Z 4-6** **$\lambda 25^\circ$**
 $\gamma 0^\circ$ **DIN 6535HA** **TISIN** **h9** **DORMER**

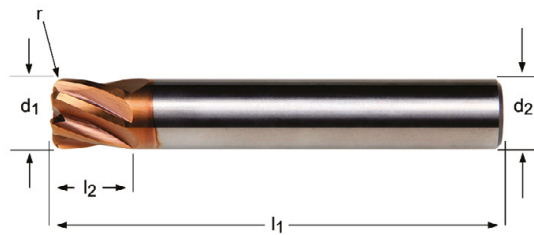





d_1 \varnothing mm	r ± 0.01 mm	d_2 $\varnothing h_6$ mm	l_2 mm	l_1 mm	z	S536
6.00	1.00	6	6	60	4	S5366.0XR1.0
8.00	2.00	8	8	64	6	S5368.0XR2.0
10.00	2.00	10	10	75	6	S53610.0XR2.0
12.00	2.00	12	12	75	6	S53612.0XR2.0

S229

- Kopírovací frézy
- Сферические концевые фрезы
- Frezy kuliste
- Kopírovacie frézy

S229 ■ 1.6 2.3 2.4 4.3 5.3

S229 **HM**  **N** **Z 2**  $\lambda 30^\circ$ $\gamma 3^\circ$ **DIN 6535HA**  **TISIN** **h9**  **DORMER**

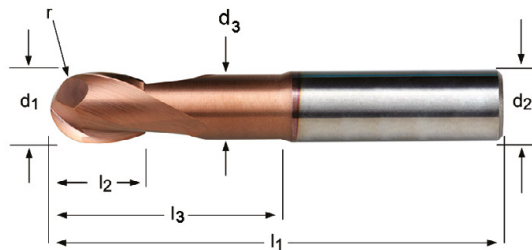

d_1 Ø mm	r +0/-0.02 mm	d_2 Ø _{h6} mm	l_2 mm	l_1 mm	z	l_3 mm	d_3 Ø mm	S229
1.50	0.75	4	3	50	2	6.0	1.4	S2291.5XD4
2.00	1.00	3	4	50	2	8.0	1.9	S2292.0XD3
2.00	1.00	4	4	50	2	8.0	1.9	S2292.0XD4
3.00	1.50	3	5	50	2	14.0	2.8	S2293.0XD3
3.00	1.50	6	5	50	2	14.0	2.8	S2293.0XD6
4.00	2.00	4	8	50	2	20.0	3.7	S2294.0XD4
4.00	2.00	6	8	50	2	20.0	3.7	S2294.0XD6
5.00	2.50	5	9	50	2	20.0	4.6	S2295.0XD5
5.00	2.50	6	9	50	2	20.0	4.6	S2295.0XD6
6.00	3.00	6	10	50	2	20.0	5.5	S2296.0
8.00	4.00	8	12	64	2	30.0	7.4	S2298.0
10.00	5.00	10	14	70	2	32.0	9.2	S22910.0
12.00	6.00	12	16	75	2	38.0	11.0	S22912.0
14.00	7.00	14	32	90	2	44.0	13.0	S22914.0
16.00	8.00	16	32	90	2	46.0	15.0	S22916.0

S231

- Kopirovací frézy
- Сферические концевые фрезы
- Frezy kuliste
- Kopirovacie frézy

S231 ■ 1.6 2.3 2.4 4.3 5.3

S231 **HM** **N** **Z 2** $\lambda 30^\circ$ $\gamma 3^\circ$ **h9**

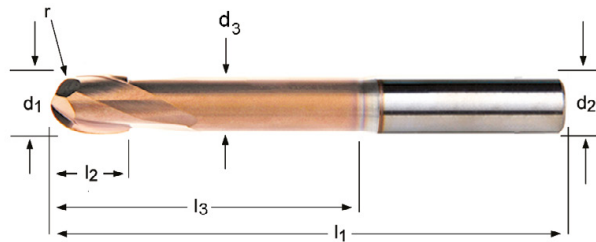

d_1 Ø mm	r +0/-0.02 mm	d_2 Ø _{h6} mm	l_2 mm	l_1 mm	z	l_3 mm	d_3 Ø mm	S231
1.50	0.75	4	3	75	2	10.0	1.4	S2311.5XD4
2.00	1.00	3	4	60	2	14.0	1.9	S2312.0XD3
2.00	1.00	4	4	75	2	14.0	1.9	S2312.0XD4
3.00	1.50	3	5	60	2	21.0	2.8	S2313.0XD3
3.00	1.50	6	5	75	2	21.0	2.8	S2313.0XD6
4.00	2.00	4	8	60	2	28.0	3.7	S2314.0XD4
4.00	2.00	6	8	75	2	28.0	3.7	S2314.0XD6
5.00	2.50	5	9	60	2	32.0	4.6	S2315.0
6.00	3.00	6	10	75	2	40.0	5.5	S2316.0
8.00	4.00	8	10	75	2	40.0	7.4	S2318.0
10.00	5.00	10	12	75	2	40.0	9.2	S23110.0
12.00	6.00	12	16	100	2	60.0	11.0	S23112.0
16.00	8.00	16	32	125	2	80.0	15.0	S23116.0

- S233**
- Kopírovací frézy
 - Сферические концевые фрезы
 - Frezy kuliste
 - Kopírovacie frézy

S233 ■ 1.6 2.3 2.4 4.3 5.3

S233 **HM**  **N** **Z 2**  $\lambda 30^\circ$ $\gamma 3^\circ$ **DIN 6535HA**  **h9**  **DORMER**

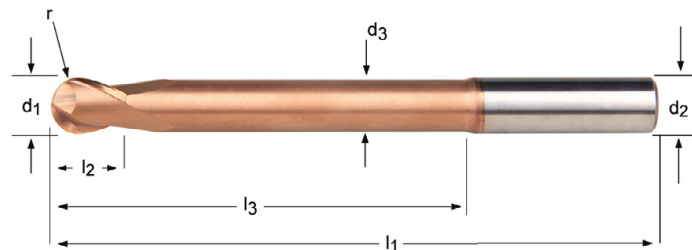

d_1 \varnothing mm	r +0/-0.02 mm	d_2 $\varnothing h_6$ mm	l_2 mm	l_1 mm	z	l_3 mm	d_3 \varnothing mm	S233
2.00	1.00	3	4	100	2	20.0	1.9	S2332.0XD3
2.00	1.00	4	4	100	2	20.0	1.9	S2332.0XD4
3.00	1.50	3	5	100	2	30.0	2.8	S2333.0XD3
3.00	1.50	6	5	100	2	30.0	2.8	S2333.0XD6
4.00	2.00	4	8	100	2	40.0	3.7	S2334.0XD4
4.00	2.00	6	8	100	2	40.0	3.7	S2334.0XD6
5.00	2.50	5	9	100	2	50.0	4.6	S2335.0
6.00	3.00	6	10	100	2	60.0	5.5	S2336.0
8.00	4.00	8	12	100	2	60.0	7.4	S2338.0
10.00	5.00	10	14	125	2	85.0	9.2	S23310.0
12.00	6.00	12	16	125	2	85.0	11.0	S23312.0
14.00	7.00	14	32	150	2	110.0	13.0	S23314.0
16.00	8.00	16	32	150	2	110.0	15.0	S23316.0

S529

- Kopírovací frézy
- Сферические концевые фрезы
- Frezy kuliste
- Kopírovacie frézy

S529 ■ 1.7 1.8

S529 **HM** **N** **Z 2** **$\lambda 30^\circ$**
 $\gamma -10^\circ$ **TISIN** **h9**

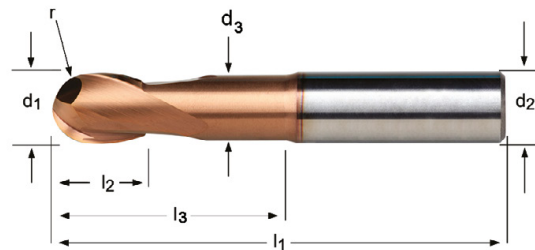

d_1 \emptyset mm	r +0/-0.02 mm	d_2 $\emptyset h_6$ mm	l_2 mm	l_1 mm	z	l_3 mm	d_3 \emptyset mm	S529
1.50	0.75	6	3	50	2	6.0	1.4	S5291.5
2.00	1.00	4	4	50	2	8.0	1.9	S5292.0XD4
2.00	1.00	6	4	50	2	8.0	1.9	S5292.0XD6
3.00	1.50	3	5	50	2	14.0	2.8	S5293.0XD3
3.00	1.50	6	5	50	2	14.0	2.8	S5293.0XD6
4.00	2.00	4	8	50	2	20.0	3.7	S5294.0XD4
4.00	2.00	6	8	50	2	20.0	3.7	S5294.0XD6
5.00	2.50	5	9	50	2	20.0	4.6	S5295.0XD5
5.00	2.50	6	9	50	2	20.0	4.6	S5295.0XD6
6.00	3.00	6	10	50	2	20.0	5.5	S5296.0
8.00	4.00	8	12	64	2	30.0	7.4	S5298.0
10.00	5.00	10	14	70	2	32.0	9.2	S52910.0
12.00	6.00	12	16	75	2	38.0	11.0	S52912.0
16.00	8.00	16	32	90	2	46.0	15.0	S52916.0

S531

- Kopírovací frézy
- Сферические концевые фрезы
- Frezy kuliste
- Kopírovacie frézy

S531 ■ 1.7 1.8

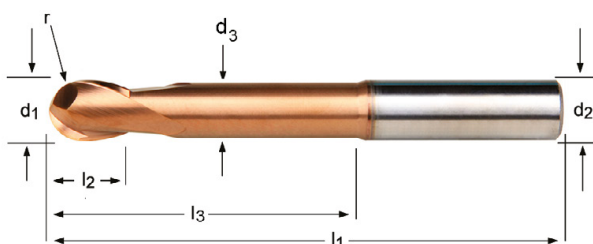
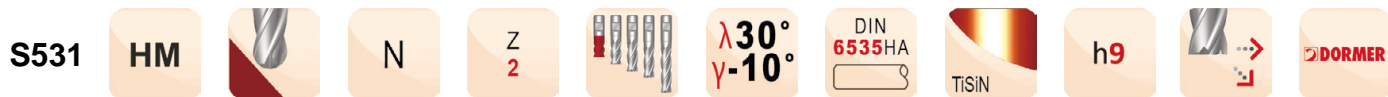

d_1 Ø mm	r +0/-0.02 mm	d_2 Øh ₆ mm	l_2 mm	l_1 mm	z	l_3 mm	d_3 Ø mm	S531
1.50	0.75	6	3	75	2	10.0	1.4	S5311.5
2.00	1.00	4	4	75	2	14.0	1.9	S5312.0XD4
2.00	1.00	6	4	75	2	14.0	1.9	S5312.0XD6
3.00	1.50	3	5	60	2	21.0	2.8	S5313.0XD3
3.00	1.50	6	5	75	2	21.0	2.8	S5313.0XD6
4.00	2.00	4	8	60	2	28.0	3.7	S5314.0XD4
4.00	2.00	6	8	75	2	28.0	3.7	S5314.0XD6
5.00	2.50	5	9	60	2	32.0	4.6	S5315.0XD5
5.00	2.50	6	9	75	2	32.0	4.6	S5315.0XD6
6.00	3.00	6	10	75	2	40.0	5.5	S5316.0
8.00	4.00	8	12	75	2	40.0	7.4	S5318.0
10.00	5.00	10	14	75	2	40.0	9.2	S53110.0
12.00	6.00	12	16	100	2	60.0	11.0	S53112.0
16.00	8.00	16	32	125	2	80.0	15.0	S53116.0

S533

- Kopirovací frézy
- Сферические концевые фрезы
- Frezy kuliste
- Kopirovacie frézy

S533 ■ 1.7 1.8

S533 **HM** **N** **Z 2** **$\lambda 30^\circ$**
 $\gamma -10^\circ$ **DIN 6535HA** **TISIN** **h9** **DORMER**

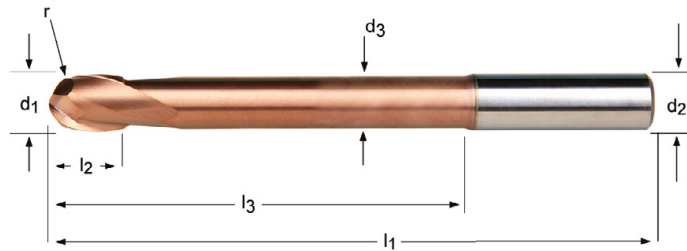

d_1 Ø mm	r +0/-0.02 mm	d_2 Ø mm	l_2 mm	l_1 mm	z	l_3 mm	d_3 Ø mm	S533
2.00	1.00	4	4	100	2	20.0	1.9	S5332.0XD4
2.00	1.00	6	4	100	2	20.0	1.9	S5332.0XD6
3.00	1.50	4	5	100	2	30.0	2.8	S5333.0XD4
3.00	1.50	6	5	100	2	30.0	2.8	S5333.0XD6
4.00	2.00	4	8	100	2	40.0	3.7	S5334.0XD4
4.00	2.00	6	8	100	2	40.0	3.7	S5334.0XD6
5.00	2.50	5	9	100	2	50.0	4.6	S5335.0XD5
5.00	2.50	6	9	100	2	50.0	4.6	S5335.0XD6
6.00	3.00	6	10	100	2	60.0	5.5	S5336.0
8.00	4.00	8	12	100	2	60.0	7.4	S5338.0
10.00	5.00	10	14	125	2	85.0	9.2	S53310.0
12.00	6.00	12	16	125	2	85.0	11.0	S53312.0
14.00	7.00	14	32	150	2	110.0	13.0	S53314.0
16.00	8.00	16	32	150	2	110.0	15.0	S53316.0

S501

- Kopírovací frézy
- Сферические концевые фрезы
- Frezy kuliste
- Kopírovacie frézy

S501	▪	1.1	1.2	1.3	1.4	1.5	1.6	2.1	2.2	2.3	3.1	3.2	3.3	3.4	4.1	4.2	4.3	5.1	5.2	5.3	6.1	
		6.2	6.3	6.4	7.1	7.2	7.3	7.4	8.1	8.2	8.3	9.1										
	•	1.7																				

S501

HM



N

Z
2



λ 30°
 γ 10°

DIN 6535HA

X-CEED

h9



DORMER

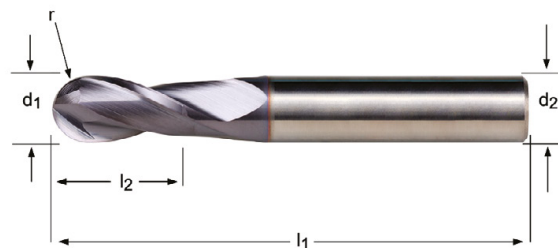

d_1 Ø mm	r ±0.01 mm	d_2 Ø _{h6} mm	l_2 mm	l_1 mm	z	S501
1.00	0.50	3	3	38	2	S5011.0
1.50	0.75	3	3	38	2	S5011.5
2.00	1.00	3	6	38	2	S5012.0
2.50	1.25	3	7	38	2	S5012.5
3.00	1.50	3	7	38	2	S5013.0
4.00	2.00	6	8	57	2	S5014.0
5.00	2.50	6	10	57	2	S5015.0
6.00	3.00	6	10	57	2	S5016.0
7.00	3.50	8	13	63	2	S5017.0
8.00	4.00	8	16	63	2	S5018.0
9.00	4.50	10	16	72	2	S5019.0
10.00	5.00	10	19	72	2	S50110.0
12.00	6.00	12	22	83	2	S50112.0
16.00	8.00	16	26	92	2	S50116.0

S534

- Kopírovací frézy
- Сферические концевые фрезы
- Frezy kuliste
- Kopírovacie frézy

S534 ■ 1.7 1.8

S534 **HM** **N** **Z 4** **$\lambda 30^\circ$**
 $\gamma -10^\circ$ **DIN 6535HA** **TISIN** **h9**

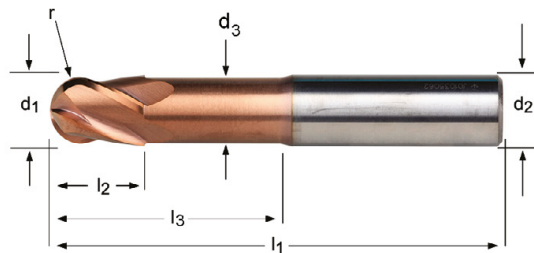

d_1 \varnothing mm	r +0/-0.02 mm	d_2 $\varnothing h_6$ mm	l_2 mm	l_1 mm	z	l_3 mm	d_3 \varnothing mm	S534
3.00	1.50	6	5	50	4	14.0	2.8	S5343.0
4.00	2.00	6	8	50	4	20.0	3.7	S5344.0
5.00	2.50	6	9	50	4	20.0	4.6	S5345.0
6.00	3.00	6	10	50	4	20.0	5.5	S5346.0
8.00	4.00	8	12	64	4	30.0	7.4	S5348.0
10.00	5.00	10	14	70	4	32.0	9.2	S53410.0
12.00	6.00	12	16	75	4	38.0	11.0	S53412.0
14.00	7.00	14	32	90	4	44.0	13.0	S53414.0
16.00	8.00	16	32	90	4	46.0	15.0	S53416.0

S535

- Kopřovací frézy
- Сферические концевые фрезы
- Frezy kuliste
- Kopřovacie frézy

S535 ■ 1.7 1.8

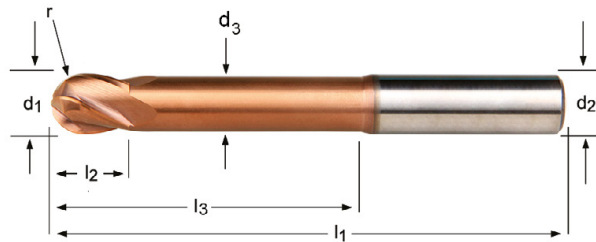

d_1 Ø mm	r +0/-0.02 mm	d_2 Ø _{h6} mm	l_2 mm	l_1 mm	z	l_3 mm	d_3 Ø mm	S535
3.00	1.50	6	5	75	4	21.0	2.8	S5353.0
4.00	2.00	6	8	75	4	28.0	3.7	S5354.0
5.00	2.50	6	9	75	4	32.0	4.6	S5355.0
6.00	3.00	6	10	75	4	40.0	5.5	S5356.0
8.00	4.00	8	12	75	4	40.0	7.4	S5358.0
10.00	5.00	10	14	75	4	40.0	9.2	S53510.0
12.00	6.00	12	16	100	4	60.0	11.0	S53512.0
14.00	7.00	14	32	125	4	80.0	13.0	S53514.0
16.00	8.00	16	32	125	4	80.0	15.0	S53516.0

S511

- Kopírovací frézy
- Сферические концевые фрезы
- Frezy kuliste
- Kopirovacie frézy

S511	▪	1.1	1.2	1.3	1.4	1.5	1.6	2.1	2.2	2.3	3.1	3.2	3.3	3.4	4.1	4.2	4.3	5.1	5.2	5.3	7.3		
		7.4	8.2	8.3	9.1																		
		•	1.7	6.1	6.2	6.3	6.4	7.1	7.2	8.1													

S511	HM		N	Z 4		$\lambda 30^\circ$ $\gamma 10^\circ$	DIN 6535HA	X-CCEED	h9	
------	----	--	---	--------	--	---	---------------	---------	----	--

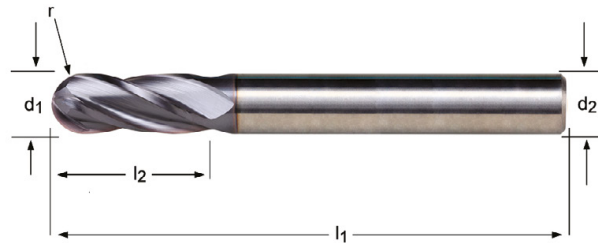

d_1 \varnothing mm	r ± 0.01 mm	d_2 $\varnothing h_6$ mm	l_2 mm	l_1 mm	z	S511
3.00	1.50	6	8	80	4	S5113.0
4.00	2.00	6	11	80	4	S5114.0
5.00	2.50	6	13	80	4	S5115.0
6.00	3.00	6	13	80	4	S5116.0
7.00	3.50	8	16	100	4	S5117.0
8.00	4.00	8	19	100	4	S5118.0
9.00	4.50	10	19	100	4	S5119.0
10.00	5.00	10	22	100	4	S51110.0
12.00	6.00	12	26	100	4	S51112.0
16.00	8.00	16	32	100	4	S51116.0

S629

- Kopírovací frézy
- Сферические концевые фрезы
- Frezy kuliste
- Kopírovacie frézy

S629 ■ 6.1 6.2 6.3 6.4 7.1 7.2 7.3 7.4 8.1 8.2

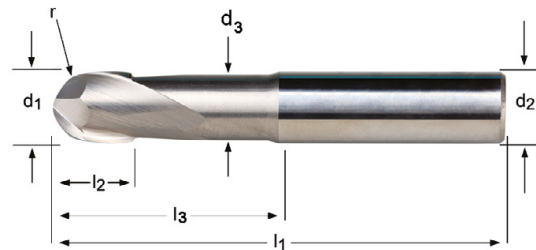

S629



3.00 - 20.00

d_1 ∅ mm	r +0/-0.02 mm	d_2 ∅ mm	l_2 mm	l_1 mm	z	l_3 mm	d_3 ∅ mm	S629
3.00	1.50	6	5	57	2	20.0	2.8	S6293.0
4.00	2.00	6	6	57	2	20.0	3.7	S6294.0
5.00	2.50	6	7	57	2	20.0	4.6	S6295.0
6.00	3.00	6	8	57	2	20.0	5.5	S6296.0
8.00	4.00	8	10	64	2	25.0	7.4	S6298.0
10.00	5.00	10	12	75	2	35.0	9.2	S62910.0
12.00	6.00	12	14	75	2	35.0	11.0	S62912.0
16.00	8.00	16	18	90	2	45.0	15.0	S62916.0
20.00	10.00	20	22	100	2	50.0	19.0	S62920.0

- S739**
- Srážecí frézy - 60°
 - Фасочные концевые фрезы - 60°
 - Frezy walcowo-czołowe do fazowania - 60°
 - Frézy na zrážanie hrán - 60°

- S740**
- Srážecí frézy - 90°
 - Фасочные концевые фрезы - 90°
 - Frezy walcowo-czołowe do fazowania - 90°
 - Frézy na zrážanie hrán - 90°

S739; S740

1.1	1.2	1.3	1.4	1.5	2.1	2.2	3.1	3.2	3.3	3.4	4.2	5.2	6.1	6.2	6.3	6.4
7.1	7.2	7.3	7.4													

S739	HM		N	Z 2		$\lambda 40^\circ$ $\gamma 10^\circ$	DIN 6535HA	AITIN	h9		
S740	HM		N	Z 2		$\lambda 40^\circ$ $\gamma 10^\circ$	DIN 6535HA	AITIN	h9		

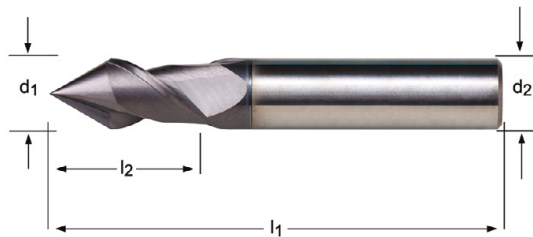

	d ₁ Ø mm	d ₂ Øh ₆ mm	l ₂ mm	l ₁ mm	z	S739	S740
60°	3.00	3	9	40	2	S7393.0	
90°	3.00	3	9	40	2		S7403.0
60°	4.00	4	12	50	2	S7394.0	
90°	4.00	4	12	50	2		S7404.0
60°	5.00	5	15	50	2	S7395.0	
90°	5.00	5	15	50	2		S7405.0
60°	6.00	6	16	50	2	S7396.0	
90°	6.00	6	16	50	2		S7406.0
60°	8.00	8	20	64	2	S7398.0	
90°	8.00	8	20	64	2		S7408.0
60°	10.00	10	22	70	2	S73910.0	
90°	10.00	10	22	70	2		S74010.0
60°	12.00	12	25	75	2	S73912.0	
90°	12.00	12	25	75	2		S74012.0
60°	16.00	16	32	90	2	S73916.0	
90°	16.00	16	32	90	2		S74016.0
60°	20.00	20	38	100	2	S73920.0	
90°	20.00	20	38	100	2		S74020.0

S991

- Sada karbidových fréz
- Набор твердосплавных фрез
- Zestaw frezów węglkowych
- Karbidové frézy, sada

A=typy v sadě, B=počet v sadě, C=rozměry v sadě

A=тип фрез в наборе, B=кол-во фрез, C=диаметры фрез

A=Типы в комплекті. B=Ілосць в комплекті. C=Średnice występujacy w комплекті

A=typy v sade, B=počet v sade, C=rozmary v sade



Nr.	A	B	C	S991
922	S922	6	Ø 3.00 mm, 4.00 mm, 5.00 mm, 6.00 mm, 8.00 mm, 10.00 mm	S991SET922
933	S933	6	Ø 3.00 mm, 4.00 mm, 5.00 mm, 6.00 mm, 8.00 mm, 10.00 mm	S991SET933
944	S944	6	Ø 3.00 mm, 4.00 mm, 5.00 mm, 6.00 mm, 8.00 mm, 10.00 mm	S991SET944

- C110** • Drážkovací frézy
• Фрезы для обработки пазов
- C126** • Frezy palcowe do rowków na wpusty
• Drážkovacie frézy

C110	▪	1.1	1.2	4.1	5.1	6.1	6.2	6.3								
	•	1.3	1.4	2.1	3.1	3.2	3.3	3.4	4.2	5.2	7.1	7.2	7.3	8.1		
C126	▪	1.1	1.2	1.3	1.4	3.1	3.2	3.3	3.4	4.1	4.2	5.1	5.2	6.1	6.2	6.3
	•	1.5	1.6	2.1	2.3	4.3	5.3	6.4	7.1	7.2	7.3	7.4	8.1			

C110	HSS-E PM		N	Z 2		$\lambda 30^\circ$ $\gamma 12^\circ$	DIN 1835B		e8		DIN 327D
C126	HSS-E PM		N	Z 2		$\lambda 30^\circ$ $\gamma 12^\circ$	DIN 1835B	TiCN	e8		DIN 327D

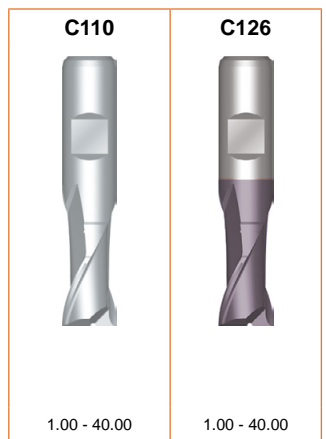
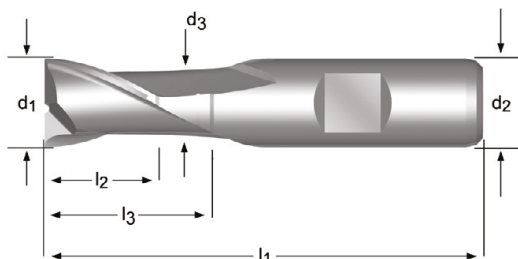

d ₁ Ø Inch	d ₁ Ø mm	d ₂ Øh ₆ mm	l ₂ mm	l ₁ mm	z	l ₃ mm	d ₃ Ø mm	C110	C126
	1.00	6	2.5	47	2	-	-	C1101.0	C1261.0
	1.50	6	3	47	2	-	-	C1101.5	C1261.5
1/16	1.59	6	3	47	2	-	-	C1101/16	
	1.80	6	4	48	2	-	-	C1101.8	
	2.00	6	4	48	2	-	-	C1102.0	C1262.0
3/32	2.38	6	5	49	2	-	-	C1103/32	
	2.50	6	5	49	2	-	-	C1102.5	C1262.5
	2.80	6	5	49	2	-	-	C1102.8	
1/8	3.00	6	5	49	2	-	-	C1103.0	C1263.0
	3.18	6	6	50	2	-	-	C1101/8	
	3.50	6	6	50	2	-	-	C1103.5	C1263.5
	3.80	6	7	51	2	-	-	C1103.8	
	4.00	6	7	51	2	-	-	C1104.0	C1264.0
	4.50	6	7	51	2	-	-	C1104.5	C1264.5
3/16	4.76	6	8	52	2	-	-	C1103/16	
	4.80	6	8	52	2	-	-	C1104.8	¹⁾²⁾
	5.00	6	8	52	2	-	-	C1105.0	C1265.0
	5.50	6	8	52	2	-	-	C1105.5	C1265.5
	5.75	6	8	52	2	-	-	C1105.75	¹⁾²⁾
1/4	6.00	6	8	52	2	-	-	C1106.0	C1266.0
	6.35	10	10	60	2	-	-	C1101/4	
	6.50	10	10	60	2	-	-	C1106.5	C1266.5
	7.00	10	10	60	2	-	-	C1107.0	C1267.0
	7.50	10	10	60	2	-	-	C1107.5	C1267.5
	7.75	10	11	61	2	-	-	C1107.75	¹⁾²⁾
5/16	7.94	10	11	61	2	-	-	C1105/16	
	8.00	10	11	61	2	-	-	C1108.0	C1268.0

¹⁾ tolerance průměru h10 / допуск на диаметр h10 / Tolerancja średnicy h10 / tolerancja piemeru h10
²⁾ ≠ P9 tolerance / Обработка пазов с допуском P9 / ≠ P9 Tolerancja / ≠ P9 tolerancja

d_1 Ø Inch	d_1 Ø mm	d_2 Ø _{h₆} mm	l_2 mm	l_1 mm	z	l_3 mm	d_3 Ø mm	C110	C126
	8.50	10	11	61	2	-	-	C1108.5	C1268.5
	9.00	10	11	61	2	-	-	C1109.0	C1269.0
	9.50	10	11	61	2	-	-	C1109.5	C1269.5
3/8	9.52	10	13	63	2	22.5	9.5	C1103/8	
	10.00	10	13	63	2	22.5	9.5	C11010.0	C12610.0
13/32	10.32	12	13	70	2	-	-	C11013/32	
	10.50	12	13	70	2	-	-	C11010.5	C12610.5
	11.00	12	13	70	2	-	-	C11011.0	C12611.0
7/16	11.11	12	13	70	2	-	-	C1107/16	
	11.50	12	13	70	2	-	-	C11011.5	C12611.5
	12.00	12	16	73	2	27.5	11.5	C11012.0	C12612.0
	12.50	12	16	73	2	27.5	11.5	C11012.5	C12612.5
1/2	12.70	12	16	73	2	27.5	11.5	C1101/2	
	13.00	12	16	73	2	27.5	11.5	C11013.0	C12613.0
17/32	13.49	12	16	73	2	27.5	11.5	C11017/32	
	14.00	12	16	73	2	27.5	11.5	C11014.0	C12614.0
9/16	14.29	12	16	73	2	27.5	11.5	C1109/16	
	15.00	12	16	73	2	27.5	11.5	C11015.0	C12615.0
5/8	15.88	16	19	79	2	30.5	15.5	C1105/8	
	16.00	16	19	79	2	30.5	15.5	C11016.0	C12616.0
	17.00	16	19	79	2	30.5	15.5	C11017.0	
11/16	17.46	16	19	79	2	30.5	15.5	C11011/16	
	18.00	16	19	79	2	30.5	15.5	C11018.0	C12618.0
	19.00	16	19	79	2	30.5	15.5	C11019.0	
3/4	19.05	20	22	88	2	37.5	18.5	C1103/4	
	20.00	20	22	88	2	37.5	19.5	C11020.0	C12620.0
	22.00	20	22	88	2	37.5	19.5	C11022.0	C12622.0
7/8	22.22	20	22	88	2	37.5	19.5	C1107/8	
	24.00	25	26	102	2	45.5	23.5	C11024.0	C12624.0
	25.00	25	26	102	2	45.5	24.5	C11025.0	C12625.0
1"	25.40	25	26	102	2	45.5	24.5	C1101	
	26.00	25	26	102	2	45.5	24.5	C11026.0	
	28.00	25	26	102	2	45.5	24.5	C11028.0	
	30.00	25	26	102	2	45.5	24.5	C11030.0	C12630.0
	32.00	32	32	112	2	51.5	31.5	C11032.0	
	35.00	32	32	112	2	51.5	31.5	C11035.0	¹⁾³⁾
	36.00	32	32	112	2	51.5	31.5	C11036.0	¹⁾³⁾
	40.00	40	38	130	2	59.5	39.0	C11040.0	¹⁾³⁾

¹⁾ tolerance průměru h10 / допуск на диаметр h10 / Tolerancja średnicy h10 / tolerancia piemeru h10

²⁾ ≠ P9 tolerance / Обработка пазов с допуском P9 / ≠ P9 Tolerancja / ≠ P9 tolerancia

³⁾ Pouze HSCo. / Заказ только в исполнении из быстрорежущей стали / Dostępne tylko jako HSCo / Iba HSS-Co

- C123** • Drážkovací frézy
• Фрезы для обработки пазов
- C139** • Frezy palcowe do rowków na wpusty
• Drážkovacie frézy

C123	▪	1.1	1.2	1.3	1.4	4.1	5.1	6.1	6.2	6.3						
	•	2.1	3.1	3.2	3.3	3.4	4.2	5.2	7.1	7.2	7.3	8.1				
C139	▪	1.1	1.2	1.3	1.4	3.1	3.2	3.3	3.4	4.1	4.2	5.1	5.2	6.1	6.2	6.3
	•	1.5	1.6	2.1	2.3	4.3	5.3	6.4	7.1	7.2	7.3	7.4	8.1			

C123	HSS-E PM		N	Z 2		$\lambda 30^\circ$ $\gamma 12^\circ$	DIN 1835B		e8		DIN 844K
C139	HSS-E PM		N	Z 2		$\lambda 30^\circ$ $\gamma 12^\circ$	DIN 1835B	TiCN	e8		DIN 844K

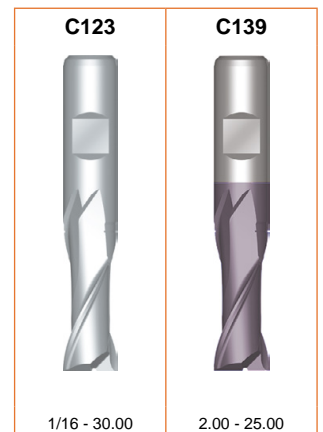
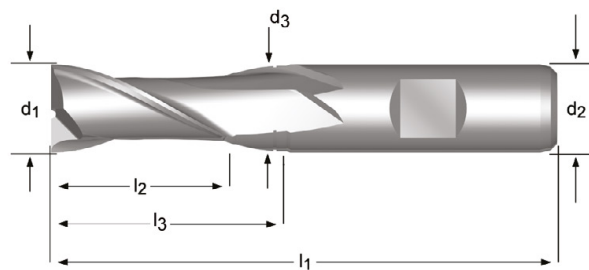

d ₁ Ø Inch	d ₁ Ø mm	d ₂ Ø _{h₆} mm	l ₂ mm	l ₁ mm	z	l ₃ mm	d ₃ Ø mm	C123	C139
1/16	1.59	6	7	51	2	-	-	C1231/16	¹⁾
	2.00	6	7	51	2	-	-	C1232.0	C1392.0
	2.50	6	8	52	2	-	-	C1232.5	
1/8	3.00	6	8	52	2	-	-	C1233.0	C1393.0
	3.18	6	10	54	2	-	-	C1231/8	¹⁾
	3.50	6	10	54	2	-	-	C1233.5	
5/32	3.97	6	11	55	2	-	-	C1235/32	¹⁾
	4.00	6	11	55	2	-	-	C1234.0	C1394.0
	4.50	6	11	55	2	-	-	C1234.5	
3/16	4.76	6	13	57	2	-	-	C1233/16	¹⁾
	5.00	6	13	57	2	-	-	C1235.0	C1395.0
	5.50	6	13	57	2	-	-	C1235.5	C1395.5
1/4	6.00	6	13	57	2	-	-	C1236.0	C1396.0
	6.35	10	16	66	2	-	-	C1231/4	¹⁾
	6.50	10	16	66	2	-	-	C1236.5	C1396.5
5/16	7.00	10	16	66	2	-	-	C1237.0	C1397.0
	7.50	10	16	66	2	-	-	C1237.5	C1397.5
	7.94	10	19	69	2	-	-	C1235/16	¹⁾
3/8	8.00	10	19	69	2	-	-	C1238.0	C1398.0
	8.50	10	19	69	2	-	-	C1238.5	C1398.5
	9.00	10	19	69	2	-	-	C1239.0	C1399.0
1/2	9.50	10	19	69	2	-	-	C1239.5	C1399.5
	9.52	10	22	72	2	31.5	9.5	C1233/8	¹⁾
	10.00	10	22	72	2	31.5	9.5	C12310.0	C13910.0
1/2	11.00	12	22	79	2	-	-	C12311.0	C13911.0
	12.00	12	26	83	2	37.5	11.5	C12312.0	C13912.0
	12.70	12	26	83	2	37.5	11.5	C1231/2	¹⁾
	13.00	12	26	83	2	37.5	11.5	C12313.0	C13913.0

d_1 Ø Inch	d_1 Ø mm	d_2 Ø _{h₆} mm	l_2 mm	l_1 mm	z	l_3 mm	d_3 Ø mm	C123	C139
	14.00	12	26	83	2	37.5	11.5	C12314.0	C13914.0
	15.00	12	26	83	2	37.5	11.5	C12315.0	C13915.0
	16.00	16	32	92	2	43.5	15.5	C12316.0	C13916.0
	18.00	16	32	92	2	43.5	15.5	C12318.0	C13918.0
	20.00	20	38	104	2	53.5	19.5	C12320.0	C13920.0
	22.00	20	38	104	2	53.5	19.5	C12322.0	C13922.0
	25.00	25	45	121	2	64.5	24.5	C12325.0	C13925.0
	30.00	25	45	121	2	64.5	24.5	C12330.0	

¹⁾ tolerance průměru - .0005" / -.0013" / допуск на диаметр -0.0005 дюйма / -0.0013 дюйма / Tolerancja średnicy -.0005 cala/ -.0013 cala / tolerancja priemeru - .0005" / -.0013"

²⁾ tolerance průměru - .0005" / -.0015" / допуск на диаметр -0.0005 дюйма / -0.0015 дюйма / tolerancja średnicy-.0005 cala/ -.0015 cala / tolerancja priemeru - .0005" / -.0015"

³⁾ Pouze HSCo. / Заказ только в исполнении из быстрорежущей стали / Dostępne tylko jako HSCo / Iba HSS-Co

C135

- Drážkovací frézy
- Фрезы для обработки пазов
- Frezy palcowe do rowków na wpusty
- Drážkovacie frézy

C135 ■ 1.1 1.2 5.1 6.1 6.2 6.3
 • 1.3 1.4 2.1 3.1 3.2 3.3 3.4 4.1 4.2 5.2 7.1 7.2 7.3 8.1

C135 HSS-E P9 N Z 2 λ 30° γ 12° DIN 1835B e8 DORMER

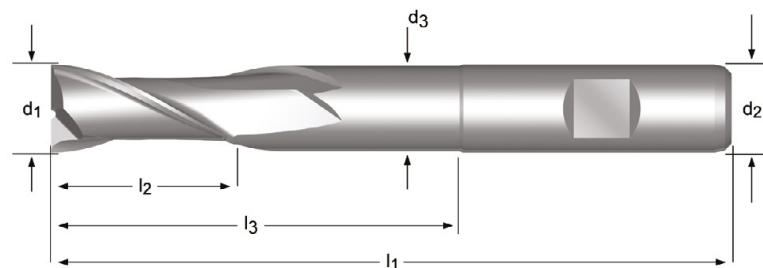

d_1 Ø mm	d_2 Ø _{h6} mm	l_2 mm	l_1 mm	z	l_3 mm	d_3 Ø mm	C135
2.00	6	7	54	2	18.0	1.8	C1352.0
3.00	6	8	56	2	20.0	2.8	C1353.0
4.00	6	11	63	2	27.0	3.7	C1354.0
5.00	6	13	68	2	32.0	4.7	C1355.0
6.00	6	13	68	2	32.0	5.7	C1356.0
8.00	10	19	88	2	48.0	7.5	C1358.0
10.00	10	22	95	2	54.5	9.5	C13510.0
12.00	12	26	110	2	64.5	11.5	C13512.0
14.00	12	26	110	2	64.5	11.5	C13514.0
16.00	16	32	123	2	74.5	15.5	C13516.0
18.00	16	32	123	2	74.5	15.5	C13518.0
20.00	20	38	141	2	90.5	19.5	C13520.0

C306 • Drážkovací frézy
• Фрезы для обработки пазов

C353 • Frezy palcowe do rowków na wpusty
• Drážkovacie frézy

C306	▪	1.2	1.3	4.1	5.1	6.1	6.2	6.3											
	•	1.1	1.4	2.1	3.1	3.2	3.3	3.4	4.2	5.2	7.2	7.3	8.1						
C353	▪	1.2	1.3	1.4	1.5	3.1	3.2	3.3	3.4	4.1	4.2	5.1	5.2	6.1	6.2	6.3			
	•	1.1	1.6	2.1	2.2	2.3	4.3	5.3	6.4	7.2	7.3	7.4	8.1						

C306	HSS-E PM		N	Z 3		$\lambda 30^\circ$ $\gamma 12^\circ$	DIN 1835B		e8 h10		DIN 327D
C353	HSS-E PM		N	Z 3		$\lambda 30^\circ$ $\gamma 12^\circ$	DIN 1835B	Alcrona	e8 h10		DIN 327D

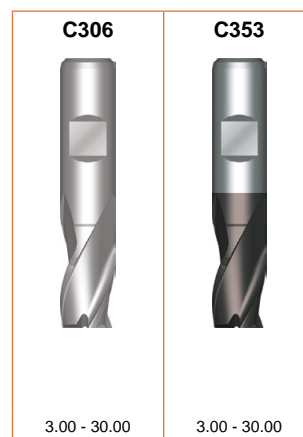
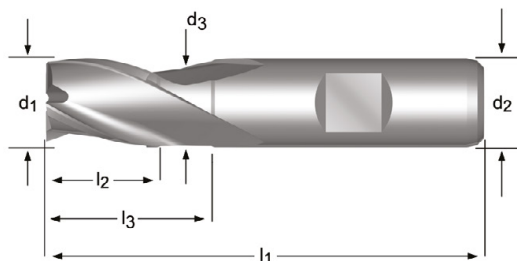

d_1 \varnothing mm	d_2 $\varnothing h_6$ mm	l_2 mm	l_1 mm	z	l_3 mm	d_3 \varnothing mm	C306	C353
3.00	6	5	49	3	-	-	C3063.0	C3533.0
3.50	6	6	50	3	-	-	-	C3533.5
4.00	6	7	51	3	-	-	C3064.0	C3534.0
4.50	6	7	51	3	-	-	-	C3534.5
4.80	6	8	52	3	-	-	-	C3534.8
5.00	6	8	52	3	-	-	C3065.0	C3535.0
5.50	6	8	52	3	-	-	-	C3535.5
6.00	6	8	52	3	-	-	C3066.0	C3536.0
6.50	10	10	60	3	-	-	-	C3536.5
7.00	10	10	60	3	-	-	C3067.0	C3537.0
7.50	10	10	60	3	-	-	-	C3537.5
7.75	10	11	61	3	-	-	-	C3537.75
8.00	10	11	61	3	-	-	C3068.0	C3538.0
8.50	10	11	61	3	-	-	-	C3538.5
9.00	10	11	61	3	-	-	C3069.0	C3539.0
9.50	10	11	61	3	-	-	C3069.5	C3539.5
10.00	10	13	63	3	22.5	9.5	C30610.0	C35310.0
11.00	12	13	70	3	-	-	C30611.0	C35311.0
12.00	12	16	73	3	27.5	11.5	C30612.0	C35312.0
13.00	12	16	73	3	27.5	11.5	-	C35313.0
14.00	12	16	73	3	27.5	11.5	C30614.0	C35314.0
15.00	12	16	73	3	27.5	11.5	C30615.0	C35315.0
16.00	16	19	79	3	30.5	15.5	C30616.0	C35316.0
18.00	16	19	79	3	30.5	15.5	C30618.0	C35318.0
20.00	20	22	88	3	37.5	19.5	C30620.0	C35320.0
22.00	20	22	88	3	37.5	19.5	C30622.0	C35322.0
25.00	25	26	102	3	45.5	24.5	C30625.0	C35325.0
28.00	25	26	102	3	45.5	24.5	-	C35328.0
30.00	25	26	102	3	45.5	24.5	C30630.0	C35330.0

C367

- Drážkovací frézy
- Фрезы для обработки пазов
- Frezy palcowe do rowków na wpusty
- Drážkovacie frézy

C367	▪	1.1	1.2	2.1	2.2	2.3	2.4	6.1	7.1	
	•	1.3	1.4	4.1	5.1	6.2	6.3	7.2	7.3	8.1

C367 **HSS-E PM** **P9** **N** **Z 3** **λ 40°** **γ 15°** **DIN 1835B** **Alcrona** **e8** **DIN 327D**

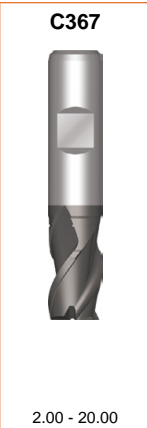
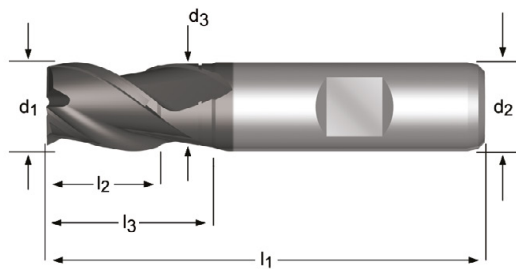

d_1 Ø mm	d_2 Ø mm	l_2 mm	l_1 mm	z	l_3 mm	d_3 Ø mm	C367
2.00	6	4	48	3	-	-	C3672.0
3.00	6	5	49	3	-	-	C3673.0
4.00	6	7	51	3	-	-	C3674.0
5.00	6	8	52	3	-	-	C3675.0
6.00	6	8	52	3	-	-	C3676.0
7.00	10	10	60	3	-	-	C3677.0
8.00	10	11	61	3	-	-	C3678.0
10.00	10	13	63	3	22.5	9.5	C36710.0
11.00	12	13	70	3	-	-	C36711.0
12.00	12	16	73	3	27.5	11.5	C36712.0
14.00	12	16	73	3	27.5	11.5	C36714.0
16.00	16	19	79	3	30.5	15.5	C36716.0
18.00	16	19	79	3	30.5	15.5	C36718.0
20.00	20	22	88	3	37.5	19.5	C36720.0

C305 • Drážkovací frézy
• Фрезы для обработки пазов

C352 • Frezy palcowe do rowków na wpusty
• Drážkovacie frézy

C305	▪	1.2	1.3	4.1	5.1	5.2	6.1	6.2	6.3							
	•	1.1	1.4	2.1	3.1	3.2	3.3	3.4	4.2	7.2	7.3	8.1				
C352	▪	1.2	1.3	1.4	1.5	3.1	3.2	3.3	3.4	4.1	4.2	5.1	5.2	6.1	6.2	6.3
	•	1.1	1.6	2.1	2.2	2.3	4.3	5.3	6.4	7.2	7.3	7.4	8.1			

C305	HSS-E PM		N	Z 3		λ 30° γ 12°	DIN 1835B		e8		DIN 844K
	HSS-E PM		N	Z 3		λ 30° γ 12°	DIN 1835B	Alcrona	e8		DIN 844K

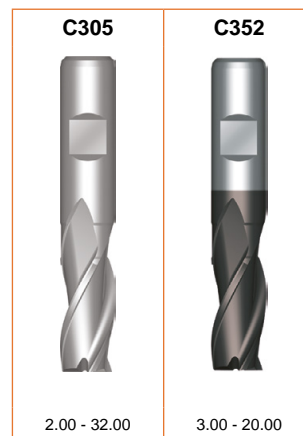
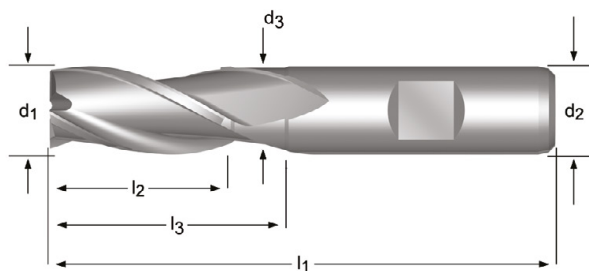

d_1 Ø mm	d_2 Ø _{h6} mm	l_2 mm	l_1 mm	z	l_3 mm	d_3 Ø mm	C305	C352
2.00	6	7	51	3	-	-	C3052.0	
2.50	6	8	52	3	-	-	C3052.5	
3.00	6	8	52	3	-	-	C3053.0	C3523.0
3.50	6	10	54	3	-	-	C3053.5	
4.00	6	11	55	3	-	-	C3054.0	C3524.0
4.50	6	11	55	3	-	-	C3054.5	
5.00	6	13	57	3	-	-	C3055.0	C3525.0
5.50	6	13	57	3	-	-	C3055.5	
6.00	6	13	57	3	-	-	C3056.0	C3526.0
6.50	10	16	66	3	-	-	C3056.5	
7.00	10	16	66	3	-	-	C3057.0	
7.50	10	16	66	3	-	-	C3057.5	
8.00	10	19	69	3	-	-	C3058.0	C3528.0
8.50	10	19	69	3	-	-	C3058.5	
9.00	10	19	69	3	-	-	C3059.0	
10.00	10	22	72	3	31.5	9.5	C30510.0	C35210.0
11.00	12	22	79	3	-	-	C30511.0	
12.00	12	26	83	3	37.5	11.5	C30512.0	C35212.0
13.00	12	26	83	3	37.5	11.5	C30513.0	
14.00	12	26	83	3	37.5	11.5	C30514.0	C35214.0
15.00	12	26	83	3	37.5	11.5	C30515.0	
16.00	16	32	92	3	43.5	15.5	C30516.0	C35216.0
17.00	16	32	92	3	43.5	15.5	C30517.0	
18.00	16	32	92	3	43.5	15.5	C30518.0	C35218.0
19.00	16	32	92	3	43.5	15.5	C30519.0	
20.00	20	38	104	3	53.5	19.5	C30520.0	C35220.0
22.00	20	38	104	3	53.5	19.5	C30522.0	
25.00	25	45	121	3	-	-	C30525.0	
28.00	25	45	121	3	-	-	C30528.0	
30.00	25	45	121	3	-	-	C30530.0	
32.00	32	53	133	3	-	-	C30532.0	

- C159**
- Drážkovací frézy
 - Фрезы для обработки пазов
 - Frezy palcowe do rowków na wpusty
 - Drážkovacie frézy

C159 ■ 1.1 6.1 6.2 6.3 7.1 7.2 7.3 8.1 8.2
 • 1.2 1.3 2.1 2.2 4.1 5.1

C159 HSS-E P9 W Z 2 λ 40° γ 20° DIN 1835B e8 DIN 844K

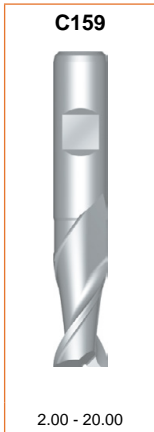
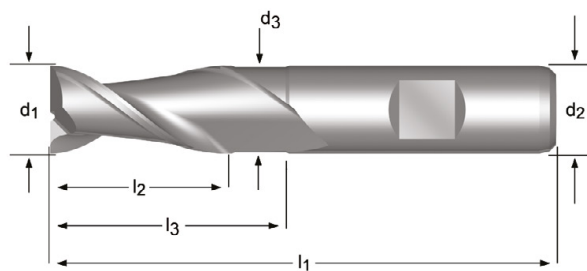

d_1 Ø mm	d_2 Ø _{h6} mm	l_2 mm	l_1 mm	z	l_3 mm	d_3 Ø mm	C159
2.00	6	7	51	2	-	-	C1592.0
3.00	6	8	52	2	-	-	C1593.0
4.00	6	11	55	2	-	-	C1594.0
5.00	6	13	57	2	-	-	C1595.0
6.00	6	13	57	2	-	-	C1596.0
8.00	10	19	69	2	-	-	C1598.0
10.00	10	22	72	2	-	-	C15910.0
12.00	12	26	83	2	-	-	C15912.0
14.00	12	26	83	2	37.5	11.5	C15914.0
16.00	16	32	92	2	43.5	15.5	C15916.0
18.00	16	32	92	2	43.5	15.5	C15918.0
20.00	20	38	104	2	53.5	19.5	C15920.0

C336

- Stopkové frézy
- Концевые фрезы
- Frezy walcowo-czołowe
- Stopkové frézy

C336	▪	6.1	6.2	6.3	7.1	7.2	7.3	8.1	8.2
	•	1.1	1.2	1.3	2.1	2.2	4.1	5.1	

C336 HSS-E PM W Z 3 λ 40° γ 25° DIN 1835B k10 DIN 844K

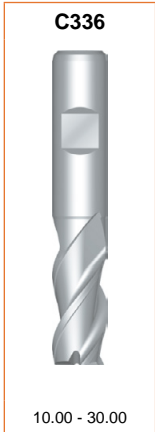
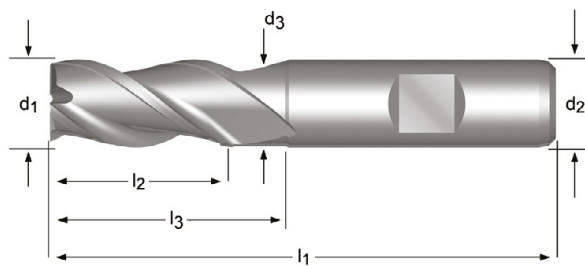

d_1 Ø mm	d_2 Ø _{h6} mm	l_2 mm	l_1 mm	z	l_3 mm	d_3 Ø mm	C336
10.00	10	22	72	3	31.5	9.5	C33610.0
12.00	12	26	83	3	37.5	11.5	C33612.0
14.00	12	26	83	3	37.5	11.5	C33614.0
16.00	16	32	92	3	43.5	15.5	C33616.0
18.00	16	32	92	3	43.5	15.5	C33618.0
20.00	20	38	104	3	53.5	19.5	C33620.0
22.00	20	38	104	3	53.5	19.5	C33622.0
25.00	25	45	121	3	64.5	24.5	C33625.0
30.00	25	45	121	3	64.5	24.5	C33630.0

- C167**
- Stopkové frézy
 - Концевые фрезы
 - Frezy walcowo-czołowe z przedłużoną częścią chwytową
 - Stopkové frézy

C167	▪	1.1	1.2	5.1	6.1	6.2	6.3								
	•	1.3	1.4	2.1	3.1	3.2	3.3	3.4	4.1	4.2	5.2	7.1	7.2	7.3	8.1

C167 HSS-E N Z 2 $\lambda 30^\circ$ $\gamma 12^\circ$ js14

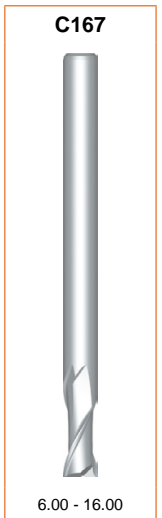
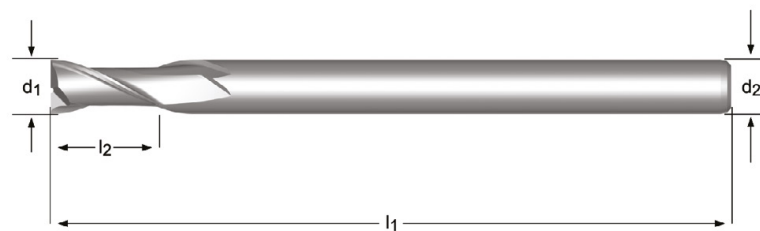

d_1 \emptyset mm	d_2 $\emptyset h_6$ mm	l_2 mm	l_1 mm	z	C167
6.00	6	13	180	2	C1676.0
8.00	8	19	180	2	C1678.0
10.00	10	22	200	2	C16710.0
12.00	12	26	200	2	C16712.0
16.00	16	32	200	2	C16716.0

C122

- Stopkové frézy
- Концевые фрезы
- Frezy walcowo-czołowe
- Stopkové frézy

C122	▪	1.1	1.2	5.1	6.1	6.2	6.3										
	•	1.3	1.4	2.1	3.1	3.2	3.3	3.4	4.1	4.2	5.2	7.1	7.2	7.3	8.1		

C122 HSS-E N Z 2 $\lambda 30^\circ$ $\gamma 12^\circ$ DIN 1835A e8 DORMER

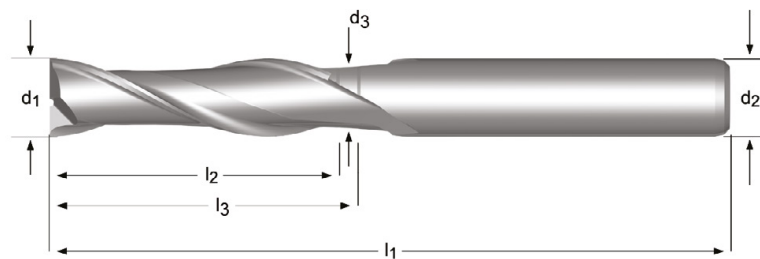

C122



5.00 - 22.00

d_1 Ø mm	d_2 Ø _{h6} mm	l_2 mm	l_1 mm	z	l_3 mm	d_3 Ø mm	C122
5.00	5	22	65	2	-	-	C1225.0
6.00	6	27	75	2	-	-	C1226.0
7.00	8	33	85	2	-	-	C1227.0
8.00	8	33	85	2	-	-	C1228.0
10.00	10	40	95	2	-	-	C12210.0
12.00	12	45	110	2	-	-	C12212.0
14.00	12	52	125	2	-	-	C12214.0
16.00	16	58	140	2	69.5	15.5	C12216.0
18.00	16	65	150	2	76.5	15.5	C12218.0
20.00	20	70	160	2	85.5	19.5	C12220.0
22.00	20	75	170	2	90.5	19.5	C12222.0

C346

- Stopkové frézy
- Концевые фрезы
- Frezy walcowo-czołowe
- Stopkové frézy

C346	▪	1.2	4.1	5.1	6.1	6.2	6.3							
	•	1.1	1.3	1.4	2.1	3.1	3.2	3.3	3.4	4.2	5.2	7.1	7.2	8.1

C346 HSS-E N Z 3 $\lambda 30^\circ$ $\gamma 12^\circ$

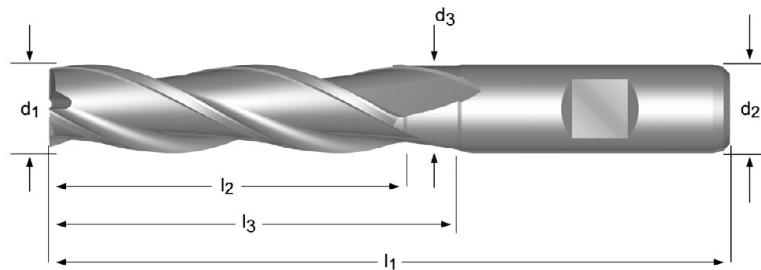

d_1 \emptyset mm	d_2 $\emptyset h_6$ mm	l_2 mm	l_1 mm	z	l_3 mm	d_3 \emptyset mm	C346
3.00	6	12	56	3	-	-	C3463.0
4.00	6	19	63	3	-	-	C3464.0
5.00	6	24	68	3	-	-	C3465.0
6.00	6	24	68	3	-	-	C3466.0
7.00	10	30	80	3	-	-	C3467.0
8.00	10	38	88	3	-	-	C3468.0
9.00	10	38	88	3	-	-	C3469.0
10.00	10	45	95	3	-	-	C34610.0
11.00	12	45	102	3	-	-	C34611.0
12.00	12	53	110	3	-	-	C34612.0
13.00	12	53	110	3	64.5	11.5	C34613.0
15.00	12	53	110	3	64.5	11.5	C34615.0
16.00	16	63	123	3	74.5	15.5	C34616.0
20.00	20	75	141	3	90.5	19.5	C34620.0

C299 • Stopkové frézy
• Концевые фрезы

C907 • Frezy walcowo-czołowe
• Stopkové frézy

C299	▪	1.3	1.4	1.5	2.1	2.3	3.1	3.2	3.3	3.4	4.2	4.3	5.1	5.2	5.3	6.2	7.4		
	•	1.6	2.2	4.1															
C907	▪	1.3	1.4	1.5	1.6	2.1	2.2	2.3	3.1	3.2	3.3	3.4	4.2	4.3	5.1	5.2	5.3	6.2	7.4
	•	4.1																	

C299	HSS-E PM		N	Z 3-5		$\lambda 45^\circ$ $\gamma 12^\circ$	DIN 1835B		k10		DIN 844K
C907	HSS-E PM		N	Z 3-6		$\lambda 45^\circ$ $\gamma 12^\circ$	DIN 1835B	Alcrona	k10		DIN 844K

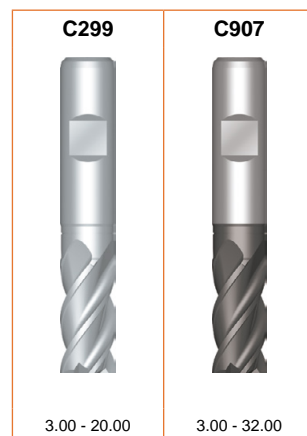
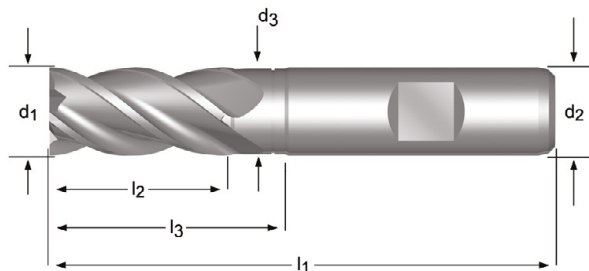

d_1 \emptyset mm	d_2 $\emptyset h_6$ mm	l_2 mm	l_1 mm	z	l_3 mm	d_3 \emptyset mm	C299	C907
3.00	6	8	52	3	-	-	C2993.0	C9073.0
4.00	6	11	55	3	-	-	C2994.0	C9074.0
5.00	6	13	57	3	-	-	C2995.0	C9075.0
6.00	6	13	57	3	-	-	C2996.0	C9076.0
8.00	10	19	69	4	-	-	C2998.0	C9078.0
10.00	10	22	72	4	31.5	9.5	C29910.0	C90710.0
12.00	12	26	83	4	37.5	11.5	C29912.0	C90712.0
14.00	12	26	83	4	37.5	11.5	C29914.0	C90714.0
16.00	16	32	92	4	43.5	15.5	C29916.0	C90716.0
18.00	16	32	92	4	43.5	15.5	C29918.0	C90718.0
20.00	20	38	104	4	53.5	19.5	C29920.0	C90720.0
22.00	20	38	104	5	53.5	19.5		C90722.0
28.00	25	45	121	6	64.5	24.5		C90728.0
30.00	25	45	121	6	64.5	24.5		C90730.0
32.00	32	53	133	6	72.5	31.5		C90732.0

C920

- Stopkové frézy
- Концевые фрезы
- Frezy walcowo-czołowe
- Stopkové frézy

C920 ■ 1.3 1.4 1.5 1.6 2.1 2.2 2.3 3.1 3.2 3.3 3.4 4.2 4.3 5.1 5.2 5.3 6.2 7.4
 • 4.1

C920 HSS-E PM N Z 3-5 $\lambda 45^\circ$ $\gamma 12^\circ$ DIN 1835B Alcrona k10 DIN 844L

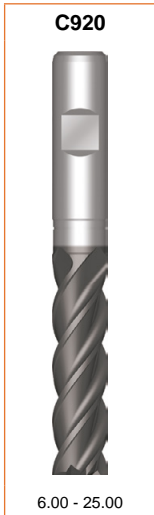
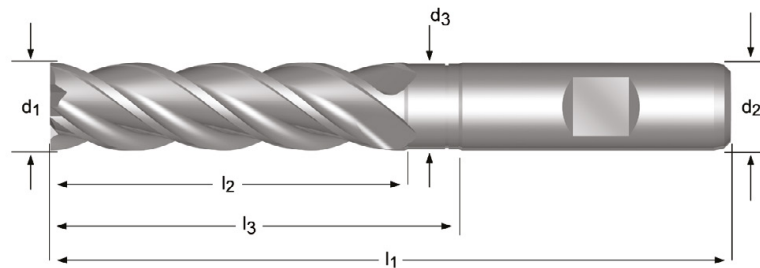

d_1 Ø mm	d_2 Ø _{h6} mm	l_2 mm	l_1 mm	z	l_3 mm	d_3 Ø mm	C920
6.00	6	24	68	3	-	-	C9206.0
8.00	10	38	88	4	-	-	C9208.0
10.00	10	45	95	4	54.5	9.5	C92010.0
12.00	12	53	110	4	64.5	11.5	C92012.0
14.00	12	53	110	4	64.5	11.5	C92014.0
16.00	16	63	123	4	74.5	15.5	C92016.0
18.00	16	63	123	4	74.5	15.5	C92018.0
20.00	20	75	141	4	90.5	19.5	C92020.0
22.00	20	75	141	5	90.5	19.5	C92022.0
25.00	25	90	166	5	109.5	24.5	C92025.0

C247 • Stopkové frézy
• Концевые фрезы

C246 • Frezy walcowo-czołowe
• Stopkové frézy

C247	▪	1.1	1.2	1.3	4.1	5.1	6.1	6.2	6.3							
	•	1.4	2.1	3.1	3.2	3.3	3.4	4.2	5.2	7.1	7.2	7.3	8.1			
C246	▪	1.1	1.2	1.3	1.4	3.1	3.2	3.3	3.4	4.1	4.2	5.1	5.2	6.1	6.2	6.3
	•	1.5	1.6	2.1	2.3	4.3	5.3	6.4	7.1	7.2	7.3	7.4	8.1			

C247	HSS-E PM		N	Z 4-8		$\lambda 30^\circ$ $\gamma 12^\circ$	DIN 1835B		k10		DIN 844K
C246	HSS-E PM		N	Z 4-6		$\lambda 30^\circ$ $\gamma 12^\circ$	DIN 1835B	TIPN	k10		DIN 844K

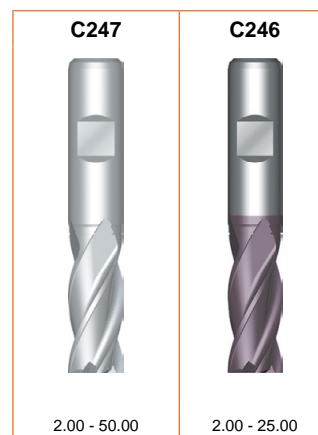
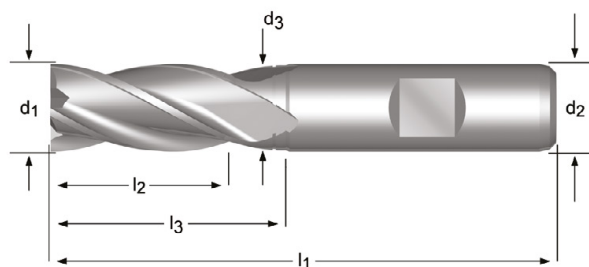

d_1 Ø Inch	d_1 Ø mm	d_2 Ø _{h6} mm	l_2 mm	l_1 mm	z	l_3 mm	d_3 Ø mm	C247	C246
	2.00	6	7	51	4	-	-	C2472.0	C2462.0
	2.50	6	8	52	4	-	-	C2472.5	
1/8	3.00	6	8	52	4	-	-	C2473.0	C2463.0
	3.18	6	10	54	4	-	-	C2471/8 ¹⁾	
	3.50	6	10	54	4	-	-	C2473.5	
	4.00	6	11	55	4	-	-	C2474.0	C2464.0
	4.50	6	11	55	4	-	-	C2474.5	
3/16	4.76	6	13	57	4	-	-	C2473/16 ¹⁾	
	5.00	6	13	57	4	-	-	C2475.0	C2465.0
	5.50	6	13	57	4	-	-	C2475.5	
1/4	6.00	6	13	57	4	-	-	C2476.0	C2466.0
	6.35	10	16	66	4	-	-	C2471/4 ¹⁾	
	6.50	10	16	66	4	-	-	C2476.5	
	7.00	10	16	66	4	-	-	C2477.0	C2467.0
5/16	7.50	10	16	66	4	-	-	C2477.5	
	7.94	10	19	69	4	-	-	C2475/16 ¹⁾	
	8.00	10	19	69	4	-	-	C2478.0	C2468.0
	8.50	10	19	69	4	-	-	C2478.5	
	9.00	10	19	69	4	-	-	C2479.0	
3/8	9.50	10	19	69	4	-	-	C2479.5	
	9.52	10	22	72	4	31.5	9.5	C2473/8 ¹⁾	
	10.00	10	22	72	4	31.5	9.5	C24710.0	C24610.0
	11.00	12	22	79	4	-	-	C24711.0	C24611.0
	12.00	12	26	83	4	37.5	11.5	C24712.0	C24612.0
1/2	12.70	12	26	83	4	37.5	11.5	C2471/2 ¹⁾	
	13.00	12	26	83	4	37.5	11.5	C24713.0	C24613.0
	14.00	12	26	83	4	37.5	11.5	C24714.0	C24614.0
9/16	14.29	12	26	83	4	37.5	11.5	C2479/16 ¹⁾	
	15.00	12	26	83	4	37.5	11.5	C24715.0	C24615.0
5/8	15.88	16	32	92	4	43.5	15.5	C2475/8 ¹⁾	

¹⁾ tolerance průměru + .0025" / -.0005" / допуск на диаметр +0.0025 дюйма / -0.0005 дюйма / Tolerancja średnicy +.0025 cala / -.0005 cala / tolerancia priemeru + .0025" / -.0005"

d ₁ Ø Inch	d ₁ Ø mm	d ₂ Øh ₆ mm	l ₂ mm	l ₁ mm	z	l ₃ mm	d ₃ Ø mm	C247	C246
	16.00	16	32	92	4	43.5	15.5	C24716.0	C24616.0
	17.00	16	32	92	4	43.5	15.5	C24717.0	
	18.00	16	32	92	4	43.5	15.5	C24718.0	C24618.0
	19.00	16	32	92	4	43.5	15.5	C24719.0	
3/4	19.05	20	38	104	4	53.5	18.5	C2473/4 ¹⁾	
	20.00	20	38	104	4	53.5	19.5	C24720.0	C24620.0
	21.00	20	38	104	4	53.5	19.5	C24721.0	
	22.00	20	38	104	5	53.5	19.5	C24722.0	C24622.0
7/8	22.22	20	38	104	5	53.5	19.5	C2477/8 ¹⁾	
	23.00	20	38	104	5	53.5	19.5	C24723.0	
	24.00	25	45	121	5	64.5	23.5	C24724.0	
	25.00	25	45	121	5	64.5	24.5	C24725.0	C24625.0
1"	25.40	25	45	121	5	64.5	24.5	C2471 ¹⁾	
	26.00	25	45	121	6	64.5	24.5	C24726.0	
	28.00	25	45	121	6	64.5	24.5	C24728.0	
	30.00	25	45	121	6	64.5	24.5	C24730.0	
	32.00	32	53	133	6	72.5	31.5	C24732.0	
	36.00	32	53	133	6	72.5	31.5	C24736.0 ²⁾³⁾	
	40.00	40	63	155	6	84.5	39.0	C24740.0 ²⁾³⁾	
	50.00	50	75	177	8	96.5	48.0	C24750.0 ²⁾³⁾	

¹⁾ tolerance průměru + .0025" / -.0005" / допуск на диаметр +0.0025 дюйма / -0.0005 дюйма / Tolerancja średnicy +.0025 cala / -.0005 cala / tolerancia priemeru + .0025" / -.0005"

²⁾ Bez středícího břítu / Без перекрытия центра / Bez ostrza centralnego / Bez strediaceho břítu

³⁾ Pouze HSCo. / Заказ только в исполнении из быстрорежущей стали / Dostępne tylko jako HSCo / Iba HSS-Co

C273 • Stopkové frézy
• Концевые фрезы

C295 • Frezy walcowo-czołowe
• Stopkové frézy

C273	▪	1.1	1.2	1.3	4.1	5.1	6.1	6.2	6.3									
	•	1.4	2.1	3.1	3.2	3.3	3.4	4.2	5.2	7.1	7.2	7.3	8.1					
C295	▪	1.1	1.2	1.3	1.4	3.1	3.2	3.3	3.4	4.1	4.2	5.1	5.2	6.1	6.2	6.3		
	•	1.5	1.6	2.1	2.3	4.3	5.3	6.4	7.1	7.2	7.3	7.4	8.1					

C273	HSS-E PM		N	Z 4-6		λ 30° γ 12°	DIN 1835B		k10		DIN 844L
C295	HSS-E PM		N	Z 4-6		λ 30° γ 12°	DIN 1835B	TICN	k10		DIN 844L

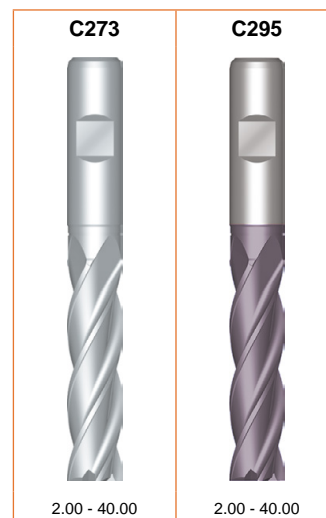
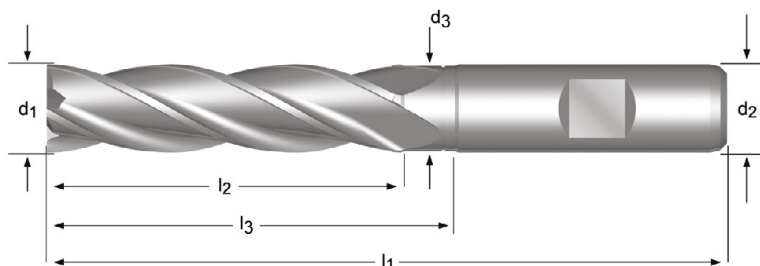

d_1 Ø Inch	d_1 Ø mm	d_2 Ø _{h6} mm	l_2 mm	l_1 mm	z	l_3 mm	d_3 Ø mm	C273	C295
1/8	2.00	6	10	54	4	-	-	C2732.0	C2952.0
	2.50	6	12	56	4	-	-	C2732.5	
	3.00	6	12	56	4	-	-	C2733.0	C2953.0
	3.18	6	15	59	4	-	-	C2731/8 ¹⁾	
	3.50	6	15	59	4	-	-	C2733.5	
3/16	4.00	6	19	63	4	-	-	C2734.0	C2954.0
	4.50	6	19	63	4	-	-	C2734.5	
	4.76	6	24	68	4	-	-	C2733/16 ¹⁾	
	5.00	6	24	68	4	-	-	C2735.0	C2955.0
	5.50	6	24	68	4	-	-	C2735.5	
1/4	6.00	6	24	68	4	-	-	C2736.0	C2956.0
	6.35	10	30	80	4	-	-	C2731/4 ¹⁾	
	7.00	10	30	80	4	-	-	C2737.0	C2957.0
	8.00	10	38	88	4	-	-	C2738.0	C2958.0
	9.00	10	38	88	4	-	-	C2739.0	C2959.0
3/8	9.52	10	45	95	4	54.5	9.5	C2733/8 ¹⁾	
	10.00	10	45	95	4	54.5	9.5	C27310.0	C29510.0
	11.00	12	45	102	4	-	-	C27311.0	C29511.0
	12.00	12	53	110	4	64.5	11.5	C27312.0	C29512.0
	12.70	12	53	110	4	64.5	11.5	C2731/2 ¹⁾	
1/2	13.00	12	53	110	4	64.5	11.5	C27313.0	
	14.00	12	53	110	4	64.5	11.5	C27314.0	
	15.00	12	53	110	4	64.5	11.5	C27315.0	C29515.0
	15.88	16	63	123	4	74.5	15.5	C2735/8 ¹⁾	
	16.00	16	63	123	4	74.5	15.5	C27316.0	C29516.0
	18.00	16	63	123	4	74.5	15.5	C27318.0	C29518.0

¹⁾ tolerance průměru + .0025" / -.0005" / допуск на диаметр +0.0025 дюйма / -0.0005 дюйма / Tolerancja średnicy +.0025 cala / -.0005 cala / tolerancja priemeru + .0025" / -.0005"

d_1 Ø Inch	d_1 Ø mm	d_2 Ø h_6 mm	l_2 mm	l_1 mm	z	l_3 mm	d_3 Ø mm	C273	C295
3/4	19.05	20	75	141	4	90.5	18.5	C2733/4 ¹⁾	
	20.00	20	75	141	4	90.5	19.5	C27320.0	C29520.0
	22.00	20	75	141	5	90.5	19.5	C27322.0	
	25.00	25	90	166	5	109.5	24.5	C27325.0	C29525.0
1"	25.40	25	90	166	5	109.5	24.5	C2731 ¹⁾	
	28.00	25	90	166	6	109.5	24.5	C27328.0	
	30.00	25	90	166	6	109.5	24.5	C27330.0	C29530.0
	32.00	32	106	186	6	125.5	31.5	C27332.0	C29532.0
	40.00	40	125	217	6	146.5	39.0	C27340.0 ²⁾³⁾	C29540.0

¹⁾ tolerance průměru + .0025" / -.0005" / допуск на диаметр +0.0025 дюйма / -0.0005 дюйма / Tolerancja średnicy +.0025 cala / -.0005 cala / tolerancia priemeru + .0025" / -.0005"

²⁾ Pouze HSCo. / Заказ только в исполнении из быстрорежущей стали / Dostępne tylko jako HSCo / Iba HSS-Co

³⁾ Bez středícího břítu / Без перекрытия центра / Bez ostrza centralnego / Bez strediaceho břitú

C333

- Stopkové frézy
- Концевые фрезы
- Frezy walcowo-czołowe
- Stopkové frézy

C333 ■ 6.1 6.2 6.3 7.1 7.2 7.3 8.1 8.2

C333 HSS-E PM W Z 3 λ 40° γ 25° DIN 1835B k10 DIN 844L

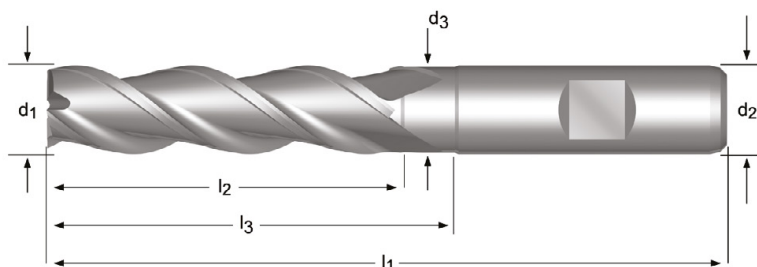

C333



10.00 - 30.00

d_1 \emptyset mm	d_2 $\emptyset h_6$ mm	l_2 mm	l_1 mm	z	l_3 mm	d_3 \emptyset mm	C333
10.00	10	45	95	3	54.5	9.5	C33310.0
12.00	12	53	110	3	64.5	11.5	C33312.0
14.00	12	53	110	3	64.5	11.5	C33314.0
16.00	16	63	123	3	74.5	15.5	C33316.0
18.00	16	63	123	3	74.5	15.5	C33318.0
20.00	20	75	141	3	90.5	19.5	C33320.0
25.00	25	90	166	3	109.5	24.5	C33325.0
30.00	25	90	166	3	109.5	24.5	C33330.0

C922

- Hrubovací frézy
- Черновые концевые фрезы
- Frezy walcowo-czołowe do obróbki zgrubnej
- Hrubovacie frézy

C922	▪	1.4	1.5	1.6	2.1	2.2	2.3	3.1	3.2	3.3	3.4	4.2	4.3	5.2	5.3	6.2	7.4
	•	1.3	4.1	5.1	6.4												

C922

HSS-E
PM

HRA

Z
3-4

λ 35°
 γ 12°

DIN
1835B

Alcrona

k12

DIN
844K

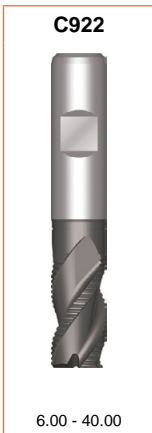
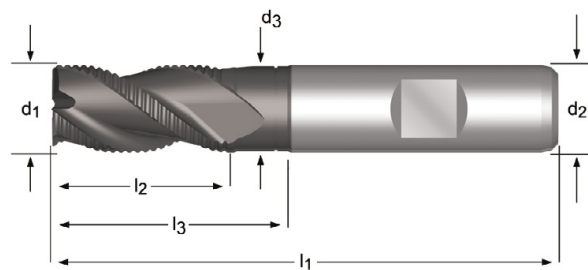

d_1 Ø mm	d_2 Ø _{h8} mm	l_2 mm	l_1 mm	z	l_3 mm	d_3 Ø mm	C922
6.00	6	13	57	3	-	-	C9226.0
7.00	10	16	66	3	-	-	C9227.0
8.00	10	19	69	3	-	-	C9228.0
9.00	10	19	69	3	-	-	C9229.0
10.00	10	22	72	3	31.5	9.5	C92210.0
11.00	12	22	79	3	-	-	C92211.0
12.00	12	26	83	3	37.5	11.5	C92212.0
13.00	12	26	83	3	37.5	11.5	C92213.0
14.00	12	26	83	3	37.5	11.5	C92214.0
15.00	12	26	83	3	37.5	11.5	C92215.0
16.00	16	32	92	3	43.5	15.5	C92216.0
18.00	16	32	92	3	43.5	15.5	C92218.0
20.00	20	38	104	3	53.5	19.5	C92220.0
22.00	20	38	104	3	53.5	19.5	C92222.0
24.00	25	45	121	4	64.5	23.5	C92224.0
25.00	25	45	121	4	64.5	24.5	C92225.0
28.00	25	45	121	4	64.5	24.5	C92228.0
32.00	32	53	133	4	72.5	31.5	C92232.0

- C428**
- Hrubovací frézy
 - Черновые концевые фрезы
 - Frezy walcowo-czołowe do obróbki zgrubnej
 - Hrubovacie frézy

C428	▪	1.4	1.5	1.6	2.1	2.2	2.3	3.1	3.2	3.3	3.4	4.2	4.3	5.2	5.3	6.2	7.4
	•	1.3	4.1	5.1	6.4												

C428

HSS-E
PM



HRA

Z
4-6



λ 35°
 γ 12°

DIN
1835B

Alcrona

k12



DIN
844K

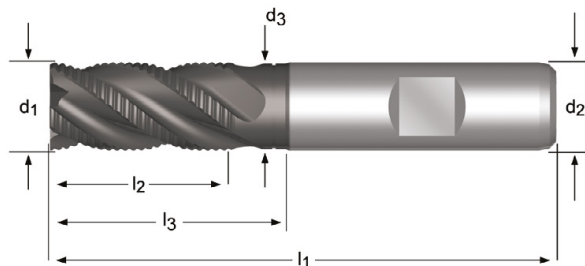

C428



6.00 - 40.00

d_1 Ø mm	d_2 Ø _{h6} mm	l_2 mm	l_1 mm	z	l_3 mm	d_3 Ø mm	C428
6.00	6	13	57	4	-	-	C4286.0
7.00	10	16	66	4	-	-	C4287.0
8.00	10	19	69	4	-	-	C4288.0
9.00	10	19	69	4	-	-	C4289.0
10.00	10	22	72	4	31.5	9.5	C42810.0
11.00	12	22	79	4	-	-	C42811.0
12.00	12	26	83	4	37.5	11.5	C42812.0
13.00	12	26	83	4	37.5	11.5	C42813.0
14.00	12	26	83	4	37.5	11.5	C42814.0
15.00	12	26	83	4	37.5	11.5	C42815.0
16.00	16	32	92	4	43.5	15.5	C42816.0
18.00	16	32	92	4	43.5	15.5	C42818.0
20.00	20	38	104	4	53.5	19.5	C42820.0
22.00	20	38	104	4	53.5	19.5	C42822.0
25.00	25	45	121	6	64.5	24.5	C42825.0
28.00	25	45	121	6	64.5	24.5	C42828.0
30.00	25	45	121	6	64.5	24.5	C42830.0
32.00	32	53	133	6	72.5	31.5	C42832.0
36.00	32	53	133	6	72.5	31.0	C42836.0
40.00	40	63	155	6	84.5	39.0	C42840.0

C492

- Hrubovací frézy
- Черновые концевые фрезы
- Frezy walcowo-czołowe do obróbki zgrubnej
- Hrubovacie frézy

C492 ■ 1.3 1.4 1.5 1.6 2.1 2.2 2.3 3.1 3.2 3.3 3.4 4.2 4.3 5.2 5.3 6.2 7.4
 • 4.1 5.1 6.4



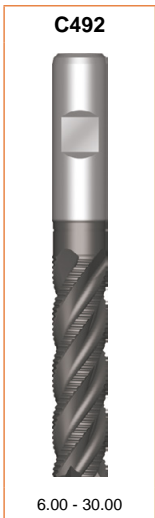
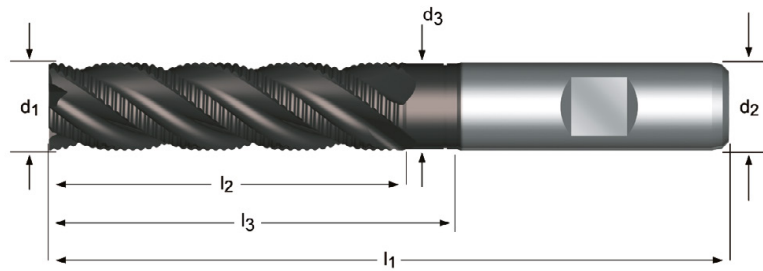





C492 HSS-E PM HRA Z 3-6 λ 35° γ 12° DIN 1835B Alcrona k12 DIN 844L



d_1 Ø mm	d_2 Ø _{h6} mm	l_2 mm	l_1 mm	z	l_3 mm	d_3 Ø mm	C492
6.00	6	24	68	3	-	-	C4926.0
8.00	10	38	88	3	-	-	C4928.0
10.00	10	45	95	4	54.5	9.5	C49210.0
12.00	12	53	110	4	64.5	11.5	C49212.0
14.00	12	53	110	4	64.5	11.5	C49214.0
16.00	16	63	123	4	74.5	15.5	C49216.0
18.00	16	63	123	4	74.5	15.5	C49218.0
20.00	20	75	141	4	90.5	19.5	C49220.0
22.00	20	75	141	4	90.5	19.5	C49222.0
25.00	25	90	166	6	109.5	24.5	C49225.0
30.00	25	90	166	6	109.5	24.5	C49230.0

- C407** • Hrubovací frézy
• Черновые концевые фрезы
- C908** • Frezy walcowo-czołowe do obróbki zgrubnej
• Hrubovacie frézy

C407	▪	1.2	1.3	1.4	1.5	2.1	2.3	3.1	3.2	3.3	3.4	4.2	4.3	5.2	5.3	6.2	
	•	1.1	1.6	2.2	4.1	5.1	6.4	7.4									
C908	▪	1.3	1.4	1.5	2.1	2.2	2.3	3.1	3.2	3.3	3.4	4.2	4.3	5.2	5.3	6.2	
	•	1.6	4.1	5.1	6.4	7.4											

C407	HSS-E PM		NRA	Z 4-6		λ 35° γ 12°	DIN 1835B		Alcrona	k12		DIN 844K
C908	HSS-E PM		NRA	Z 4-6		λ 35° γ 12°	DIN 1835B		Alcrona	k12		DIN 844K

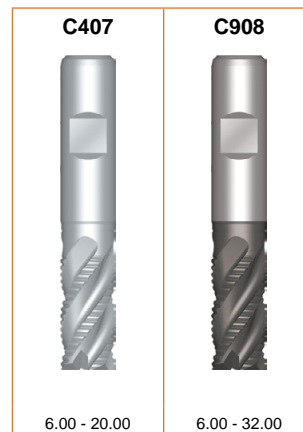
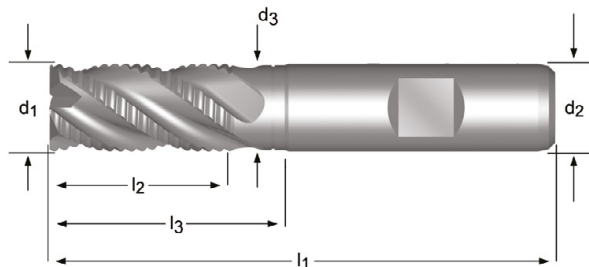

d_1 Ø mm	d_2 Ø _{h₅} mm	l_2 mm	l_1 mm	z	l_3 mm	d_3 Ø mm	C407	C908
6.00	6	13	57	4	-	-	C4076.0	C9086.0
7.00	10	16	66	4	-	-	C4077.0	C9087.0
8.00	10	19	69	4	-	-	C4078.0	C9088.0
9.00	10	19	69	4	-	-	C4079.0	C9089.0
10.00	10	22	72	4	31.5	9.5	C40710.0	C90810.0
11.00	12	22	79	4	-	-	C40711.0	C90811.0
12.00	12	26	83	4	37.5	11.5	C40712.0	C90812.0
13.00	12	26	83	4	37.5	11.5	C40713.0	C90813.0
14.00	12	26	83	4	37.5	11.5	C40714.0	C90814.0
15.00	12	26	83	4	37.5	11.5	C40715.0	C90815.0
16.00	16	32	92	4	43.5	15.5	C40716.0	C90816.0
18.00	16	32	92	4	43.5	15.5	C40718.0	C90818.0
20.00	20	38	104	4	53.5	19.5	C40720.0	C90820.0
22.00	20	38	104	4	53.5	19.5		C90822.0
25.00	25	45	121	6	64.5	24.5		C90825.0
30.00	25	45	121	6	64.5	24.5		C90830.0
32.00	32	53	133	6	72.5	31.5		C90832.0

C948

- Hrubovací frézy
- Черновые концевые фрезы
- Frezy walcowo-czołowe do obróbki zgrubnej
- Hrubovacie frézy

C948 ■ 1.3 1.4 1.5 1.6 2.1 2.2 2.3 3.1 3.2 3.3 3.4 4.2 4.3 5.2 5.3 6.2 7.4
 • 4.1 5.1 6.4

C948 HSS-E PM

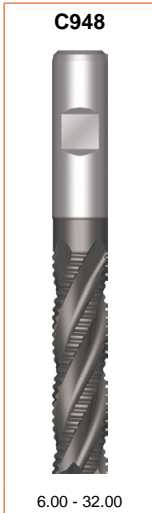
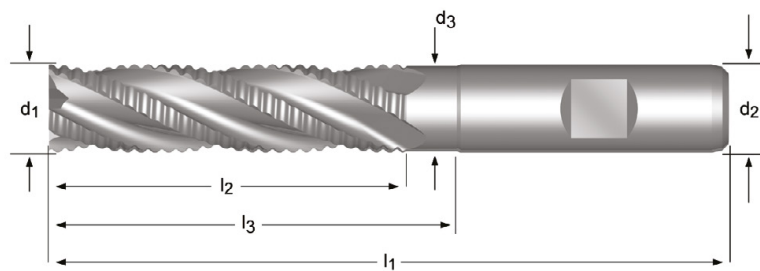

d_1 Ø mm	d_2 Ø _{h6} mm	l_2 mm	l_1 mm	z	l_3 mm	d_3 Ø mm	C948
6.00	6	24	68	4	-	-	C9486.0
8.00	10	38	88	4	-	-	C9488.0
10.00	10	45	95	4	54.5	9.5	C94810.0
12.00	12	53	110	4	64.5	11.5	C94812.0
14.00	12	53	110	4	64.5	11.5	C94814.0
16.00	16	63	123	4	74.5	15.5	C94816.0
18.00	16	63	123	4	74.5	15.5	C94818.0
20.00	20	75	141	4	90.5	19.5	C94820.0
25.00	25	90	166	6	109.5	24.5	C94825.0
30.00	25	90	166	6	109.5	24.5	C94830.0
32.00	32	106	186	6	125.5	31.5	C94832.0

- C400** • Hrubovací frézy
• Черновые концевые фрезы
- C413** • Frezy walcowo-czołowe do obróbki zgrubnej
• Hrubovacie frézy

C400	▪	1.2	1.3	6.2	6.3											
	•	1.1	1.4	2.1	3.1	3.2	3.3	3.4	4.1	4.2	5.1	5.2	6.1	7.2	7.3	8.1
C413	▪	1.2	1.3	1.4	3.1	3.2	3.3	3.4	4.2	5.2	6.2	6.3				
	•	1.1	1.5	1.6	2.1	2.3	4.1	4.3	5.1	5.3	6.1	6.4	7.2	7.3	7.4	8.1

C400	HSS-E		NF	Z 4-6		λ 30° γ 12°	DIN 1835B		k12		DIN 844K
C413	HSS-E		NF	Z 4-6		λ 30° γ 12°	DIN 1835B	TiCN	k12		DIN 844K

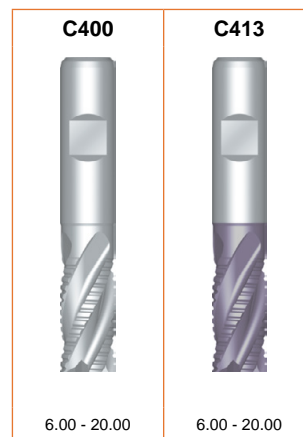
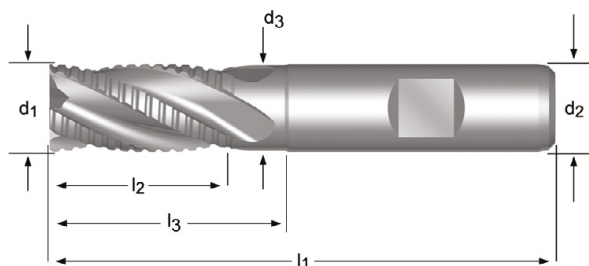

d_1 Ø mm	d_2 Ø _{h6} mm	l_2 mm	l_1 mm	z	l_3 mm	d_3 Ø mm	C400	C413
6.00	6	13	57	4	-	-	C4006.0	C4136.0
8.00	10	19	69	4	-	-	C4008.0	C4138.0
10.00	10	22	72	4	-	-	C40010.0	C41310.0
12.00	12	26	83	4	-	-	C40012.0	C41312.0
14.00	12	26	83	4	37.5	11.5	C40014.0	C41314.0
16.00	16	32	92	4	43.5	15.5	C40016.0	C41316.0
18.00	16	32	92	4	43.5	15.5	C40018.0	C41318.0
20.00	20	38	104	4	53.5	19.5	C40020.0	C41320.0

C403

- Hrubovací frézy
- Черновые концевые фрезы
- Frezy walcowo-czołowe do obróbki zgrubnej
- Hrubovacie frézy

C403 ■ 1.2 1.3 6.2 6.3
 • 1.1 1.4 2.1 3.1 3.2 3.3 3.4 4.1 4.2 5.1 5.2 6.1 7.2 7.3 8.1

C403 HSS-E NF Z 4-6 $\lambda 30^\circ$ $\gamma 12^\circ$ DIN 1835B k12 DIN 844L

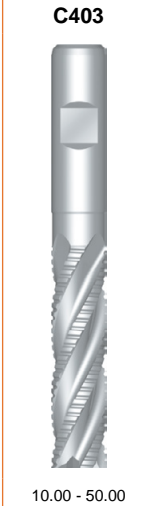
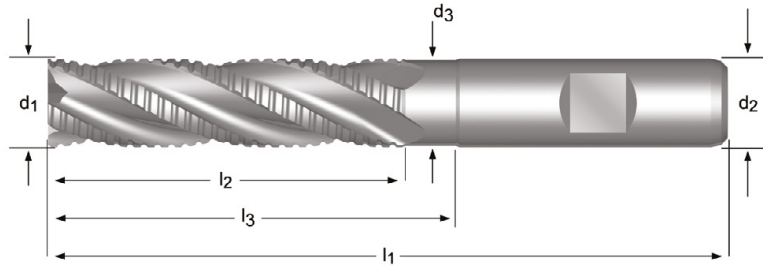

d_1 Ø mm	d_2 Ø _{h6} mm	l_2 mm	l_1 mm	z	l_3 mm	d_3 Ø mm	C403
10.00	10	45	95	4	-	-	C40310.0
12.00	12	53	110	4	-	-	C40312.0
14.00	12	53	110	4	64.5	11.5	C40314.0
16.00	16	63	123	4	74.5	15.5	C40316.0
18.00	16	63	123	4	74.5	15.5	C40318.0
20.00	20	75	141	4	90.5	19.5	C40320.0
30.00	25	90	166	5	109.5	24.5	C40330.0
32.00	32	106	186	6	125.5	31.0	C40332.0
36.00	32	106	186	6	125.5	31.5	C40336.0
40.00	40	125	217	6	146.5	39.0	C40340.0
45.00	40	125	217	6	146.5	39.5	C40345.0
50.00	50	150	252	6	171.5	48.0	C40350.0

C500

- Kopírovací frézy
- Сферические концевые фрезы
- Frezy kuliste
- Kopirovacie frézy

C500	▪	1.1	1.2	4.1	5.1	6.1	6.2	6.3							
	•	1.3	1.4	2.1	3.1	3.2	3.3	3.4	4.2	5.2	7.1	7.2	7.3	8.1	

C500 HSS-E  N  Z 2   $\lambda 30^\circ$ $\gamma 12^\circ$   e8  DIN 327D

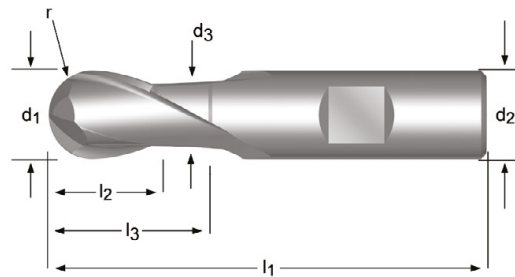

C500



2.00 - 25.00

d_1 Ø mm	r ±0.05 mm	d_2 Ø _{h6} mm	l_2 mm	l_1 mm	z	l_3 mm	d_3 Ø mm	C500
2.00	1.00	6	4	48	2	-	-	C5002.0
3.00	1.50	6	5	49	2	-	-	C5003.0
4.00	2.00	6	7	51	2	-	-	C5004.0
5.00	2.50	6	8	52	2	-	-	C5005.0
6.00	3.00	6	8	52	2	-	-	C5006.0
7.00	3.50	10	10	60	2	-	-	C5007.0
8.00	4.00	10	11	61	2	-	-	C5008.0
9.00	4.50	10	11	61	2	-	-	C5009.0
10.00	5.00	10	13	63	2	-	-	C50010.0
12.00	6.00	12	16	73	2	-	-	C50012.0
14.00	7.00	12	16	73	2	27.5	11.5	C50014.0
15.00	7.50	12	16	73	2	27.5	11.5	C50015.0
16.00	8.00	16	19	79	2	30.5	15.5	C50016.0
18.00	9.00	16	19	79	2	30.5	15.5	C50018.0
20.00	10.00	20	22	88	2	37.5	19.5	C50020.0
25.00	12.50	25	26	102	2	45.5	24.5	C50025.0

C505

- Kopřovací frézy
- Сферические концевые фрезы
- Frezy kuliste
- Kopřovacie frézy

C505	▪	1.1	1.2	4.1	5.1	6.1	6.2	6.3						
	•	1.3	1.4	2.1	3.1	3.2	3.3	3.4	4.2	5.2	7.1	7.2	7.3	8.1

C505	HSS-E		N	Z 2		$\lambda 30^\circ$ $\gamma 12^\circ$	DIN 1835B		e8		DIN 844K
------	-------	--	---	--------	--	---	--------------	--	----	--	-------------

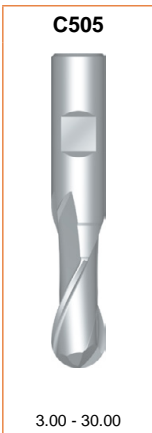
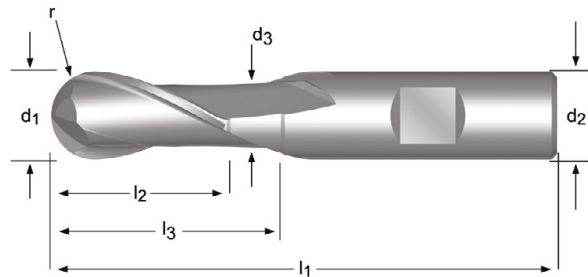

d_1 \varnothing mm	r ± 0.05 mm	d_2 $\varnothing h_6$ mm	l_2 mm	l_1 mm	z	l_3 mm	d_3 \varnothing mm	C505
3.00	1.50	6	8	52	2	-	-	C5053.0
4.00	2.00	6	11	55	2	-	-	C5054.0
5.00	2.50	6	13	57	2	-	-	C5055.0
6.00	3.00	6	13	57	2	-	-	C5056.0
8.00	4.00	10	19	69	2	-	-	C5058.0
10.00	5.00	10	22	72	2	-	-	C50510.0
12.00	6.00	12	26	83	2	-	-	C50512.0
14.00	7.00	12	26	83	2	37.5	11.5	C50514.0
16.00	8.00	16	32	92	2	43.5	15.5	C50516.0
20.00	10.00	20	38	104	2	53.5	19.5	C50520.0
22.00	11.00	20	38	104	2	53.5	19.5	C50522.0
25.00	12.50	25	45	121	2	64.5	24.5	C50525.0
28.00	14.00	25	45	121	2	64.5	24.5	C50528.0
30.00	15.00	25	45	121	2	64.5	24.5	C50530.0

C800

- Frézy T-drážky
- Фрезы для обработки T-образных пазов
- Frezy do rowków teowych
- Frézy T-drážky

C800	1.1	1.2	1.3	1.4	1.5	1.6	2.1	2.2	2.3	3.1	3.2	3.3	3.4	4.1	4.2	4.3	5.1	5.2	5.3	6.1
	6.2	6.3	6.4	7.1	7.2	7.3	7.4	8.1	10.1											

C800 HSS-E  N  Z 6-8  $\lambda 15^\circ$ $\gamma 10^\circ$  DIN 1835  d11   DIN 851

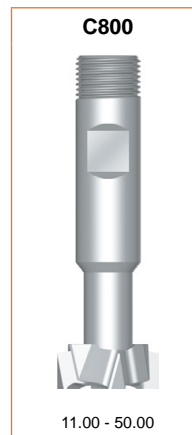
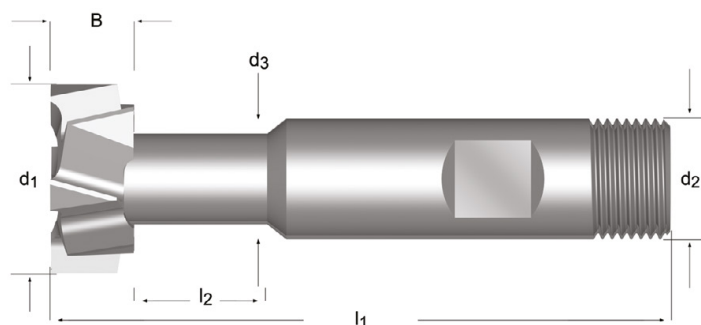

B	d ₁ ∅ mm	T DIN650	d ₃ ∅ mm	l ₂ mm	l ₁ mm	d ₂ ∅h ₆ mm	z	C800
4.0	11.00	5	4	6.5	53.5	10	6	C80011.0X5.0
6.0	12.50	6	5	9	57.0	10	6	C80012.5X6.0
8.0	16.00	8	7	12	62.0	10	6	C80016.0X8.0
8.0	18.00	10	8	15	70.0	12	6	C80018.0X10.0
9.0	21.00	12	10	18	74.0	12	8	C80021.0X12.0
11.0	25.00	14	12	20	82.0	16	8	C80025.0X14.0
14.0	32.00	18	15	26	90.0	16	8	C80032.0X18.0
18.0	40.00	22	19	27	108.0	25	8	C80040.0X22.0
22.0	50.00	28	25	34	124.0	32	8	C80050.0X28.0

C810

- Frézy T-drážky
- Фрезы для обработки T-образных пазов
- Frezy do rowków teowych
- Frézy T-drážky

C810	▪	1.1	1.2	1.3	1.4	2.1	3.1	3.2	3.3	3.4	4.1	5.1	6.1	6.2	6.3	6.4	7.1	7.2	7.3	
	•	1.5	1.6	2.2	2.3	4.2	4.3	5.2	5.3	7.4	8.1	10.1								

C810 HSS N Z 6-8 $\lambda 12^\circ$ $\gamma 10^\circ$

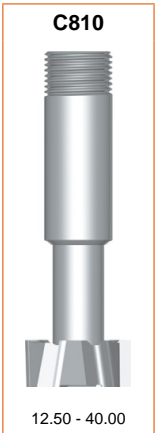
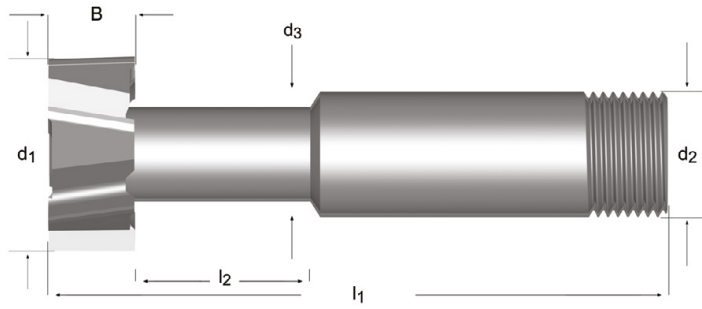

B	d ₁ Ø	T DIN650	d ₃ Ø	l ₂	l ₁	d ₂ Ø0,-0.025	z	C810
mm	mm		mm	mm	mm	mm		
6.00	12.50	6.0	5.00	11	57.0	10.0	6	C8106.0
8.00	16.00	8.0	7.00	13	61.0	10.0	6	C8108.0
8.00	18.00	10.0	8.00	17	65.0	12.0	6	C81010.0
9.00	21.00	12.0	10.00	20	69.0	12.0	6	C81012.0
11.00	25.00	14.0	12.00	23	79.0	16.0	6	C81014.0
12.00	28.00	16.0	13.00	23	76.0	16.0	6	C81016.0
14.00	32.00	18.0	15.00	27	98.0	25.0	8	C81018.0
16.00	36.00	20.0	17.00	30	100.0	25.0	8	C81020.0
18.00	40.00	22.0	19.00	33	108.0	25.0	8	C81022.0

⁹⁾ Standard - BS 122/4 / Стандарт - BS 122/4 / Standard - BS 122/4 / Štandard - BS 122/4

C825

- Frézy T-drażky
- Фрезы для обработки T-образных пазов
- Frezy do rowków teowych
- Frézy T-drażky

C825	1.1	1.2	1.3	1.4	1.5	1.6	2.1	2.2	2.3	3.1	3.2	3.3	3.4	4.1	4.2	4.3	5.1	5.2	5.3	6.1	
	6.2	6.3	6.4	7.1	7.2	7.3	7.4	8.1	10.1												

C825 HSS-E  N  Z 8-12  $\lambda 15^\circ$ $\gamma 15^\circ$  js16  

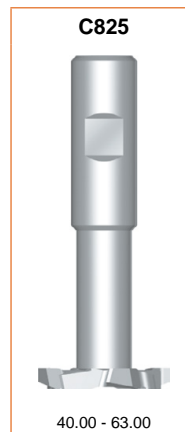
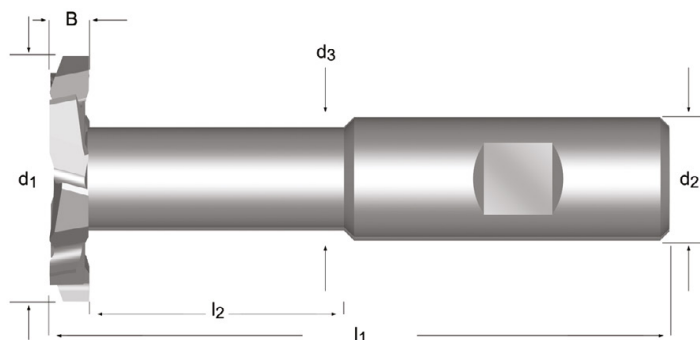

B	d ₁	Ch	d ₃	l ₂	l ₁	d ₂	z	C825
mm	∅ mm	mm	∅ mm	mm	mm	∅ h ₆ mm		
3	40	0.15	19.2	46	100	20	8	C8253.0X40.0
4	40	0.15	19.2	45	100	20	8	C8254.0X40.0
5	40	0.15	19.2	44	100	20	8	C8255.0X40.0
6	40	0.15	19.2	43	100	20	8	C8256.0X40.0
8	40	0.15	19.2	41	100	20	8	C8258.0X40.0
10	40	0.15	19.2	39	100	20	8	C82510.0X40.0
6	63	0.15	24.2	67	130	25	12	C8256.0X63.0
8	63	0.15	24.2	65	130	25	12	C8258.0X63.0
10	63	0.15	24.2	63	130	25	12	C82510.0X63.0
12	63	0.15	24.2	61	130	25	12	C82512.0X63.0
14	63	0.15	24.2	59	130	25	12	C82514.0X63.0
16	63	0.15	24.2	57	130	25	12	C82516.0X63.0

- C801**
- Frézy T-drážky
 - Фрезы для обработки T-образных пазов
 - Frezy do rowków teowych
 - Frézy T-drážky

C801	1.1	1.2	1.3	1.4	1.5	1.6	2.1	2.2	2.3	3.1	3.2	3.3	3.4	4.1	4.2	4.3	5.1	5.2	5.3	6.1	
	6.2	6.3	6.4	7.1	7.2	7.3	7.4	8.1	10.1												

C801 HSS-E

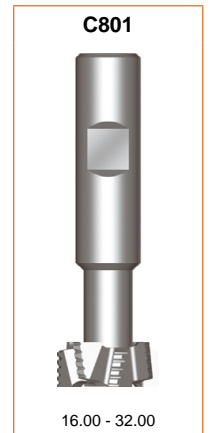
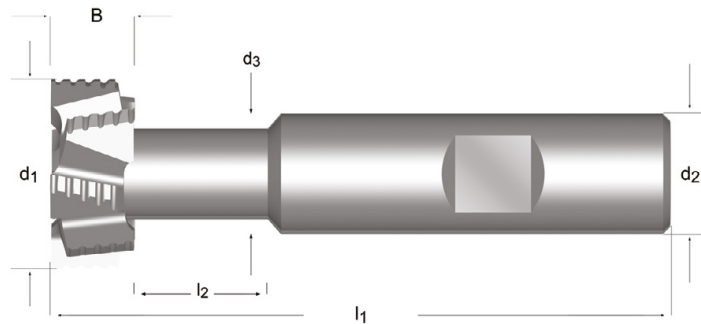

B	d ₁ ∅	T DIN650	d ₃ ∅	l ₂	l ₁	d ₂ ∅h ₆	z	C801
8.0	16.0	8	7	10	62	10	6	C80116.0X8.0
8.0	18.0	10	8	13	70	12	6	C80118.0X10.0
9.0	21.0	12	10	16	74	12	6	C80121.0X12.0
11.0	25.0	14	12	17	82	16	8	C80125.0X14.0
14.0	32.0	18	15	22	90	16	8	C80132.0X18.0

- C822**
- Frézy pro drážky Woodruff
 - Фрезы для обработки сегментных шпоночных пазов
 - Frezy do rowków na wpusty Woodruff
 - Frézy pre drážky Woodruff

C822	1.1	1.2	1.3	1.4	1.5	1.6	2.1	2.2	2.3	3.1	3.2	3.3	3.4	4.1	4.2	4.3	5.1	5.2	5.3	6.1	
	6.2	6.3	6.4	7.1	7.2	7.3	7.4	8.1	10.1												

C822 HSS-E  N  Z 6-12  $\lambda 10^\circ$ $\gamma 10^\circ$  DIN 1835  h11   DIN 850

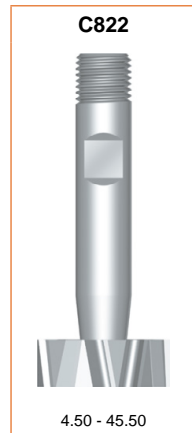
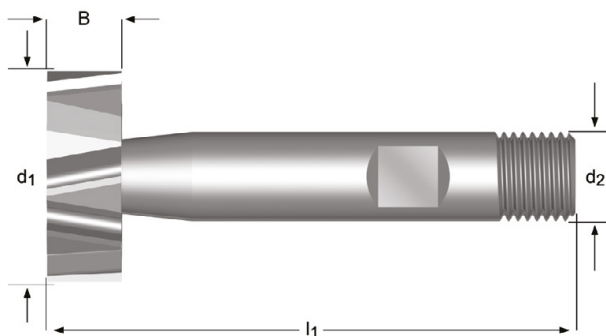

B	d ₁ Ø	l ₁	d ₂ Ø h ₆	z	C822
mm	mm	mm	mm		
1.0	4.50	50	6	6	C8224.5X1.0
1.5	7.50	50	6	6	C8227.5X1.5
2.0	7.50	50	6	6	C8227.5X2.0
2.0	10.50	50	6	8	C82210.5X2.0
2.5	10.50	50	6	8	C82210.5X2.5
3.0	10.50	50	6	8	C82210.5X3.0
3.0	13.50	56	10	8	C82213.5X3.0
4.0	13.50	56	10	8	C82213.5X4.0
3.0	16.50	56	10	8	C82216.5X3.0
4.0	16.50	56	10	8	C82216.5X4.0
5.0	16.50	56	10	8	C82216.5X5.0
3.0	19.50	63	10	10	C82219.5X3.0
4.0	19.50	63	10	10	C82219.5X4.0
5.0	19.50	63	10	10	C82219.5X5.0
5.0	22.50	63	10	10	C82222.5X5.0
6.0	22.50	63	10	10	C82222.5X6.0
8.0	22.50	63	10	10	C82222.5X8.0
6.0	25.50	63	10	12	C82225.5X6.0
6.0	28.50	63	10	12	C82228.5X6.0
8.0	28.50	63	10	12	C82228.5X8.0
10.0	28.50	71	12	12	C82228.5X10.0
8.0	32.50	71	12	12	C82232.5X8.0
10.0	32.50	71	12	12	C82232.5X10.0
10.0	45.50	71	12	12	C82245.5X10.0

- C820**
- Frézy pro drážky Woodruff
 - Фрезы для обработки сегментных шпоночных пазов
 - Frezy do rowków na wpusty Woodruff
 - Frézy pre drážky Woodruff

C820	▪	1.1	1.2	1.3	1.4	2.1	2.2	3.1	3.2	3.3	3.4	4.1	5.1	6.1	6.2	6.3	7.1	7.2	7.3
	•	1.5	1.6	2.3	4.2	4.3	5.2	5.3	6.4	7.4	8.1	10.1							

C820 HSS N Z 6-12 $\lambda 12^\circ$ $\gamma 10^\circ$

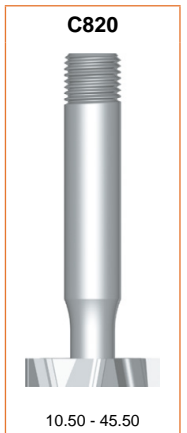
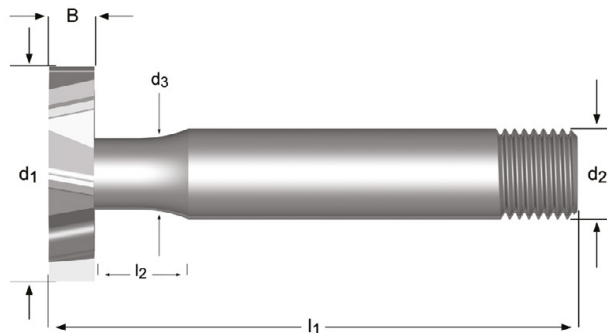

Nr.	B Inch	B mm	d ₁ Ø Inch	d ₁ Ø mm	d ₃ Ø mm	l ₂ mm	l ₁ mm	d ₂ Ø _{0,-0.025} Inch	d ₂ Ø _{0,-0.025} mm	z	C820
		2.00		10.50	3.90	10	57.0		12.0	6	C82010.5X2.0
		2.50		10.50	3.90	10	57.0		12.0	6	C82010.5X2.5
		3.00		10.50	4.20	10	57.0		12.0	6	C82010.5X3.0
204	1/16	1.59	1/2	12.70	3.30	10	57.0	1/2	12.7	6	C820204 ⁹⁾
404	1/8	3.18	1/2	12.70	4.85	10	57.0	1/2	12.7	6	C820404 ⁹⁾
		2.00		13.50	4.00	10	57.0		12.0	6	C82013.5X2.0
		2.50		13.50	4.00	10	57.0		12.0	6	C82013.5X2.5
		3.00		13.50	5.00	10	57.0		12.0	6	C82013.5X3.0
		4.00		13.50	5.00	10	57.0		12.0	6	C82013.5X4.0
405	1/8	3.18	5/8	15.88	5.65	10	57.0	1/2	12.7	6	C820405 ⁹⁾
505	5/32	3.97	5/8	15.88	6.35	10	57.0	1/2	12.7	6	C820505 ⁹⁾
		2.50		16.50	4.00	10	57.0		12.0	6	C82016.5X2.5
		3.00		16.50	5.00	10	57.0		12.0	6	C82016.5X3.0
		4.00		16.50	5.00	10	57.0		12.0	6	C82016.5X4.0
		5.00		16.50	5.60	10	57.0		12.0	6	C82016.5X5.0
406	1/8	3.18	3/4	19.05	5.50	10	57.0	1/2	12.7	6	C820406 ⁹⁾
506	5/32	3.97	3/4	19.05	6.35	10	57.0	1/2	12.7	6	C820506 ⁹⁾
606	3/16	4.76	3/4	19.05	7.15	10	57.0	1/2	12.7	6	C820606 ⁹⁾
		3.00		19.50	5.60	10	57.0		12.0	6	C82019.5X3.0
		4.00		19.50	5.60	10	57.0		12.0	6	C82019.5X4.0
		5.00		19.50	6.00	10	57.0		12.0	6	C82019.5X5.0
507	5/32	3.97	7/8	22.23	6.35	10	63.5	1/2	12.7	8	C820507 ⁹⁾
607	3/16	4.76	7/8	22.23	7.15	10	63.5	1/2	12.7	8	C820607 ⁹⁾
807	1/4	6.35	7/8	22.23	8.75	10	63.5	1/2	12.0	8	C820807 ⁹⁾
		4.00		22.50	5.60	10	63.5		12.0	8	C82022.5X4.0
		5.00		22.50	6.00	10	63.5		12.0	8	C82022.5X5.0
		6.00		22.50	6.50	10	63.5		12.0	8	C82022.5X6.0
608	3/16	4.76	1"	25.40	7.15	10	70.0	1/2	12.7	8	C820608 ⁹⁾
808	1/4	6.35	1"	25.40	8.75	10	70.0	1/2	12.7	8	C820808 ⁹⁾
		5.00		25.50	7.50	10	70.0		12.0	8	C82025.5X5.0
		6.00		25.50	7.50	10	70.0		12.0	8	C82025.5X6.0
		8.00		25.50	8.00	10	70.0		12.0	8	C82025.5X8.0
		5.00		28.50	8.00	12	70.0		12.0	8	C82028.5X5.0
		6.00		28.50	8.50	12	70.0		12.0	8	C82028.5X6.0
		8.00		28.50	9.00	12	70.0		12.0	8	C82028.5X8.0
610	3/16	4.76	1.1/4	31.75	7.95	12	70.0	1/2	12.7	10	C820610 ⁹⁾
810	1/4	6.35	1.1/4	31.75	9.50	12	70.0	1/2	12.7	10	C820810 ⁹⁾

⁹⁾ Standard - BS 122/4 / Стандарт - BS 122/4 / Standard - BS 122/4 / Standard - BS 122/4

Nr.	B Inch	B mm	d ₁ Ø Inch	d ₁ Ø mm	d ₃ Ø mm	l ₂ mm	l ₁ mm	d ₂ Ø0,-0.025 Inch	d ₂ Ø0,-0.025 mm	z	C820
1210	3/8	9.53	1.1/4	31.75	11.95	12	70.0	1/2	12.7	10	C8201210 ⁹⁾
		5.00		32.50	8.00	12	70.0		12.0	10	C82032.5X5.0 ⁹⁾
		6.00		32.50	8.50	12	70.0		12.0	10	C82032.5X6.0
		8.00		32.50	9.00	12	70.0		12.0	10	C82032.5X8.0
811	1/4	6.35	1.3/8	34.93	11.10	20	76.0	1/2	12.7	10	C820811 ⁹⁾
1211	3/8	9.53	1.3/8	34.93	11.95	20	76.0	1/2	12.7	10	C8201211 ⁹⁾
		6.00		35.50	9.50	20	76.0		12.0	10	C82035.5X6.0
		8.00		35.50	11.50	20	76.0		12.0	10	C82035.5X8.0
812	1/4	6.35	1.1/2	38.10	11.10	20	76.0	1/2	12.7	10	C820812 ⁹⁾
1212	3/8	9.53	1.1/2	38.10	11.95	20	76.0	1/2	12.7	10	C8201212 ⁹⁾
		8.00		38.50	11.50	20	76.0		12.0	10	C82038.5X8.0
		10.00		38.50	11.50	20	76.0		12.0	10	C82038.5X10.0
		10.00		45.50	11.50	20	76.0		12.0	12	C82045.5X10.0

C837

- Rybinovité frézy
- Фрезы для обработки пазов типа "ласточкин хвост"
- Frezy do rowków trapezowych
- Rybinovité frézy

C837	▪	1.1	1.2	1.3	1.4	2.1	3.1	3.2	3.3	3.4	4.1	5.1	6.1	6.2	6.3	7.1	7.2	7.3	
	•	1.5	1.6	2.2	2.3	4.2	4.3	5.2	5.3	6.4	7.4	8.1							

C837 HSS N Z 6-8 $\lambda 0^\circ$ $\gamma 0^\circ$ DIN 1835D

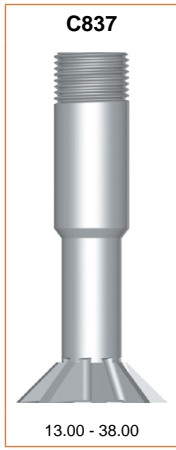
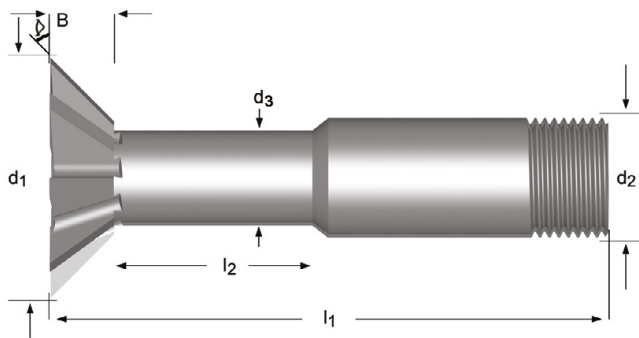

	B	d ₁	d ₁	d ₃	l ₂	l ₁	d ₂	d ₂	z	C837
	mm	Ø	Ø	Ø	mm	mm	Ø0,-0.025	Ø0,-0.025		
		Inch	mm	mm			Inch	mm		
45°	3.0		13.00	4.75	16.5	63.5		12.00	6	C83713.0
45°	4.0	5/8	15.88	6.35	17.5	66.5	1/2	12.70	6	C8375/8 ⁹⁾
45°	4.0		16.00	6.35	17.5	66.5		12.00	6	C83716.0
45°	5.5		19.00	6.35	16.0	66.5		12.00	6	C83719.0
45°	5.5	3/4	19.05	6.35	16.0	66.5	1/2	12.70	6	C8373/4 ⁹⁾
45°	6.5		22.00	7.15	16.0	68.5		12.00	6	C83722.0
45°	6.5	7/8	22.23	7.15	16.0	68.5	1/2	12.70	6	C8377/8 ⁹⁾
45°	7.5		25.00	7.95	16.5	70.0		12.00	6	C83725.0
45°	8.0	1"	25.40	7.95	16.0	70.0	1/2	12.70	6	C8371
45°	8.5		28.00	9.55	17.0	71.5		16.00	6	C83728.0
45°	10.5		38.00	12.70	16.0	78.5		25.00	8	C83738.0

⁹⁾ Standard - BS 122/4 / Стандарт - BS 122/4 / Standard - BS 122/4 / štandard - BS 122/4

C835

- Rybinovité frézy
- Фрезы для обработки пазов типа "ласточкин хвост"
- Frezy do rowków trapezowych
- Rybinovité frézy

C835	▪	1.1	1.2	1.3	1.4	2.1	3.1	3.2	3.3	3.4	4.1	5.1	6.1	6.2	6.3	7.1	7.2	7.3	
	•	1.5	1.6	2.2	2.3	4.2	4.3	5.2	5.3	6.4	7.4	8.1							

C835 HSS N Z 6-8 $\lambda 0^\circ$ $\gamma 0^\circ$ DIN 1835D

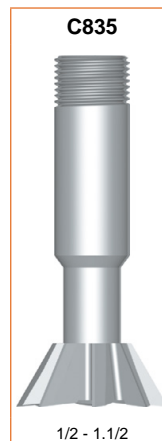
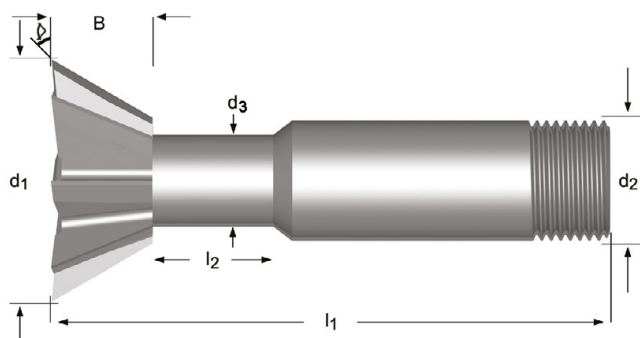

\triangle	B	d ₁	d ₁	d ₃	l ₂	l ₁	d ₂	d ₂	z	C835
	mm	Ø Inch	Ø mm	Ø mm	mm	mm	Ø0,-0.025 Inch	Ø0,-0.025 mm		
60°	4.0	1/2	12.70	7.15	16.5	63.5	1/2	12.70	6	C8351/2 ⁹⁾
60°	4.0		13.00	7.15	16.5	63.5		12.00	6	C83513.0
60°	5.5	5/8	15.88	7.55	18.0	66.5	1/2	12.70	6	C8355/8 ⁹⁾
60°	5.5		16.00	7.55	18.0	66.5		12.00	6	C83516.0
60°	7.0		19.00	8.35	17.5	67.5		12.00	6	C83519.0
60°	7.0	3/4	19.05	8.35	17.5	67.5	1/2	12.70	6	C8353/4 ⁹⁾
60°	9.5		22.00	8.75	15.0	67.5		12.00	6	C83522.0
60°	9.5	7/8	22.23	8.75	15.0	67.5	1/2	12.70	6	C8357/8 ⁹⁾
60°	12.0		25.00	8.75	15.0	70.0		12.00	6	C83525.0
60°	12.0	1"	25.40	8.75	15.0	70.0	1/2	12.70	6	C8351 ⁹⁾
60°	12.5		28.00	11.10	15.5	73.0		16.00	6	C83528.0
60°	12.5	1.1/8	28.58	11.10	15.5	73.0	5/8	15.88	6	C8351.1/8 ⁹⁾
60°	13.5		32.00	12.70	16.0	74.5		16.00	8	C83532.0
60°	13.5	1.1/4	31.75	12.70	16.0	74.5	5/8	15.88	8	C8351.1/4 ⁹⁾
60°	14.5	1.3/8	34.93	12.70	16.0	82.5	1"	25.40	8	C8351.3/8 ⁹⁾
60°	14.5		35.00	12.70	16.0	82.5		25.00	8	C83535.0
60°	16.0		38.00	17.45	16.0	84.0		25.00	8	C83538.0
60°	16.0	1.1/2	38.10	17.45	16.0	84.0	1"	25.40	8	C8351.1/2 ⁹⁾

- C830**
- Rybinovité frézy
 - Фрезы для обработки пазов типа "ласточкин хвост"
 - Frezy do rowków trapezowych
 - Rybinovité frézy

C830	1.1	1.2	1.3	1.4	1.5	1.6	2.1	2.2	2.3	3.1	3.2	3.3	3.4	4.1	4.2	4.3	5.1	5.2	5.3	6.1	
	6.2	6.3	6.4	7.1	7.2	7.3	7.4	8.1	10.1												

C830 HSS-E N Z 10-12 $\lambda 0^\circ$ $\gamma 0^\circ$

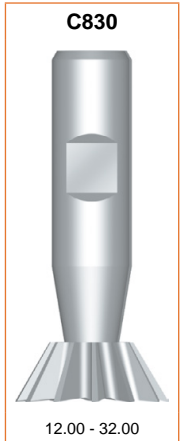
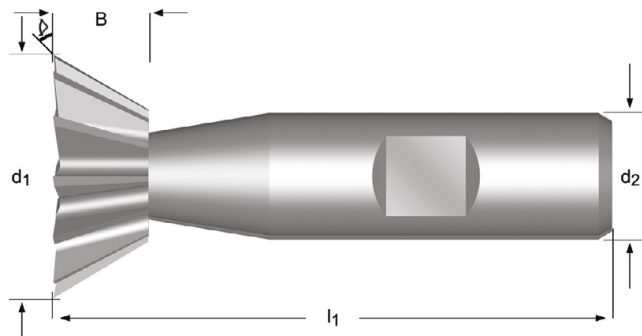



	B mm	d ₁ ∅ mm	l ₁ mm	d ₂ ∅ _{h₆} mm	z	C830
45°	3.5	12.0	54	10	10	C83012.0X45
45°	4.0	16.0	60	12	10	C83016.0X45
45°	5.0	20.0	63	12	10	C83020.0X45
45°	6.3	25.0	67	12	10	C83025.0X45
45°	8.0	32.0	71	16	12	C83032.0X45
60°	5.0	12.0	54	10	10	C83012.0X60
60°	6.3	16.0	60	12	10	C83016.0X60
60°	8.0	20.0	63	12	10	C83020.0X60
60°	10.0	25.0	67	12	10	C83025.0X60
60°	12.5	32.0	71	16	12	C83032.0X60

- C831**
- Fréza rybinovitá inverzní
 - Фрезы для обработки пазов типа "обратный ласточкин хвост"
 - Frez przeciwstawny do rowków trapezowych
 - Fréza rybinovitá inverzná

C831	1.1	1.2	1.3	1.4	1.5	1.6	2.1	2.2	2.3	3.1	3.2	3.3	3.4	4.1	4.2	4.3	5.1	5.2	5.3	6.1
	6.2	6.3	6.4	7.1	7.2	7.3	7.4	8.1	10.1											

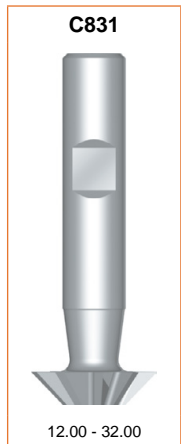
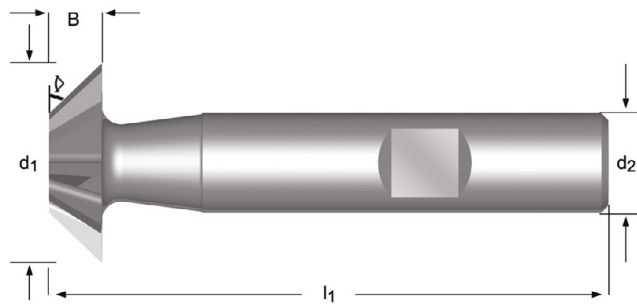
C831 HSS-E  N  Z 10-12  $\lambda 0^\circ$ $\gamma 0^\circ$  DIN 1835B  js16  DIN 1833D



	B mm	d_1 Ø mm	l_1 mm	d_2 Ø _{h6} mm	z	C831
45°	3.5	12.0	54	10	10	C83112.0X45
45°	4.0	16.0	60	12	10	C83116.0X45
45°	5.0	20.0	63	12	10	C83120.0X45
45°	6.3	25.0	67	12	10	C83125.0X45
45°	8.0	32.0	71	16	12	C83132.0X45
60°	5.0	12.0	54	10	10	C83112.0X60
60°	6.3	16.0	60	12	10	C83116.0X60
60°	8.0	20.0	63	12	10	C83120.0X60
60°	10.0	25.0	67	12	10	C83125.0X60
60°	12.5	32.0	71	16	12	C83132.0X60

C710

- Tvarové frézy radiusové
- Концевые фрезы для снятия радиусных фасок
- Frezy do promieni
- Tvarové frézy rádiusové

C710	▪	1.1	1.2	1.3	1.4	2.1	2.2	3.1	3.2	3.3	3.4	4.1	4.2	5.1	5.2	6.1	6.2	6.3	7.1	7.2	7.3
	•	1.5	1.6	2.3	4.3	5.3	6.4	7.4	10.1												

C710	HSS		N	Z 4		$\lambda 0^\circ$ $\gamma 0^\circ$					BS 122/4
------	-----	--	---	--------	--	---------------------------------------	--	--	--	--	-------------

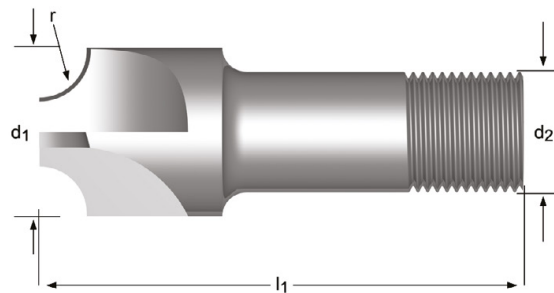

r Inch	d ₁ Ø Inch	d ₂ Ø _{h₈} Inch	d ₂ Ø mm	l ₁ mm	z	C710
1/16	3/8	3/8	9.53	60.5	4	C7101/16
1/8	1/2	1/2	12.70	60.5	4	C7101/8
5/32	9/16	1/2	12.70	60.5	4	C7105/32
3/16	5/8	5/8	15.88	60.5	4	C7103/16
1/4	7/8	5/8	15.88	63.5	4	C7101/4
3/8	1.1/16	1"	25.40	76.0	4	C7103/8
1/2	1.3/8	1"	25.40	82.5	4	C7101/2

- C700**
- Tvarové frézy radiusové
 - Концевые фрезы для снятия радиусных фасок
 - Frezy do promieni
 - Tvarové frézy rádiusové

C700	1.1	1.2	1.3	1.4	1.5	1.6	2.1	2.2	2.3	3.1	3.2	3.3	3.4	4.1	4.2	4.3	5.1	5.2	5.3	6.1	
	6.2	6.3	6.4	7.1	7.2	7.3	7.4	10.1													

C700 HSS-E  N  Z 4-6   $\lambda 0^\circ$ $\gamma 0^\circ$     

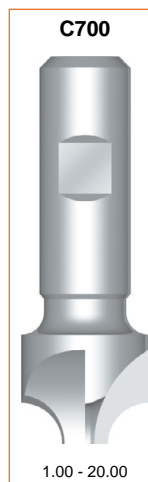
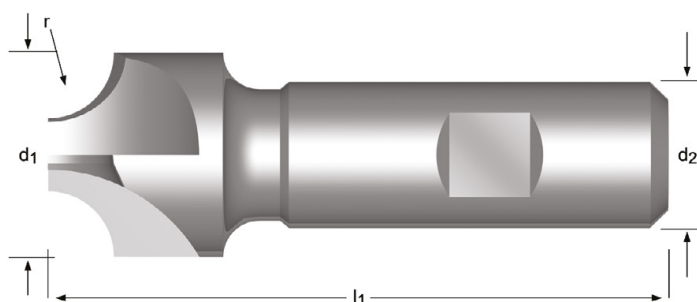

r mm	d ₁ Ø mm	d ₂ Ø _{h₈} mm	l ₁ mm	z	C700
1.00	10	10	60	4	C7001.0
1.50	10	10	60	4	C7001.5
2.00	10	10	60	4	C7002.0
2.50	10	10	60	4	C7002.5
3.00	12	12	60	4	C7003.0
3.50	12	12	60	4	C7003.5
4.00	15	12	60	4	C7004.0
5.00	18	16	70	4	C7005.0
6.00	21	16	70	4	C7006.0
7.00	24	16	70	4	C7007.0
8.00	24	16	70	4	C7008.0
9.00	28	20	85	4	C7009.0
10.00	28	20	85	4	C70010.0
12.00	35	20	100	4	C70012.0
12.50	35	20	100	4	C70012.5
14.00	42	25	100	4	C70014.0
15.00	48	25	105	5	C70015.0
16.00	48	25	105	5	C70016.0
20.00	60	32	115	6	C70020.0

- D200** • Fréza čelní a stranová
• Трехсторонние дисковые фрезы
- D763** • Frez tarczowy trzystronny
• Fréza čelní a stranová

D200; D763	1.1	1.2	1.3	1.4	1.5	1.6	2.1	2.2	2.3	3.1	3.2	3.3	3.4	4.1	4.2	4.3	5.1	5.2
	5.3	6.1	6.2	6.3	6.4	7.1	7.2	7.3	7.4	8.1								

D200	HSS-E			Z 16-30		$\lambda 15^\circ$ $\gamma 10^\circ$			js16		DIN 885A
D763	HSS-E			Z 28-44		$\lambda 15^\circ$ $\gamma 10^\circ$			js16		DIN 885A

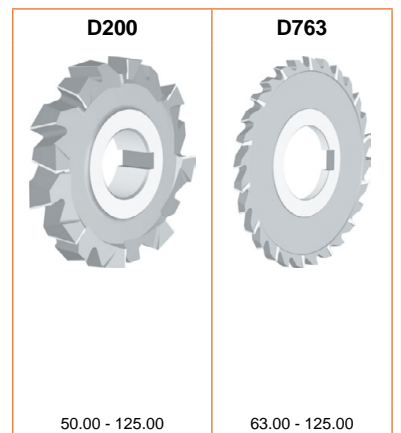
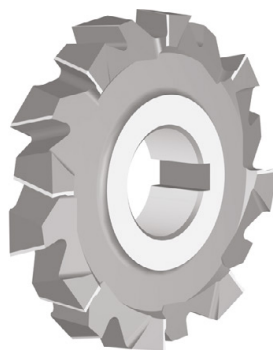
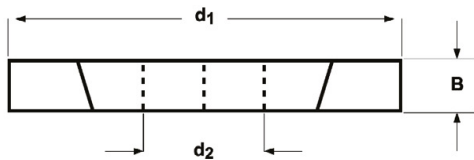

d_1 Ø mm	B mm	d_2 Ø mm	z	D200	D763
50.00	4.0	16	16	D20050.0X4.0	
50.00	5.0	16	16	D20050.0X5.0	
63.00	1.6	22	32		D76363.0X1.6
63.00	2.0	22	32		D76363.0X2.0
63.00	2.5	22	32		D76363.0X2.5
63.00	3.0	22	28		D76363.0X3.0
63.00	3.5	22	28		D76363.0X3.5
63.00	6.0	22	18	D20063.0X6.0	
63.00	8.0	22	18	D20063.0X8.0	
80.00	10.0	27	18	D20080.0X10.0	
80.00	2.0	27	36		D76380.0X2.0
80.00	2.5	27	36		D76380.0X2.5
80.00	3.0	27	32		D76380.0X3.0
80.00	3.5	27	32		D76380.0X3.5
80.00	6.0	27	20	D20080.0X6.0	
80.00	8.0	27	20	D20080.0X8.0	
100.00	10.0	32	22	D200100.0X10.0	
100.00	12.0	32	20	D200100.0X12.0	
100.00	14.0	32	20	D200100.0X14.0	
100.00	16.0	32	20	D200100.0X16.0	
100.00	2.0	32	44		D763100.0X2.0
100.00	3.0	32	40		D763100.0X3.0
100.00	8.0	32	22	D200100.0X8.0	
125.00	10.0	32	24	D200125.0X10.0	
125.00	12.0	32	22	D200125.0X12.0	
125.00	2.0	32	44		D763125.0X2.0
125.00	3.0	32	44		D763125.0X3.0

D745

- Fréza kotoučová, pilka
- Фрезы дисковые отрезные
- Frezy piłkowe do metalu
- Fréza kotúčová, pilka

D745	▪	1.1	1.2	1.3	1.4	3.1	3.2	3.3	6.1	6.2	6.3	7.1	7.2	7.3	8.1	
	•	2.1	2.2													

D745 HSS   Z 28-100  $\gamma 15^\circ$  DIN 1838

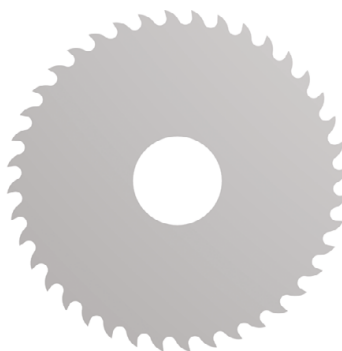
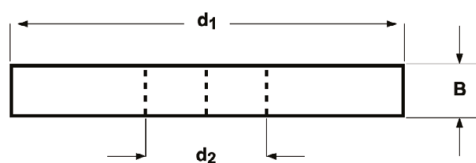

d_1 Ø mm	B mm	d_2 Ø mm	z	D745
50.00	0.5	13	48	D74550.0X.5
50.00	0.6	13	48	D74550.0X.6
50.00	0.8	13	40	D74550.0X.8
50.00	1.0	13	40	D74550.0X1.0
50.00	1.2	13	40	D74550.0X1.2
50.00	1.5	13	32	D74550.0X1.5
50.00	1.6	13	32	D74550.0X1.6
50.00	2.0	13	32	D74550.0X2.0
63.00	0.5	16	64	D74563.0X.5
63.00	0.6	16	48	D74563.0X.6
63.00	0.8	16	48	D74563.0X.8
63.00	1.0	16	48	D74563.0X1.0
63.00	1.2	16	40	D74563.0X1.2
63.00	1.5	16	40	D74563.0X1.5
63.00	1.6	16	40	D74563.0X1.6
63.00	2.0	16	40	D74563.0X2.0
80.00	1.0	22	48	D74580.0X1.0
80.00	1.2	22	48	D74580.0X1.2
80.00	1.5	22	48	D74580.0X1.5
80.00	1.6	22	48	D74580.0X1.6
80.00	2.0	22	40	D74580.0X2.0
80.00	2.5	22	40	D74580.0X2.5
80.00	3.0	22	40	D74580.0X3.0
100.00	1.0	22	64	D745100.0X1.0
100.00	1.2	22	64	D745100.0X1.2
100.00	1.5	22	48	D745100.0X1.5
100.00	1.6	22	48	D745100.0X1.6
100.00	2.0	22	48	D745100.0X2.0
100.00	2.5	22	48	D745100.0X2.5
100.00	3.0	22	40	D745100.0X3.0
100.00	4.0	22	40	D745100.0X4.0
125.00	1.0	22	80	D745125.0X1.0
125.00	1.2	22	64	D745125.0X1.2
125.00	1.5	22	64	D745125.0X1.5
125.00	1.6	22	64	D745125.0X1.6
125.00	2.0	22	64	D745125.0X2.0
125.00	2.5	22	48	D745125.0X2.5
125.00	3.0	22	48	D745125.0X3.0
125.00	4.0	22	48	D745125.0X4.0

d_1 Ø mm	B mm	d_2 Ø mm	z	D745
160.00	1.6	32	80	D745160.0X1.6
160.00	2.0	32	64	D745160.0X2.0
160.00	2.5	32	64	D745160.0X2.5
160.00	3.0	32	64	D745160.0X3.0
160.00	4.0	32	48	D745160.0X4.0
200.00	1.6	32	80	D745200.0X1.6
200.00	2.0	32	80	D745200.0X2.0
200.00	2.5	32	80	D745200.0X2.5
200.00	3.0	32	64	D745200.0X3.0
200.00	4.0	32	64	D745200.0X4.0
250.00	2.0	32	100	D745250.0X2.0
250.00	2.5	32	80	D745250.0X2.5
250.00	3.0	32	80	D745250.0X3.0

D747

- Fréza kotoučová, pilka
- Фрезы дисковые отрезные
- Frezy piłkowe do metalu
- Fréza kotúčová, pilka

D747	▪	1.1	1.2	1.3	1.4	3.1	3.2	3.3	6.1	6.2	6.3	7.1	7.2	7.3	8.1	
	•	2.1	2.2													

D747	HSS			Z 40-200		γ 5°						DIN 1837
------	-----	---	---	-------------	---	-------------	---	---	---	---	---	-------------

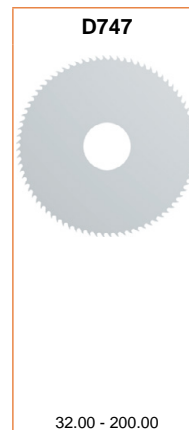
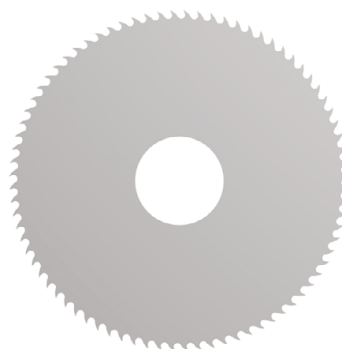
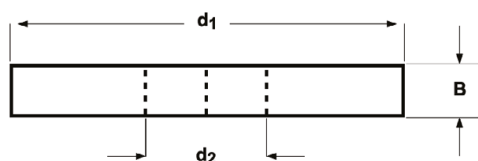

d_1 Ø mm	B mm	d_2 Ø mm	z	D747
32.00	0.3	8	80	D74732.0X.3
32.00	0.4	8	80	D74732.0X.4
32.00	0.5	8	80	D74732.0X.5
32.00	0.6	8	64	D74732.0X.6
32.00	0.8	8	64	D74732.0X.8
32.00	1.0	8	64	D74732.0X1.0
32.00	1.2	8	48	D74732.0X1.2
32.00	1.5	8	48	D74732.0X1.5
32.00	1.6	8	48	D74732.0X1.6
32.00	2.0	8	48	D74732.0X2.0
40.00	0.3	10	100	D74740.0X.3
40.00	0.4	10	100	D74740.0X.4
40.00	0.5	10	80	D74740.0X.5
40.00	0.6	10	80	D74740.0X.6
40.00	0.8	10	80	D74740.0X.8
40.00	1.0	10	64	D74740.0X1.0
40.00	1.2	10	64	D74740.0X1.2
40.00	1.5	10	64	D74740.0X1.5
40.00	1.6	10	64	D74740.0X1.6
40.00	2.0	10	48	D74740.0X2.0
50.00	0.3	13	128	D74750.0X.3
50.00	0.4	13	100	D74750.0X.4
50.00	0.5	13	100	D74750.0X.5
50.00	0.6	13	100	D74750.0X.6
50.00	0.8	13	80	D74750.0X.8
50.00	1.0	13	80	D74750.0X1.0
50.00	1.2	13	80	D74750.0X1.2
50.00	1.5	13	64	D74750.0X1.5
50.00	1.6	13	64	D74750.0X1.6
50.00	2.0	13	64	D74750.0X2.0
50.00	2.5	13	64	D74750.0X2.5
50.00	3.0	13	48	D74750.0X3.0
63.00	0.5	16	128	D74763.0X.5
63.00	0.6	16	100	D74763.0X.6
63.00	0.8	16	100	D74763.0X.8
63.00	1.0	16	100	D74763.0X1.0
63.00	1.2	16	80	D74763.0X1.2

d₁ ∅ mm	B mm	d₂ ∅ mm	z	D747
63.00	1.5	16	80	D74763.0X1.5
63.00	1.6	16	80	D74763.0X1.6
63.00	2.0	16	80	D74763.0X2.0
63.00	2.5	16	64	D74763.0X2.5
63.00	3.0	16	64	D74763.0X3.0
63.00	4.0	16	64	D74763.0X4.0
80.00	0.5	22	128	D74780.0X.5
80.00	0.6	22	128	D74780.0X.6
80.00	0.8	22	128	D74780.0X.8
80.00	1.0	22	100	D74780.0X1.0
80.00	1.2	22	100	D74780.0X1.2
80.00	1.5	22	100	D74780.0X1.5
80.00	1.6	22	100	D74780.0X1.6
80.00	2.0	22	80	D74780.0X2.0
80.00	2.5	22	80	D74780.0X2.5
80.00	3.0	22	80	D74780.0X3.0
80.00	4.0	22	64	D74780.0X4.0
100.00	0.5	22	160	D747100.0X.5
100.00	0.6	22	160	D747100.0X.6
100.00	0.8	22	128	D747100.0X.8
100.00	1.0	22	128	D747100.0X1.0
100.00	1.2	22	128	D747100.0X1.2
100.00	1.5	22	100	D747100.0X1.5
100.00	1.6	22	100	D747100.0X1.6
100.00	2.0	22	100	D747100.0X2.0
100.00	2.5	22	100	D747100.0X2.5
100.00	3.0	22	80	D747100.0X3.0
100.00	4.0	22	80	D747100.0X4.0
125.00	1.0	22	160	D747125.0X1.0
125.00	1.2	22	128	D747125.0X1.2
125.00	1.5	22	128	D747125.0X1.5
125.00	1.6	22	128	D747125.0X1.6
125.00	2.0	22	128	D747125.0X2.0
125.00	2.5	22	100	D747125.0X2.5
125.00	3.0	22	100	D747125.0X3.0
125.00	4.0	22	100	D747125.0X4.0
160.00	1.0	32	160	D747160.0X1.0
160.00	1.2	32	160	D747160.0X1.2
160.00	1.5	32	160	D747160.0X1.5
160.00	1.6	32	160	D747160.0X1.6
160.00	2.0	32	128	D747160.0X2.0
160.00	2.5	32	128	D747160.0X2.5
160.00	3.0	32	128	D747160.0X3.0
160.00	4.0	32	100	D747160.0X4.0
160.00	5.0	32	100	D747160.0X5.0
200.00	1.0	32	200	D747200.0X1.0
200.00	1.2	32	200	D747200.0X1.2
200.00	2.0	32	160	D747200.0X2.0
200.00	3.0	32	128	D747200.0X3.0

- D752** • Fréza kotoučová, pilka
• Фрезы дисковые отрезные
- D753** • Frezy piłkowe do metalu
• Fréza kotúčová, pilka

D752; D753	▪	1.1	1.2	1.3	1.4	3.1	3.2	3.3	6.1	6.2	6.3	7.1	7.2	7.3	8.1	
	•	2.1	2.2													

D752	HSS			Z 80-180		$\gamma 18^\circ$					
D753	HSS			Z 100-140		$\gamma 18^\circ$					

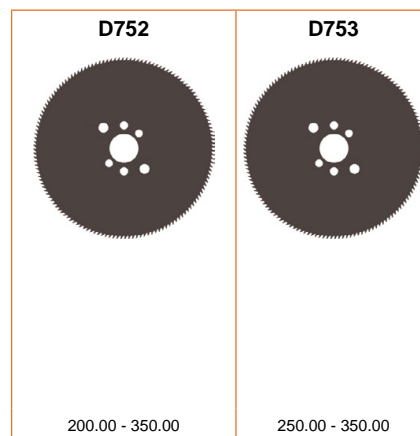
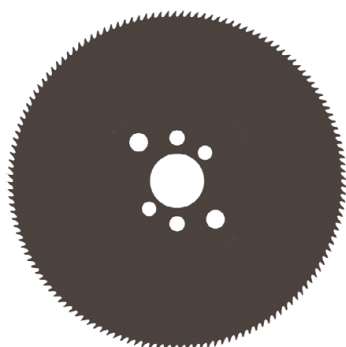
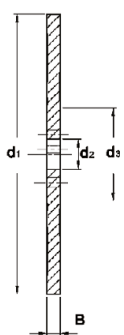
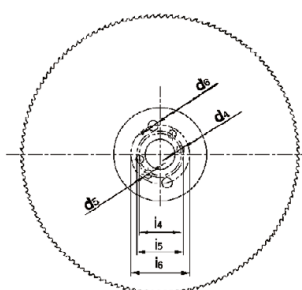

d_1 Ø mm	B mm	d_2 Ø mm	z	P mm	d_3 Ø mm	d_4 Ø mm	i_4 mm	d_5 Ø mm	i_5 mm	d_6 Ø mm	i_6 mm	D752	D753
250	2.0	32	100	8	100	8	45	9	50	11	63		D753250.0X2.0
250	2.0	32	128	6	100	8	45	9	50	11	63	D752250.0X2.0X128	
275	2.5	32	110	8	100	8	45	9	50	11	63	D752275.0X2.5X110	
300	2.5	32	120	8	100	8	45	9	50	11	63	D752300.0X2.5X160	D753300.0X2.5
300	2.5	32	160	6	100	8	45	9	50	11	63		
315	2.5	32	120	8	100	8	45	9	50	11	63		D753315.0X2.5
315	2.5	32	160	6	100	8	45	9	50	11	63	D752315.0X2.5X160	
350	2.5	32	140	8	120	8	45	9	50	11	63		D753350.0X2.5
350	2.5	32	180	6	120	8	45	9	50	11	63	D752350.0X2.5X180	

- D750** • Fréza kotoučová, pilka
• Фрезы дисковые отрезные
- D751** • Frezy pilkowe do metalu
• Fréza kotúčová, pilka

D750; D751	▪	1.1	1.2	1.3	1.4	3.1	3.2	3.3	6.1	6.2	6.3	7.1	7.2	7.3	8.1	
	•	2.1	2.2													

D750	HSS			Z 128-220		$\gamma 18^\circ$					
D751	HSS			Z 160-350		$\gamma 18^\circ$					

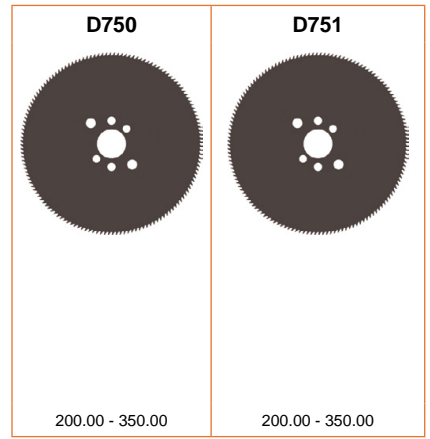
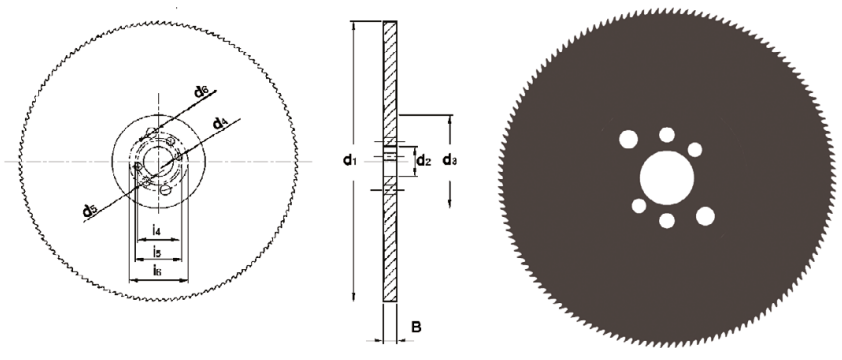

d ₁ Ø mm	B mm	d ₂ Ø mm	z	P mm	d ₃ Ø mm	d ₄ Ø mm	i ₄ mm	d ₅ Ø mm	i ₅ mm	d ₆ Ø mm	i ₆ mm	D750	D751
200	1.8	32	130	5	100	8	45	9	50	11	63	D750200.0X1.8	
200	1.8	32	160	4	100	8	45	9	50	11	63		D751200.0X1.8X160
200	1.8	32	200	3	100	8	45	9	50	11	63		D751200.0X1.8X200
225	2.0	32	140	5	100	8	45	9	50	11	63	D750225.0X2.0	
225	2.0	32	180	4	100	8	45	9	50	11	63		D751225.0X2.0X180
225	2.0	32	220	3	100	8	45	9	50	11	63		D751225.0X2.0X220
250	2.0	32	160	5	100	8	45	9	50	11	63	D750250.0X2.0	
250	2.0	32	200	4	100	8	45	9	50	11	63		D751250.0X2.0X200
250	2.0	32	250	3	100	8	45	9	50	11	63		D751250.0X2.0X250
275	2.5	32	180	5	100	8	45	9	50	11	63	D750275.0X2.5	
275	2.5	32	220	4	100	8	45	9	50	11	63		D751275.0X2.5X220
275	2.5	32	280	3	100	8	45	9	50	11	63		D751275.0X2.5X280
300	2.5	32	180	5	100	8	45	9	50	11	63	D750300.0X2.5	
300	2.5	32	220	4	100	8	45	9	50	11	63		D751300.0X2.5X220
300	2.5	32	300	3	100	8	45	9	50	11	63		D751300.0X2.5X300
315	2.5	32	200	5	100	8	45	9	50	11	63	D750315.0X2.5	
315	2.5	32	240	4	100	8	45	9	50	11	63		D751315.0X2.5X240
315	2.5	32	320	3	100	8	45	9	50	11	63		D751315.0X2.5X320
350	2.5	32	220	5	120	8	45	9	59	11	63	D750350.0X2.5	
350	2.5	32	280	4	120	8	45	9	50	11	63		D751350.0X2.5X280
350	2.5	32	350	3	120	8	45	9	50	11	63		D751350.0X2.5X350

- D400**
- Nástrčné frézy
 - Насадные торцевые фрезы
- D420**
- Frezy nasadzane walcowo-czołowe
 - Fréza nástrčná, valcová čelná

D400	▪	1.1	1.2	1.3	1.4	2.1	2.3	3.1	3.2	3.3	3.4	4.1	5.1	6.1	6.2	6.3	7.2	7.3			
	•	1.5	1.6	2.2	4.2	4.3	5.2	5.3	6.4	7.1	7.4	8.1	8.2	8.3	10.1						
D420	▪	1.1	1.2	1.3	1.4	1.5	1.6	2.1	2.2	2.3	3.1	3.2	3.3	3.4	4.1	4.2	4.3	5.1	5.2	5.3	6.1
		6.2	6.3	6.4	7.2	7.3	7.4	8.1	10.1												
	•	7.1	8.2	8.3																	

D400	HSS-E		N	Z 8-12		$\lambda 30^\circ$ $\gamma 12^\circ$		js16		DIN 1880
D420	HSS-E		N	Z 8-12		$\lambda 30^\circ$ $\gamma 12^\circ$	TiCN	js16		DIN 1880

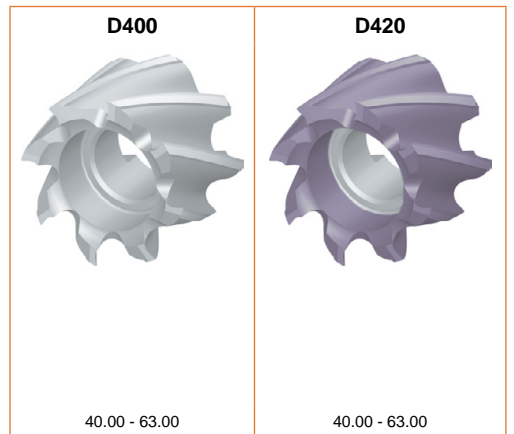
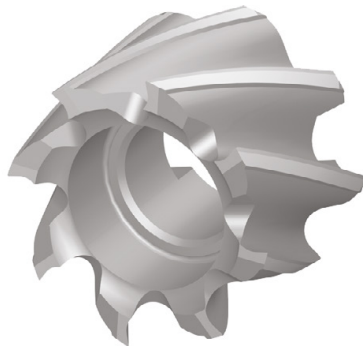
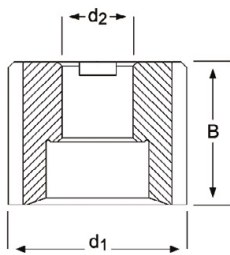

d_1 Ø mm	B mm	d_2 Ø mm	z	D400	D420
40.00	32	16	8	D40040.0	D42040.0
50.00	36	22	8	D40050.0	D42050.0
63.00	40	27	8	D40063.0	D42063.0

- D402** • Fréza nástrčná, hrubovací
 • Черновые насадные торцевые фрезы
- D422** • Frezy nasadzane walcowo-czołowe do obróbki zgrubnej
 • Fréza nástrčná, valcová čelná

D402	▪	1.1	1.2	1.3	1.4	2.1	2.3	3.1	3.2	3.3	3.4	4.1	5.1	6.1	6.2	6.3	7.2	7.3			
	•	1.5	1.6	2.2	4.2	4.3	5.2	5.3	6.4	7.1	7.4	8.1	8.2	8.3	10.1						
D422	▪	1.1	1.2	1.3	1.4	1.5	1.6	2.1	2.2	2.3	3.1	3.2	3.3	3.4	4.1	4.2	4.3	5.1	5.2	5.3	6.1
		6.2	6.3	6.4	7.2	7.3	7.4	8.1	10.1												
	•	7.1	8.2	8.3																	

D402	HSS-E		NR	Z 6-10		$\lambda 30^\circ$ $\gamma 12^\circ$			js16		DIN 1880
D422	HSS-E		NR	Z 6-10		$\lambda 30^\circ$ $\gamma 12^\circ$		TiCN	js16		DIN 1880

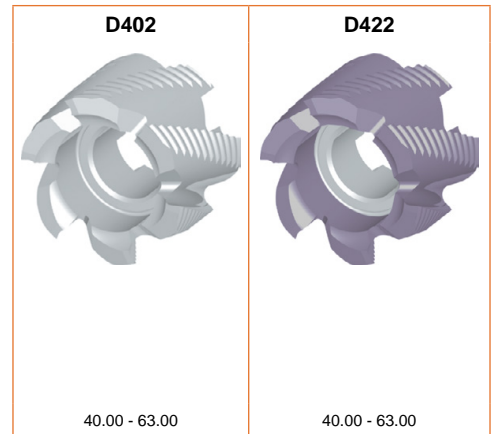
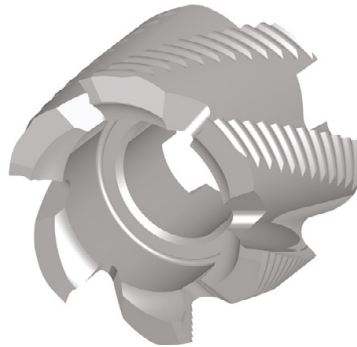
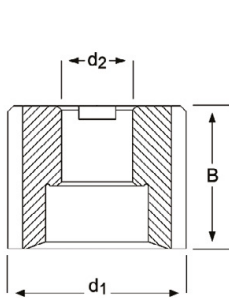

d_1 Ø mm	B mm	d_2 Ø mm	z	D402	D422
40.00	32	16	6	D40240.0	D42240.0
50.00	36	22	6	D40250.0	D42250.0
63.00	40	27	8	D40263.0	D42263.0

P601	502	P721	520	P817	517
P605	506	P801	501	P819	518
P607	508	P801C	501	P821	519
P609	510	P803	503	P821C	519
P611	512	P803C	503	P823	521
P613	514	P805	505	P825	522
P615	516	P805C	505	P831	502
P621	520	P807	507	P833	504
P701	502	P807C	507	P835	506
P703	504	P809	509	P837	508
P705	506	P811	511	P841	512
P707	508	P811C	511	P842	520
P709	510	P813	513	P843	523
P711	512	P813C	513	P844	524
P713	514	P815	515	P880	525
P715	516	P815C	515	P890	526

495 - 526

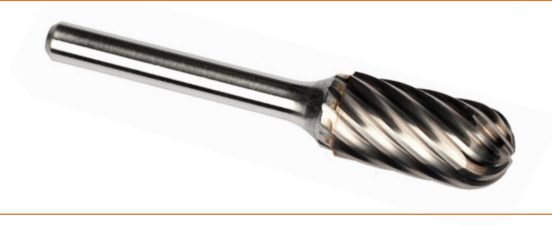

Materiál	Материал	Materiał	Materiál
Použití	Тип борфрезы	Zastosowanie	Použitie
čelní břit	Применение	Uzębienie czołowe	čelný brit
Povlak	Торцевая заточка	Pokrycie	Povlak
Vrcholový úhel	Покрытие	Kąt ostrza	Vrcholový uhol
Typ	Угол при вершине	Typ	Typ
Standard	Геометрия	Standard	Štandard
<ul style="list-style-type: none"> ■ vynikající ● dobrý Příklad 10 = řezná rychlost (m/min) +/- 10%	Основное применение Возможное применение Пример: 10 = Скорость резания в м/мин +/- 10%	Najlepsze zastosowanie Dobre zastosowanie Na przykład 10 = prędkość skrawania (m/min) +/- 10%	Vynikajúce Dobré Příklad 10 = rezná rýchlosť (m/min) +/- 10%
Kód	Код	Kod	Kód
Rozměrová řada	Ассортимент	Zakres	Rozsah rozmerov

AMG	Česky	Русский	Polski	Slovensky
1.1	magneticky měkká	Автоматная сталь	magnetyczna miękka	Magneticky mäkká oceľ
1.2	konstrukční uhlíkatá	Низкоуглеродистая сталь	konstrukcyjna do nawęglania	Konstruktčná oceľ, uhlíková
1.3	uhlíkatá	Углеродистая нелегированная сталь	węglowa	Uhlíková oceľ
1.4	legovaná	Легированная сталь	stopowa	Legovaná oceľ
1.5	legovaná, tvrzená a temperovaná	Легированная сталь после отжига	stopowa-hartowana i odpuszczana	Legovaná oceľ, tvrdená a temperovaná
1.6	legovaná, tvrzená a temperovaná	Высоколегированная сталь после отжига	stopowa-hartowana i odpuszczana	Legovaná oceľ, tvrdená a temperovaná
1.7	legovaná, tvrzená	Легированная закаленная сталь	stopowa-hartowana	Legovaná oceľ tvrdená
1.8	legovaná, tvrzená	Легированная закаленная сталь	stopowa-hartowana	Legovaná oceľ tvrdená, oceľ odolná oproti opotrebovaniu
2.1	automatová	Ферритная нержавеющая сталь	automatowa	Automatová nehrdzavejúca oceľ
2.2	austenitická	Аустенитная нержавеющая сталь	austenityczna	Austenická
2.3	feritická+austenitická	Ферритно-аустенитная нержавеющая сталь	ferytyczna+austenityczna	Feriticko austenitická nehr. oceľ (Duplex)
2.4	precipitačně tvrzená	Сталь дисперсионного твердения	Utwardzane wydzieleniowo	Tvrdená nehr. oceľ
3.1	lamelární	Серый чугуn	szare	Sivá liatina
3.2	lamelární	Ковкий чугуn	szare	Sivá liatina
3.3	nodulární	Высокопрочный чугуn	sferoidalne ciagliwe	Tvárna liatina
3.4	nodulární	Высокопрочный чугуn	sferoidalne ciagliwe	Tvárna liatina
4.1	čistý	Технически чистый титан	niestopowy	Čistý titán
4.2	slitiny	Титановые сплавы	stopy tytanu	Zliatiny titánu
4.3	slitiny	Титановые сплавы	stopy tytanu	Zliatiny titánu
5.1	čistý	Технически чистый никель	niestopowy	Čistý nikel
5.2	slitiny	Никелевые сплавы	stopy niklu	Zliatiny niklu
5.3	slitiny	Никелевые сплавы	stopy niklu	Zliatiny niklu
6.1	bronz	Технически чистая медь	niestopowa	Bronz
6.2	β - mosaz, bronz	Бронза	Mosiądz-β, brąz	β - mosadz, bronz
6.3	bronz mosaz	Латунь	Mosiądz CuZn	Mosadz, bronz
6.4	bronz vysokopevnostní	Высокопрочная бронза	Brąz o wysokiej wytrzymałości	Vysokopevnostný bronz
7.1	Al, Mg, tvářené	Технически чистый алюминий/магний	Al.,Mg, niestopowe	Al, Mg, tvárnený (čistý)
7.2	Al slitiny, Si<0.5%	Сплавы Al с содержанием Si<0.5%	Al. Stopowe, Si<0,5%	Al zliatiny, Si<0,5%
7.3	Al slitiny, Si>0.5%<10%	Сплавы Al с содержанием 0.5%<Si<10%	Al. Stopowe, Si>0,5%<10%	Al zliatiny, Si>0,5%<10%
7.4	Al slitiny, Si>10%	Сплавы Al с содержанием Si>10%	Al. Stopowe, Si>10%	Al zliatiny, Si>10%
8.1	termoplasty	Термопластики	Tworzywa termoplastyczne	Termoplasty
8.2	termosety	Терморективные полимеры	Tworzywa termoutwardzalne	Termosety
8.3	zpevněné plasty	Армированные полимеры	Zbrojone tworzywa sztuczne	Spevnené plasty
9.1	cermet (keramika)	Металлокерамика	Cermetale	Cermet (kov-keramika)
10.1	standardni grafit	Технический графит	Grafit standartowy	Grafit

	HM	HM	HM	HM	HM	HM	HM	HM	HM	HM	HM	HM	HM	HM	HM		
	A	A	A	A	A	B	B	B	B	C	C	C	C	C	D	D	
		TiAlN					TiAlN									TiAlN	
	DC	DC	ST	VA	AL	DC	DC	ST	AL	DC	DC	ST	VA	AL	DC	DC	
	P801	P801C	P701	P601	P831	P803	P803C	P703	P833	P805	P805C	P705	P605	P835	P807	P807C	
	3.00 - 16.00	3.00 - 12.70	6.00 - 12.70	3.00 - 12.70	6.00 - 12.70	3.00 - 16.00	3.00 - 12.70	6.00 - 12.70	6.00 - 12.70	3.00 - 16.00	3.00 - 12.70	6.00 - 12.70	3.00 - 12.70	6.00 - 12.70	3.00 - 16.00	3.00 - 12.70	
AMG	501	501	502	502	502	503	503	504	504	505	505	506	506	506	507	507	ISO
1.1	■	■	■			■	■	■		■	■	■			■	■	P 1
1.2	■	■	■			■	■	■		■	■	■			■	■	P 1
1.3	■	■	■			■	■	■		■	■	■			■	■	P 2
1.4	■	■	■			■	■	■		■	■	■			■	■	P 3
1.5	■	■	■			■	■	■		■	■	■			■	■	P 4
1.6	■	■	■			■	■	■		■	■	■			■	■	H 1
1.7	■	■	■			■	■	■		■	■	■			■	■	H 3
1.8	■	■	■			■	■	■		■	■	■			■	■	H 4
2.1	■	■	■	■	●	■	■	■	●	■	■	■	■	■	■	■	M 1
2.2	■	■	■	■		■	■	■		■	■	■	■	■	■	■	M 3
2.3	■	■	■	■		■	■	■		■	■	■	■	■	■	■	M 2
2.4	■	■	■	■		■	■	■		■	■	■	■	■	■	■	S 2
3.1	■	■	■	■		■	■	■		■	■	■	■	■	■	■	K 1
3.2	■	■	■	■		■	■	■		■	■	■	■	■	■	■	K 2
3.3	■	■	■	■		■	■	■		■	■	■	■	■	■	■	K 3
3.4	■	■	■	■		■	■	■		■	■	■	■	■	■	■	K 4
4.1	■	■	■	■	●	■	■	■	●	■	■	■	■	■	■	■	S 1
4.2	■	■	■	■		■	■	■		■	■	■	■	■	■	■	S 2
4.3	■	■	■	■		■	■	■		■	■	■	■	■	■	■	S 3
5.1	■	■	■	■	●	■	■	■	●	■	■	■	■	■	■	■	S 1
5.2	■	■	■	■		■	■	■		■	■	■	■	■	■	■	S 2
5.3	■	■	■	■		■	■	■		■	■	■	■	■	■	■	S 3
6.1	●	●	■	■		■	■	■	●	■	■	■	■	■	■	■	N 3
6.2	■	■	■	■	●	■	■	■	●	■	■	■	■	■	■	■	N 4
6.3	■	■	■	■		■	■	■		■	■	■	■	■	■	■	N 3
6.4	■	■	■	■		■	■	■		■	■	■	■	■	■	■	N 4
7.1				■				■					■				N 1
7.2				■				■					■				N 1
7.3				■				■					■				N 1
7.4				■				■					■				N 2
8.1				■				■					■				O
8.2				■				■					■				O
8.3				■				■					■				O
9.1	■	■				■	■			■	■			■	■		H
10.1																	O

	HM	HM	HM	HM	HM	HM	HM	HM	HM	HM	HM	HM	HM	HM	HM	HM	
	D	D	D	E	E	E	F	F	F	F	F	G	G	G	G	H	
	ST	VA	AL	DC	ST	VA	DC	DC	ST	VA	AL	DC	DC	ST	VA	DC	
	P707	P607	P837	P809	P709	P609	P811	P811C	P711	P611	P841	P813	P813C	P713	P613	P815	
	6.00 - 12.70	3.00 - 12.70	6.00 - 12.70	3.00 - 16.00	12.70	8.00 - 12.70	3.00 - 16.00	3.00 - 12.70	6.00 - 12.70	3.00 - 12.70	6.00 - 12.70	3.00 - 16.00	3.00 - 12.70	6.00 - 12.70	6.00 - 12.70	3.00 - 16.00	
AMG	508	508	508	509	510	510	511	511	512	512	512	513	513	514	514	515	ISO
1.1	■			■	■		■	■	■			■	■	■		■	P 1
1.2	■			■	■		■	■	■			■	■	■		■	P 1
1.3	■			■	■		■	■	■			■	■	■		■	P 2
1.4	■			■	■		■	■	■			■	■	■		■	P 3
1.5	■			■	■		■	■	■			■	■	■		■	P 4
1.6	■			■	■		■	■	■			■	■	■		■	H 1
1.7				■	■		■	■	■			■	■	■		■	H 3
1.8				■	■		■	■	■			■	■	■		■	H 4
2.1		■	●	■		■	■	■		■	●	■	■		■	■	M 1
2.2		■		■		■	■	■		■		■	■		■	■	M 3
2.3		■		■		■	■	■		■		■	■		■	■	M 2
2.4		■		■		■	■	■		■		■	■		■	■	S 2
3.1				■		■	■	■		■		■	■		■	■	K 1
3.2				■		■	■	■		■		■	■		■	■	K 2
3.3				■		■	■	■		■		■	■		■	■	K 3
3.4				■		■	■	■		■		■	■		■	■	K 4
4.1			●	■		■	■	■		■	●	■	■		■	■	S 1
4.2				■		■	■	■		■		■	■		■	■	S 2
4.3				■		■	■	■		■		■	■		■	■	S 3
5.1			●	■		■	■	■		■	●	■	■		■	■	S 1
5.2				■		■	■	■		■		■	■		■	■	S 2
5.3				■		■	■	■		■		■	■		■	■	S 3
6.1				■		■	●	●		■		■	●		■	●	N 3
6.2			●	■		■	■	■		■	●	■	■		■	■	N 4
6.3				■		■	■	■		■		■	■		■	■	N 3
6.4				■		■	■	■		■		■	■		■	■	N 4
7.1		■										■					N 1
7.2		■										■					N 1
7.3		■										■					N 1
7.4		■										■					N 2
8.1		■										■					O
8.2		■										■					O
8.3		■										■					O
9.1				■			■	■				■	■			■	H
10.1																	O

	HM	HM	HM	HM	HM	HM	HM	HM	HM	HM	HM	HM	HM	HM	
	H	H	H	J	K	L	L	L	L	L	M	N			
	TiAIN						TiAIN								
				60°	90°								135°	180°	
	DC	ST	VA	DC	DC	DC	DC	ST	VA	AL	DC	DC	GRP	GRP	
	P815C	P715	P615	P817	P819	P821	P821C	P721	P621	P842	P823	P825	P843	P844	
	8.00 - 12.70	8.00 - 12.70	8.00 - 12.70	3.00 - 16.00	3.00 - 16.00	3.00 - 16.00	3.00 - 12.70	10.00 - 12.70	8.00 - 12.70	6.00 - 12.70	3.00 - 16.00	3.00 - 16.00	3.00 - 8.00	3.00 - 8.00	
AMG		516	516	517	518	519	519	520	520	520	521	522	523	524	ISO
1.1	■	■		■	■	■	■	■			■	■			P 1
1.2	■	■		■	■	■	■	■			■	■			P 1
1.3	■	■		■	■	■	■	■			■	■			P 2
1.4	■	■		■	■	■	■	■			■	■			P 3
1.5	■	■		■	■	■	■	■			■	■			P 4
1.6	■	■		■	■	■	■	■			■	■			H 1
1.7	■			■	■	■	■	■			■	■			H 3
1.8	■			■	■	■	■	■			■	■			H 4
2.1	■		■	■	■	■	■	■	■	●	■	■			M 1
2.2	■		■	■	■	■	■	■	■		■	■			M 3
2.3	■		■	■	■	■	■	■	■		■	■			M 2
2.4	■		■	■	■	■	■	■	■		■	■			S 2
3.1	■			■	■	■	■	■			■	■			K 1
3.2	■			■	■	■	■	■			■	■			K 2
3.3	■			■	■	■	■	■			■	■			K 3
3.4	■			■	■	■	■	■			■	■			K 4
4.1	■			■	■	■	■	■		●	■	■			S 1
4.2	■			■	■	■	■	■			■	■			S 2
4.3	■			■	■	■	■	■			■	■			S 3
5.1	■			■	■	■	■	■		●	■	■			S 1
5.2	■			■	■	■	■	■			■	■			S 2
5.3	■			■	■	■	■	■			■	■			S 3
6.1	●			●	●	●	●	●			●	●			N 3
6.2	■			■	■	■	■	■		●	■	■			N 4
6.3	■			■	■	■	■	■			■	■			N 3
6.4	■			■	■	■	■	■			■	■			N 4
7.1										■					N 1
7.2										■					N 1
7.3										■					N 1
7.4										■					N 2
8.1										■			■		O
8.2										■			■		O
8.3										■			■		O
9.1	■			■	■	■	■			■	■				H
10.1															O



P880
Set



P890
Set

AMG	525	526	ISO
1.1			P 1
1.2			P 1
1.3			P 2
1.4			P 3
1.5			P 4
1.6			H 1
1.7			H 3
1.8			H 4
2.1			M 1
2.2			M 3
2.3			M 2
2.4			S 2
3.1			K 1
3.2			K 2
3.3			K 3
3.4			K 4
4.1			S 1
4.2			S 2
4.3			S 3
5.1			S 1
5.2			S 2
5.3			S 3
6.1			N 3
6.2			N 4
6.3			N 3
6.4			N 4
7.1			N 1
7.2			N 1
7.3			N 1
7.4			N 2
8.1			O
8.2			O
8.3			O
9.1			H
10.1			O

AL

DC

RPM / min

AMG	ISO	d ₁ Ø mm							
		3	6	8	10	12	16	20	
1.1 - 1.5	P	64 000	32 000	24 000	20 000	16 000	12 000	10 000	min
		83 000	42 000	32 000	25 000	21 000	16 000	13 000	max
1.6 - 1.8	H	51 000	26 000	20 000	16 000	13 000	10 000	8 000	min
		71 000	36 000	27 000	22 000	18 000	14 000	11 000	max
2	M	45 000	23 000	17 000	14 000	12 000	9 000	7 000	min
		64 000	32 000	24 000	20 000	16 000	12 000	10 000	max
3	K	58 000	29 000	22 000	19 000	15 000	11 000	9 000	min
		77 000	39 000	29 000	23 000	20 000	15 000	12 000	max
4	S 1	45 000	23 000	17 000	14 000	12 000	9 000	7 000	min
		58 000	29 000	22 000	18 000	15 000	11 000	9 000	max
5	S 1	45 000	23 000	17 000	14 000	12 000	9 000	7 000	min
		58 000	29 000	22 000	18 000	15 000	11 000	9 000	max
6	N	64 000	32 000	24 000	20 000	16 000	12 000	10 000	min
		71 000	36 000	27 000	22 000	18 000	14 000	11 000	max
7	N	71 000	36 000	27 000	22 000	18 000	14 000	11 000	min
		96 000	48 000	36 000	29 000	24 000	18 000	15 000	max
8	O	77 000	39 000	29 000	23 000	20 000	15 000	12 000	min
		96 000	48 000	36 000	29 000	24 000	18 000	15 000	max

ST

AMG	ISO		d ₁ Ø mm			
			3	6	10	12
1	P	Max	100 000	65 000	55 000	35 000
		Low	60 000	45 000	30 000	20 000
		High	80 000	60 000	40 000	30 000

VA

AMG	ISO		d ₁ Ø mm			
			3	6	10	12
2	M	Max	100 000	65 000	55 000	35 000
		Low	60 000	30 000	20 000	15 000
		High	80 000	45 000	30 000	22 000

GRP

AMG	ISO		d ₁ Ø mm					
			2	3	4	6	10	12
8	O	Low	40 000	25 000	20 000	20 000	15 000	10 000
		High	45 000	30 000	25 000	25 000	20 000	22 000

P801

- Technické fréza - válcová bez čelního břitu
- Борфрезы - цилиндрические без торцевой заточки
- Pilnik obrotowy - cylindryczny bez uzębienia czołowego
- Technická fréza - Valcová bez čelného britu

Nad průměr 6,00 mm pájené.
Паяный хвостовик для фрез более 6 мм
Lutowany powyżej 6,00 mm
Nad priemer 6,00 mm spájkované.

P801C

P801; P801C	▪	1.1	1.2	1.3	1.4	1.5	1.6	1.7	1.8	2.1	2.2	2.3	2.4	3.1	3.2	3.3	3.4	4.1	4.2
		4.3	5.1	5.2	5.3	6.2	6.3	6.4	9.1										
	•	6.1																	

P801	HM	A					DC	
P801C	HM	A			TAIN		DC	

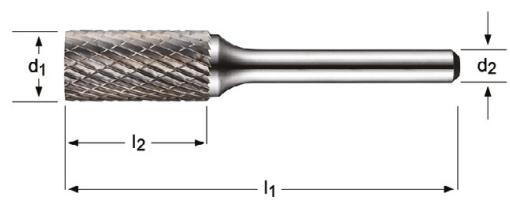

d_1 \varnothing mm	d_2 $\varnothing h_7$ mm	l_2 mm	l_1 mm	P801	P801C
3.00	3	14	38	P8013.0X3.0 ¹⁾	P801C3.0X3.0 ¹⁾
6.30	3	12.7	45	P8016.3X3.0	
6.00	6	18	50	P8016.0X6.0 ¹⁾	P801C6.0X6.0 ¹⁾
8.00	6	19	64	P8018.0X6.0	P801C8.0X6.0
9.60	6	19	64	P8019.6X6.0	P801C9.6X6.0
12.70	6	25	70	P80112.7X6.0	P801C12.7X6.0
16.00	6	25	70	P80116.0X6.0	

¹⁾ d2 tolerance h6 / d2 с допуском по h6 / d2 tolerancja h6 / d2 tolerancia h6

- | | | |
|-------------|---|--------------------------------------|
| P701 | • Technické fréza - válcová bez čelního břítu | Nad průměr 6,00 mm pájené. |
| P601 | • Борфрезы - цилиндрические без торцевой заточки | Паяный хвостовик для фрез более 6 мм |
| P831 | • Piłnik obrotowy - cylindryczny bez użębenia czołowego | Lutowany powyżej 6,00 mm |
| | • Technická fréza - Valcová bez čelného břítu | Nad priemer 6,00 mm spájkované. |

P701	▪	1.1	1.2	1.3	1.4	1.5	1.6	
P601	▪	2.1	2.2	2.3	2.4			
P831	▪	7.1	7.2	7.3	7.4	8.1	8.2	8.3
	•	2.1	4.1	5.1	6.2			

P701	HM	A				ST	
P601	HM	A				VA	
P831	HM	A				AL	

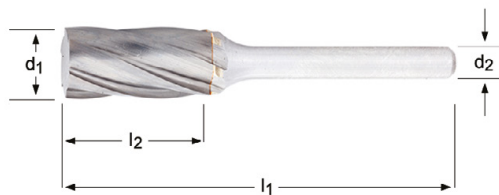

P701	P601	P831
6.00 - 12.70	3.00 - 12.70	6.00 - 12.70
P701	P601	P831
	P6013.0X3.0 ¹⁾	
	P6016.3X3.0	
P7016.0X6.0 ¹⁾	P6016.0X6.0 ¹⁾	P8316.0X6.0 ¹⁾
P7018.0X6.0	P6018.0X6.0	
P7019.6X6.0	P6019.6X6.0	P8319.6X6.0
P70112.7X6.0	P60112.7X6.0	P83112.7X6.0

d_1 Ø mm	d_2 Ø _{h7} mm	l_2 mm	l_1 mm
3.00	3	14	38
6.30	3	12.7	45
6.00	6	18	50
8.00	6	19	64
9.60	6	19	64
12.70	6	25	70

P803

- Technická fréza - válcová s čelním břitem
- Борфрезы - цилиндрические с торцевой заточкой
- Pilnik obrotowy - cylindryczny z uzębieniem czołowym
- Technická fréza - valcová s čelným břitom

Nad průměr 6,00 mm pájené.
 Паяный хвостовик для фрез более 6 мм
 Lutowany powyżej 6,00 mm
 Nad priemer 6,00 mm spájkované.

P803C

P803; P803C

1.1	1.2	1.3	1.4	1.5	1.6	1.7	1.8	2.1	2.2	2.3	2.4	3.1	3.2	3.3	3.4	4.1	4.2
4.3	5.1	5.2	5.3	6.2	6.3	6.4	9.1										
6.1																	

P803

HM	B				DC			
							525	526

P803C

HM	B			TiAlN	DC		
							525



d_1 Ø mm	d_2 Ø _{h7} mm	l_2 mm	l_1 mm	P803	P803C
3.00	3	14	38	P8033.0X3.0 ¹⁾	P803C3.0X3.0 ¹⁾
6.30	3	12.7	45	P8036.3X3.0	
6.00	6	18	50	P8036.0X6.0 ¹⁾	P803C6.0X6.0 ¹⁾
8.00	6	19	64	P8038.0X6.0	P803C8.0X6.0
9.60	6	19	64	P8039.6X6.0	P803C9.6X6.0
12.70	6	25	70	P80312.7X6.0	P803C12.7X6.0
16.00	6	25	70	P80316.0X6.0	

¹⁾ d2 tolerance h6 / d2 с допуском по h6 / d2 tolerancja h6 / d2 tolerancia h6

P703

- Technická fréza - válcová s čelním břitem
- Борфрезы - цилиндрические с торцевой заточкой
- Piłnik obrotowy - cylindryczny z uzębieniem czołowym
- Technická fréza - valcová s čelním břitom

Nad průměr 6,00 mm pájené.
Паяный хвостовик для фрез более 6 мм
Lutowany powyżej 6,00 mm
Nad priemer 6,00 mm spájkované.

P833

P703	▪	1.1	1.2	1.3	1.4	1.5	1.6	
P833	▪	7.1	7.2	7.3	7.4	8.1	8.2	8.3
	•	2.1	4.1	5.1	6.2			

P703	HM	B					ST		
P833	HM	B					AL		

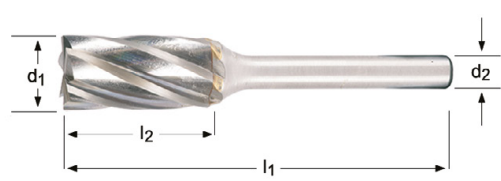

d_1 Ø mm	d_2 Ø _{h7} mm	l_2 mm	l_1 mm	P703	P833
6.00	6	18	50	P7036.0X6.0 ¹⁾	P8336.0X6.0 ¹⁾
8.00	6	19	64	P7038.0X6.0	
9.60	6	19	64	P7039.6X6.0	P8339.6X6.0
12.70	6	25	70	P70312.7X6.0	P83312.7X6.0

P805

- Technická fréza - válcová s kulovým čelem
- Борфрезы - цилиндрические со сферическим концом
- Pilnik obrotowy - cylindryczny z czolem kulistym
- Technická fréza - valcová s guľovým čelom

Nad průměr 6,00 mm pájené.
 Паяный хвостовик для фрез более 6 мм
 Lutowany powyżej 6,00 mm
 Nad priemer 6,00 mm spájkované.

P805C

P805; P805C	▪	1.1	1.2	1.3	1.4	1.5	1.6	1.7	1.8	2.1	2.2	2.3	2.4	3.1	3.2	3.3	3.4	4.1	4.2
		4.3	5.1	5.2	5.3	6.2	6.3	6.4	9.1										
	•	6.1																	

P805	HM	C				DC			
P805C	HM	C			TiAlN	DC			



d ₁ Ø mm	d ₂ Øh ₇ mm	l ₂ mm	l ₁ mm	P805	P805C
3.00	3	14	38	P8053.0X3.0 ¹⁾	P805C3.0X3.0 ¹⁾
6.30	3	12.7	45	P8056.3X3.0	
6.00	6	18	50	P8056.0X6.0 ¹⁾	P805C6.0X6.0 ¹⁾
8.00	6	19	64	P8058.0X6.0	P805C8.0X6.0
9.60	6	19	64	P8059.6X6.0	P805C9.6X6.0
12.70	6	25	70	P80512.7X6.0	P805C12.7X6.0
16.00	6	25	70	P80516.0X6.0	

¹⁾ d2 tolerance h6 / d2 с допуском по h6 / d2 tolerancja h6 / d2 tolerancia h6

P705

- Technická fréza - válcová s kulovým čelem
 - Борфрезы - цилиндрические со сферическим концом
 - Piłnik obrotowy - cylindryczny z czółem kulistym
 - Technická fréza - valcová s guľovým čelom
- Nad průměr 6,00 mm pájené.
 Паяный хвостовик для фрез более 6 мм
 Lutowany powyżej 6,00 mm
 Nad priemer 6,00 mm spájkované.

P705	▪	1.1	1.2	1.3	1.4	1.5	1.6	
P605	▪	2.1	2.2	2.3	2.4			
P835	▪	7.1	7.2	7.3	7.4	8.1	8.2	8.3
	•	2.1	4.1	5.1	6.2			

P705	HM	C				ST		
P605	HM	C				VA		
P835	HM	C				AL		

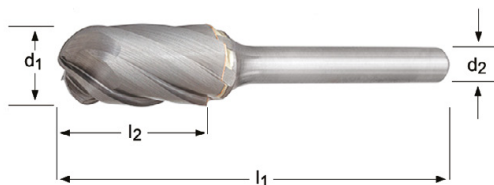

	P705	P605	P835
			
	6.00 - 12.70	3.00 - 12.70	6.00 - 12.70
	P705	P605	P835
		P6053.0X3.0 ¹⁾	
		P6056.3X3.0	
	P7056.0X6.0 ¹⁾	P6056.0X6.0 ¹⁾	P8356.0X6.0 ¹⁾
	P7058.0X6.0	P6058.0X6.0	
	P7059.6X6.0	P6059.6X6.0	P8359.6X6.0
	P70512.7X6.0	P60512.7X6.0	P83512.7X6.0

d_1 Ø mm	d_2 Ø _{h7} mm	l_2 mm	l_1 mm
3.00	3	14	38
6.30	3	12.7	45
6.00	6	18	50
8.00	6	19	64
9.60	6	19	64
12.70	6	25	70

P807

- Technická fréza - kulová
- Борфрезы - сферические

Nad průměr 6,00 mm pájené.

P807C

- Pilnik obrotowy - cylindryczny kulisty
- Technická fréza - guľová

Паяный хвостовик для фрез более 6 мм

Lutowany powyżej 6,00 mm

Nad priemer 6,00 mm spájkované.

P807; P807C	▪	1.1	1.2	1.3	1.4	1.5	1.6	1.7	1.8	2.1	2.2	2.3	2.4	3.1	3.2	3.3	3.4	4.1	4.2
		4.3	5.1	5.2	5.3	6.2	6.3	6.4	9.1										
	•	6.1																	

P807	HM	D				DC		
P807C	HM	D			TiAlN	DC		

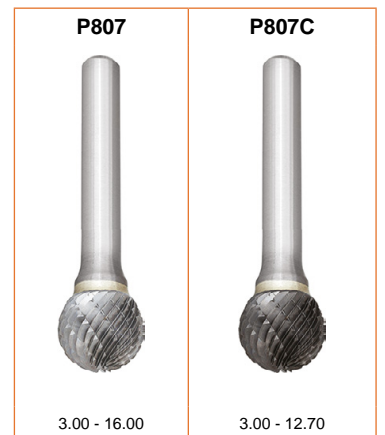
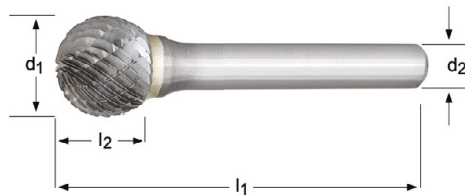

d_1 Ø mm	d_2 Øh ₇ mm	l_2 mm	l_1 mm	P807	P807C
3.00	3	2.5	38	P8073.0X3.0 ¹⁾	P807C3.0X3.0 ¹⁾
4.00	3	3.4	38	P8074.0X3.0 ¹⁾	
6.30	3	5	38	P8076.3X3.0	
6.00	6	4.7	50	P8076.0X6.0 ¹⁾	P807C6.0X6.0 ¹⁾
8.00	6	6	52	P8078.0X6.0	P807C8.0X6.0
9.60	6	8	54	P8079.6X6.0	P807C9.6X6.0
12.70	6	11	56	P80712.7X6.0	P807C12.7X6.0
16.00	6	14	59	P80716.0X6.0	

¹⁾ d2 tolerance h6 / d2 с допуском по h6 / d2 tolerancja h6 / d2 tolerancia h6

- P707** • Technická fréza - kulová
P607 • Борфрезы - сферические
P837 • Piłnik obrotowy - cylindryczny kulisty
 • Technická fréza - guľová

Nad průměr 6,00 mm pájené.
 Паяный хвостовик для фрез более 6 мм
 Lutowany powyżej 6,00 mm
 Nad priemer 6,00 mm spájkované.

P707	▪	1.1	1.2	1.3	1.4	1.5	1.6	
P607	▪	2.1	2.2	2.3	2.4			
P837	▪	7.1	7.2	7.3	7.4	8.1	8.2	8.3
	•	2.1	4.1	5.1	6.2			

P707	HM	D					ST		
P607	HM	D					VA		
P837	HM	D					AL		

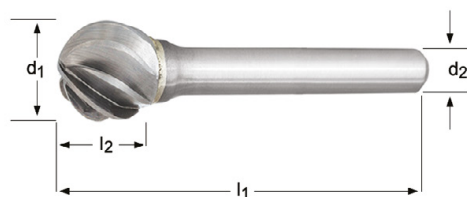

	P707	P607	P837
			
	6.00 - 12.70	3.00 - 12.70	6.00 - 12.70
	P707	P607	P837
		P6073.0X3.0 ¹⁾	
		P6076.3X3.0	
	P7076.0X6.0 ¹⁾	P6076.0X6.0 ¹⁾	P8376.0X6.0 ¹⁾
	P7078.0X6.0	P6078.0X6.0	
	P7079.6X6.0	P6079.6X6.0	P8379.6X6.0
	P70712.7X6.0	P60712.7X6.0	P83712.7X6.0

d ₁ Ø mm	d ₂ Øh ₇ mm	l ₂ mm	l ₁ mm	P707	P607	P837
3.00	3	2.5	38		P6073.0X3.0 ¹⁾	
6.30	3	5	38		P6076.3X3.0	
6.00	6	4.7	50	P7076.0X6.0 ¹⁾	P6076.0X6.0 ¹⁾	P8376.0X6.0 ¹⁾
8.00	6	6	52	P7078.0X6.0	P6078.0X6.0	
9.60	6	8	54	P7079.6X6.0	P6079.6X6.0	P8379.6X6.0
12.70	6	11	56	P70712.7X6.0	P60712.7X6.0	P83712.7X6.0

P809

- Technická fréza - oválná
- Борфрезы - эллиптические
- Piłnik obrotowy - owalny
- Technická fréza - oválna

Nad průměr 6,00 mm pájené.
 Паяный хвостовик для фрез более 6 мм
 Lutowany powyżej 6,00 mm
 Nad priemer 6,00 mm spájkované.

P809	▪	1.1	1.2	1.3	1.4	1.5	1.6	1.7	1.8	2.1	2.2	2.3	2.4	3.1	3.2	3.3	3.4	4.1	4.2	4.3	5.1
		5.2	5.3	6.2	6.3	6.4	9.1														
	•	6.1																			

P809

HM

E



DC

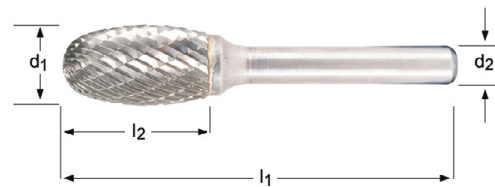

P809



3.00 - 16.00

d_1 Ø mm	d_2 Ø _{h7} mm	l_2 mm	l_1 mm	P809
3.00	3	6	38	P8093.0X3.0 ¹⁾
6.30	3	9.5	42	P8096.3X3.0
6.00	6	10	50	P8096.0X6.0 ¹⁾
8.00	6	15	60	P8098.0X6.0
9.60	6	16	60	P8099.6X6.0
12.70	6	22	67	P80912.7X6.0
16.00	6	25	70	P80916.0X6.0

¹⁾ d2 tolerance h6 / d2 с допуском по h6 / d2 tolerancja h6 / d2 tolerancia h6

P709

- Technická fréza - oválná
- Борфрезы - эллиптические

rájené
Паяный хвостовик

P609

- Piłnik obrotowy - owalny
- Technická fréza - oválná

Lutowany
Spájkované

P709 ▫ 1.1 1.2 1.3 1.4 1.5 1.6

P609 ▫ 2.1 2.2 2.3 2.4

P709

HM

E



ST



P609

HM

E



VA

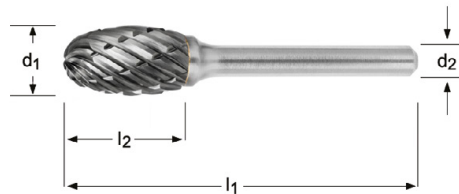

P709



12.70

P609



8.00 - 12.70

d_1 Ø mm	d_2 Ø _{h7} mm	l_2 mm	l_1 mm	P709	P609
8.00	6	15	60		P6098.0X6.0
9.60	6	16	60		P6099.6X6.0
12.70	6	22	67	P70912.7X6.0	P60912.7X6.0

P811

- Technická fréza - stromečková s kulovým čelem Nad průměr 6,00 mm pájené.
- Борфрезы - параболические Паяный хвостовик для фрез более 6 мм

P811C

- Pilnik obrotowy - łukowy z czolem kulistym Lutowany powyżej 6,00 mm
- Technická fréza - stromčeková s guľovým čelom Nad priemer 6,00 mm spájkované.

P811; P811C	▪	1.1	1.2	1.3	1.4	1.5	1.6	1.7	1.8	2.1	2.2	2.3	2.4	3.1	3.2	3.3	3.4	4.1	4.2
		4.3	5.1	5.2	5.3	6.2	6.3	6.4	9.1										
	•	6.1																	

P811	HM	F					DC			P890 526
P811C	HM	F				TiAlN	DC			P880 525



d_1 \varnothing mm	d_2 $\varnothing h_7$ mm	l_2 mm	l_1 mm	P811	P811C
3.00	3	14	38	P8113.0X3.0 ¹⁾	P811C3.0X3.0 ¹⁾
6.30	3	12.7	45	P8116.3X3.0	
6.00	6	18	50	P8116.0X6.0 ¹⁾	P811C6.0X6.0 ¹⁾
8.00	6	20	65	P8118.0X6.0	
9.60	6	19	64	P8119.6X6.0	P811C9.6X6.0
12.70	6	25	70	P81112.7X6.0	P811C12.7X6.0
16.00	6	25	70	P81116.0X6.0	

¹⁾ d2 tolerance h6 / d2 с допуском по h6 / d2 tolerancia h6 / d2 tolerancia h6

- P711** • Technická fréza - stromečková s kulovým čelem Nad průměr 6,00 mm pájené.
 • Борфрезы - параболические Паяный хвостовик для фрез более 6 мм
- P611** • Piłnik obrotowy - łukowy z czołem kulistym Lutowany powyżej 6,00 mm
- P841** • Technická fréza - stromčeková s guľovým čelom Nad priemer 6,00 mm spájkované.

P711	▪	1.1	1.2	1.3	1.4	1.5	1.6	
P611	▪	2.1	2.2	2.3	2.4			
P841	▪	7.1	7.2	7.3	7.4	8.1	8.2	8.3
	•	2.1	4.1	5.1	6.2			

P711	HM	F					ST		
P611	HM	F					VA		
P841	HM	F					AL		

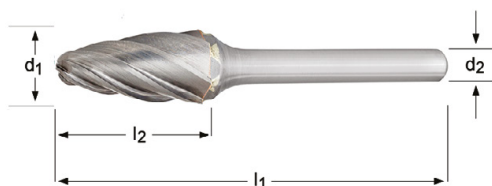

	P711	P611	P841
	6.00 - 12.70	3.00 - 12.70	6.00 - 12.70
d_1 Ø mm	P711	P611	P841
3.00		P6113.0X3.0 ¹⁾	
6.30		P6116.3X3.0	
6.00	P7116.0X6.0 ¹⁾	P6116.0X6.0 ¹⁾	P8416.0X6.0 ¹⁾
8.00	P7118.0X6.0	P6118.0X6.0	
9.60	P7119.6X6.0	P6119.6X6.0	P8419.6X6.0
12.70	P71112.7X6.0	P61112.7X6.0	P84112.7X6.0

d_1 Ø mm	d_2 Ø _{h₇} mm	l_2 mm	l_1 mm
3.00	3	14	38
6.30	3	12.7	45
6.00	6	18	50
8.00	6	20	65
9.60	6	19	64
12.70	6	25	70

¹⁾ d2 tolerance h6 / d2 с допуском по h6 / d2 tolerancia h6 / d2 tolerancia h6

P813

- Technická fréza - stromečková se špičkou
- Борфрезы - параболические заостренные
- Pilnik obrotowy - łukowy ostry
- Technická fréza - stromčeková so špičkou

Nad průměr 6,00 mm pájené.
 Паяный хвостовик для фрез более 6 мм
 Lutowany powyżej 6,00 mm
 Nad priemer 6,00 mm spájkované.

P813C

P813; P813C

▪	1.1	1.2	1.3	1.4	1.5	1.6	1.7	1.8	2.1	2.2	2.3	2.4	3.1	3.2	3.3	3.4	4.1	4.2
	4.3	5.1	5.2	5.3	6.2	6.3	6.4	9.1										
•	6.1																	

P813

HM

G



DC



P813C

HM

G



DC



P813



3.00 - 16.00

P813C



3.00 - 12.70

d_1 Ø mm	d_2 Ø _{h7} mm	l_2 mm	l_1 mm	P813	P813C
3.00	3	14	38	P8133.0X3.0 ¹⁾	P813C3.0X3.0 ¹⁾
6.30	3	12.7	45	P8136.3X3.0	
6.00	6	18	50	P8136.0X6.0 ¹⁾	P813C6.0X6.0 ¹⁾
8.00	6	19	64	P8138.0X6.0	
9.60	6	19	64	P8139.6X6.0	P813C9.6X6.0
12.70	6	25	70	P81312.7X6.0	P813C12.7X6.0
16.00	6	25	70	P81316.0X6.0	

¹⁾ d2 tolerance h6 / d2 с допуском по h6 / d2 tolerancja h6 / d2 tolerancia h6

- P713** • Technická fréza - stromečková se špičkou Nad průměr 6,00 mm pájené.
 • Борфрезы - параболические заостренные Паяный хвостовик для фрез более 6 мм
- P613** • Pilnik obrotowy - łukowy ostry Lutowany powyżej 6,00 mm
 • Technická fréza - stromčeková so špičkou Nad priemer 6,00 mm spájkované.

P713 ▀ 1.1 1.2 1.3 1.4 1.5 1.6

P613 ▀ 2.1 2.2 2.3 2.4

P713 HM G       ST 

P613 HM G      VA 

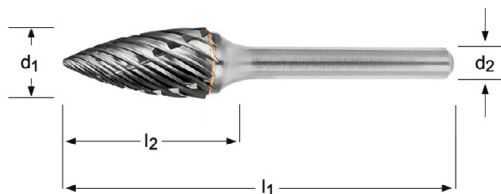

d_1 Ø mm	d_2 Øh ₇ mm	l_2 mm	l_1 mm	P713	P613
6.00	6	18	50	P7136.0X6.0 ¹⁾	P6136.0X6.0 ¹⁾
8.00	6	19	64	P7138.0X6.0	P6138.0X6.0
9.60	6	19	64	P7139.6X6.0	P6139.6X6.0
12.70	6	25	70	P71312.7X6.0	P61312.7X6.0

¹⁾ d2 tolerance h6 / d2 с допуском по h6 / d2 tolerancia h6 / d2 tolerancia h6

P815

- Technická fréza - plamínková
- Борфрезы - факелоподобные
- Piłnik obrotowy - płomykowy
- Technická fréza - plamienková

Nad průměr 6,00 mm pájené.
Паяный хвостовик для фрез более 6 мм
Lutowany powyżej 6,00 mm
Nad priemer 6,00 mm spájkované.

P815C

- Technická fréza - plamínková
- Борфрезы - факелоподобные
- Piłnik obrotowy - płomykowy
- Technická fréza - plamienková

rájené
Паяный хвостовик
Lutowany
Spájkované

P815; P815C	▪	1.1	1.2	1.3	1.4	1.5	1.6	1.7	1.8	2.1	2.2	2.3	2.4	3.1	3.2	3.3	3.4	4.1	4.2
		4.3	5.1	5.2	5.3	6.2	6.3	6.4	9.1										
	•	6.1																	

P815

HM

H



DC



P815C

HM

H



TiAlN

DC

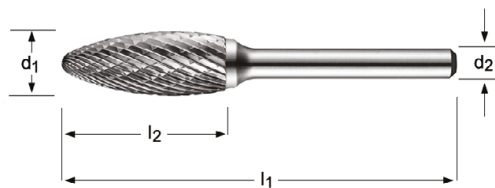

P815



3.00 - 16.00

P815C



8.00 - 12.70

d_1 Ø mm	d_2 Ø _{h7} mm	l_2 mm	l_1 mm	P815	P815C
3.00	3	6	38	P8153.0X3.0 ¹⁾	
6.00	6	14	50	P8156.0X6.0 ¹⁾	
8.00	6	19	64	P8158.0X6.0	P815C8.0X6.0
9.60	6	19	65	P8159.6X6.0	
12.70	6	32	77	P81512.7X6.0	P815C12.7X6.0
16.00	6	36	81	P81516.0X6.0	

¹⁾ d2 tolerance h6 / d2 с допуском по h6 / d2 tolerancja h6 / d2 tolerancia h6

- P715** • Technická fréza - plamínková pájené
 • Борфрезы - Факелоподобные факелоподобные
- P615** • Piłnik obrotowy - płomykowy Lutowany
 • Technická fréza - plamienková Spájkované

P715 ■ 1.1 1.2 1.3 1.4 1.5 1.6

P615 ■ 2.1 2.2 2.3 2.4

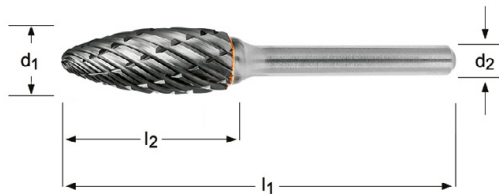

d_1 Ø mm	d_2 Ø _{h₇} mm	l_2 mm	l_1 mm	P715	P615
8.00	6	19	64	P7158.0X6.0	P6158.0X6.0
9.60	6	19	65		P6159.6X6.0
12.70	6	32	77	P71512.7X6.0	P61512.7X6.0

P817

- Technická fréza - 60° srážeč
- Борфрезы - конические с углом 60°
- Pilnik obrotowy - stożkowy 60°
- Technická fréza - 60° zřázač

Nad průměr 6,00 mm pájené.
 Паяный хвостовик для фрез более 6 мм
 Lutowany powyżej 6,00 mm
 Nad priemer 6,00 mm spájkované.

P817	▪	1.1	1.2	1.3	1.4	1.5	1.6	1.7	1.8	2.1	2.2	2.3	2.4	3.1	3.2	3.3	3.4	4.1	4.2	4.3	5.1
		5.2	5.3	6.2	6.3	6.4	9.1														
	•	6.1																			

P817

HM

J



DC

DORMER



d_1 ∅ mm	d_2 ∅ h_7 mm	l_2 mm	l_1 mm	P817
3.00	3	2.5	38	P8173.0X3.0 ¹⁾
6.00	6	4	50	P8176.0X6.0 ¹⁾
9.60	6	8	56	P8179.6X6.0
12.70	6	11	59	P81712.7X6.0
16.00	6	14.5	63	P81716.0X6.0

¹⁾ d2 tolerance h6 / d2 с допуском по h6 / d2 tolerancja h6 / d2 tolerancia h6

P819

- Technická fréza - 90° srážeč
- Борфрезы - конические с углом 90°
- Pilnik obrotowy - stożkowy 90°
- Technická fréza - 90° zrážač

Nad průměr 6,00 mm pájené.
 Паяный хвостовик для фрез более 6 мм
 Lutowany powyżej 6,00 mm
 Nad priemer 6,00 mm spájkované.

P819	▪	1.1	1.2	1.3	1.4	1.5	1.6	1.7	1.8	2.1	2.2	2.3	2.4	3.1	3.2	3.3	3.4	4.1	4.2	4.3	5.1	
		5.2	5.3	6.2	6.3	6.4	9.1															
	•	6.1																				

P819

HM

K



DC

DORMER



P819



3.00 - 16.00

d_1 Ø mm	d_2 Øh ₇ mm	l_2 mm	l_1 mm	P819
3.00	3	1.5	38	P8193.0X3.0 ¹⁾
6.00	6	3	50	P8196.0X6.0 ¹⁾
9.60	6	4.7	53	P8199.6X6.0
12.70	6	6.3	55	P81912.7X6.0
16.00	6	8	57	P81916.0X6.0

¹⁾ d2 tolerance h6 / d2 с допуском по h6 / d2 tolerancia h6 / d2 tolerancia h6

P821

- Technická fréza - kuželová s kulovým čelem
- Борфрезы - конические со сферическим концом
- Pilnik obrotowy - łukowy zaokrąglony
- Technická fréza - kuželová s guľovým čelom

Nad průměr 6,00 mm pájené.
 Паяный хвостовик для фрез более 6 мм
 Lutowany powyżej 6,00 mm
 Nad priemer 6,00 mm spájkované.

P821C

P821; P821C

▪	1.1	1.2	1.3	1.4	1.5	1.6	1.7	1.8	2.1	2.2	2.3	2.4	3.1	3.2	3.3	3.4	4.1	4.2
	4.3	5.1	5.2	5.3	6.2	6.3	6.4	9.1										
•	6.1																	

P821



P821C

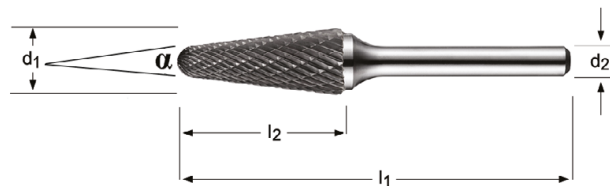

d_1 Ø mm	d_2 Ø _{h7} mm	l_2 mm	l_1 mm	α	P821	P821C
3.00	3	14	38	8°	P8213.0X3.0 ¹⁾	P821C3.0X3.0 ¹⁾
6.00	6	18	50	14°	P8216.0X6.0 ¹⁾	
8.00	6	25.4	70	14°	P8218.0X6.0	
9.60	6	30	76	14°	P8219.6X6.0	
12.70	6	32	77	14°	P82112.7X6.0	P821C12.7X6.0
16.00	6	33	78	14°	P82116.0X6.0	

¹⁾ d2 tolerance h6 / d2 с допуском по h6 / d2 tolerancja h6 / d2 tolerancia h6

P721 • Technická fréza - kuželová s kulovým čelem rájené
 • Борфрезы - конические со сферическим концом Паяный хвостовик

P621 • Piłnik obrotowy - łukowy zaokrąglony Lutowany
 • Technická fréza - kuželová s guľovým čelom Spájkované

P842 • Technická fréza - kuželová s kulovým čelom Nad průměr 6,00 mm rájené.
 • Борфрезы - конические со сферическим концом Паяный хвостовик для фрез более 6 мм
 • Piłnik obrotowy - łukowy zaokrąglony Lutowany powyżej 6,00 mm
 • Technická fréza - kuželová s guľovým čelom Nad priemer 6,00 mm spájkované.

P721	▪	1.1	1.2	1.3	1.4	1.5	1.6	
P621	▪	2.1	2.2	2.3	2.4			
P842	▪	7.1	7.2	7.3	7.4	8.1	8.2	8.3
	•	2.1	4.1	5.1	6.2			

P721	HM	L					ST		
P621	HM	L					VA		
P842	HM	L					AL		



d ₁ ∅ mm	d ₂ ∅h ₇ mm	l ₂ mm	l ₁ mm	α	P721	P621	P842
6.00	6	18	50	14°			P8426.0X6.0 ¹⁾
8.00	6	25.4	70	14°		P6218.0X6.0	
10.00	6	20	65	14°	P72110.0X6.0	P62110.0X6.0	
9.60	6	30	76	14°	P7219.6X6.0		P8429.6X6.0
12.70	6	32	77	14°	P72112.7X6.0	P62112.7X6.0	P84212.7X6.0

¹⁾ d2 tolerance h6 / d2 с допуском по h6 / d2 tolerancja h6 / d2 tolerancia h6
 520

P823

- Technická fréza - kuželová
- Борфрезы - конические
- Pilnik obrotowy - stożkowy
- Technická fréza - kuželová

Nad průměr 6,00 mm pájené.
 Паяный хвостовик для фрез более 6 мм
 Lutowany powyżej 6,00 mm
 Nad priemer 6,00 mm spájkované.

P823	▪	1.1	1.2	1.3	1.4	1.5	1.6	1.7	1.8	2.1	2.2	2.3	2.4	3.1	3.2	3.3	3.4	4.1	4.2	4.3	5.1	
		5.2	5.3	6.2	6.3	6.4	9.1															
	•	6.1																				

P823

HM

M



DC

DORMER



P823



3.00 - 16.00

d_1 Ø mm	d_2 Ø _{h7} mm	l_2 mm	l_1 mm		P823
3.00	3	11	38	14°	P8233.0X3.0 ¹⁾
6.30	3	12.7	49	22°	P8236.3X3.0
6.00	6	20	50	14°	P8236.0X6.0 ¹⁾
9.60	6	16	64	28°	P8239.6X6.0
12.70	6	22	71	28°	P82312.7X6.0
16.00	6	25	71	31°	P82316.0X6.0

¹⁾ d2 tolerance h6 / d2 с допуском по h6 / d2 tolerancja h6 / d2 tolerancia h6

P825

- Technická fréza - kuželová inverzní
- Борфрезы - конические обратные
- Piłnik obrotowy - stożkowy odwrotny
- Technická fréza - kuželová inverzná

Nad průměr 6,00 mm pájené.
 Паяный хвостовик для фрез более 6 мм
 Lutowany powyżej 6,00 mm
 Nad priemer 6,00 mm spájkované.

P825	▪	1.1	1.2	1.3	1.4	1.5	1.6	1.7	1.8	2.1	2.2	2.3	2.4	3.1	3.2	3.3	3.4	4.1	4.2	4.3	5.1	
		5.2	5.3	6.2	6.3	6.4	9.1															
	•	6.1																				

P825

HM

N



DC

DORMER

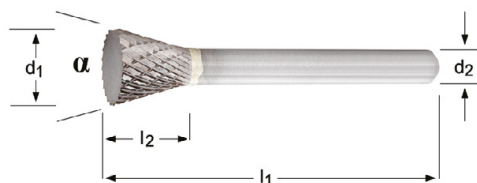

P825



3.00 - 16.00

d_1 Ø mm	d_2 Ø _{h7} mm	l_2 mm	l_1 mm		P825
3.00	3	4	38	10°	P8253.0X3.0 ¹⁾
6.30	3	6	39	12°	P8256.3X3.0
6.00	6	8	50	10°	P8256.0X6.0 ¹⁾
9.60	6	9.5	55	16°	P8259.6X6.0
12.70	6	12.7	58	28°	P82512.7X6.0
16.00	6	19	64	18°	P82516.0X6.0

¹⁾ d2 tolerance h6 / d2 с допуском по h6 / d2 tolerancja h6 / d2 tolerancia h6

- P843**
- Diamantová vrtací fréza – úhel špičky 135°
 - Борфрезы с ромбической насечкой и углом при вершине 135°
 - Frez diamentowy z wierzchołkiem 135°
 - Diamantová fréza – 135° hrot vrtáka

P843 ■ 8.1 8.2 8.3

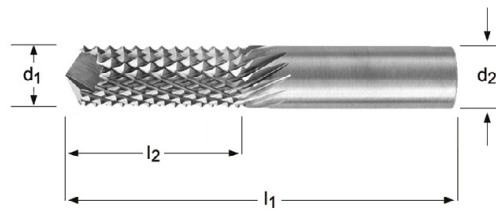

d_1 Ø mm	d_2 Ø _{h₆} mm	l_2 mm	l_1 mm	P843
3.00	3	13	45	P8433.0X3.0
6.00	6	19	63	P8436.0X6.0
8.00	8	25	63	P8438.0X8.0

- P844**
- Diamantová fréza – válcová
 - Борфрезы с ромбической насечкой и углом при вершине 180°
 - Frez diamentowy do frezowania walcowo-czołowego
 - Diamantová fréza – valcová fréza

P844 ■ 8.1 8.2 8.3

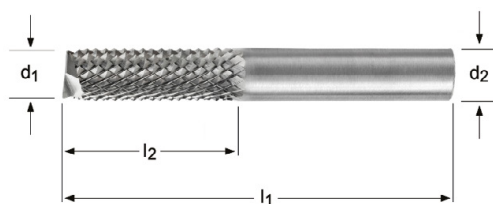

d_1 Ø mm	d_2 Ø _{h6} mm	l_2 mm	l_1 mm	P844
3.00	3	13	45	P8443.0X3.0
6.00	6	19	63	P8446.0X6.0
8.00	8	25	63	P8448.0X8.0

P880

- Sada technických fréz
- Наборы борфрез
- Piłniki obrotowe - zestaw
- Sada technických fréz

A=typy v sadě, B=počet v sadě, C=rozměry v sadě

A=типы борфрез в наборе, B=кол-во борфрез, C=борфрезы

A=Typy w komplecie. B=Ilość w komplecie. C=Średnice występujące w komplecie

A=typy v sade, B=počet v sade, C=rozmery v sade



Nr.	A	B	C	P880
Nr01	P803 + P805 + P807 + P809 + P813	5	P8039.6X6.0, P8059.6X6.0, P8079.6X6.0, P8099.6X6.0, P8139.6X6.0	P88001
Nr02	P803C + P805C + P807C + P811C + P813C	5	P803C9.6X6.0, P805C9.6X6.0, P807C9.6X6.0, P811C9.6X6.0, P813C9.6X6.0	P88002
Nr03	P601 + P605 + P607 + P611 + P621	5	P6019.6X6.0, P6059.6X6.0, P6079.6X6.0, P6119.6X6.0, P62110.0X6.0	P88003
Nr04	P703 + P705 + P707 + P711 + P721	5	P7039.6X6.0, P7059.6X6.0, P7079.6X6.0, P7119.6X6.0, P72110.0X6.0	P88004

P890

- Technické frézy - dispenser
- Наборы борфрез
- Piłniki obrotowe - zestaw
- Technické frézy - dispenser

A=typy v sadě, B=počet v sadě, C=rozměry v sadě

A=типы борфрез в наборе, B=кол-во борфрез, C=борфрезы

A=Typy w komplecie. B=Ilość w komplecie. C=Średnice występujące w komplecie

A=typy v sade, B=počet v sade, C=rozmery v sade



Nr.	A	B	C	P890
Nr01	P803 + P805 + P811 + P813 + P821	40	P803(6.0X6.0, 8.0X6.0, 9.6X6.0, 12.7X6.0) X 2, P805(6.0X6.0, 8.0X6.0, 9.6X6.0, 12.7X6.0) X 2, P811(6.0X6.0, 8.0X6.0, 9.6X6.0, 12.7X6.0) X 2, P813(6.0X6.0, 8.0X6.0, 9.6X6.0, 12.7X6.0) X 2, P821(6.0X6.0, 8.0X6.0, 9.6X6.0, 12.7X6.0) X 2	P89001

K100	536	K305	533
K101	536	K310	534
K102	536	K311	534
K103	537	K312	534
K104	537	K313	534
K200	538	K314	534
K201	538	K330	535
K202	538	K520	539
K203	538	K521	540
K204	538	K522	541
K300	533	M150	542
K301	533	M151	543
K302	533	M152	544
K303	533	M200	545
K304	533		

527 - 546

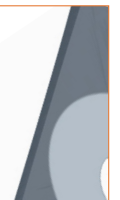
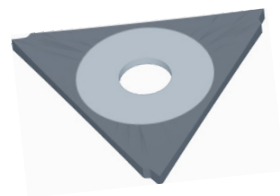

Materiál	Материал	Materiał	Materiál
Povlak	Покрытие	Pokrycie	Povlak
Standard	Стандарт	Standard	Štandard
Úhel břitu ostřĩ	Угол в плане при отрезке	Kąt ostrza	Uhol britu/ oštria
Použitĩ	Применение	Zastosowanie	Použitie
Směr otáčení	направление вращения	Kierunek	Prevedenie pravéřlavé
Velikost destičky	Размер пластины	Wymiar Płytki	Veľkosť došřičky
<ul style="list-style-type: none"> ■ vynikající ● dobrý <p>Přĩklad 10 = řezná rychlost (m/min) +/- 10%</p>	<p>Основное применение</p> <p>Возможное применение</p> <p>Пример: 10 = Скорость резания в м/мин +/- 10%</p>	<p>Najlepsze zastosowanie</p> <p>Dobre zastosowanie</p> <p>Na Przykład 10 = prędkość skrawania w m/min +/- 10%</p>	<p>Vynikajúce</p> <p>Dobré</p> <p>Přĩklad 10 = rezná rýchlosť (m/min) +/- 10%</p>
Kód	Код	Kod	Kód
Rozměrová řada	Ассортимент	Zakres	Rozsah rozmerov

AMG	Česky	Русский	Polski	Slovensky
1.1	magneticky měkká	Автоматная сталь	magnetyczna miękka	Magnetycky mäkká oceľ
1.2	konstrukční uhlíkatá	Низкоуглеродистая сталь	konstrukcyjna do nawęglania	Konstruktöna ocele, uhlíková
1.3	uhlíkatá	Углеродистая нелегированная сталь	węglowa	Uhlíková oceľ
1.4	legovaná	Легированная сталь	stopowa	Legovaná oceľ
1.5	legovaná, tvrzená a temperovaná	Легированная сталь после отжига	stopowa-hartowana i odpuszczana	Legovaná oceľ, tvrdená a temperovaná
1.6	legovaná, tvrzená a temperovaná	Высоколегированная сталь после отжига	stopowa-hartowana i odpuszczana	Legovaná oceľ, tvrdená a temperovaná
1.7	legovaná, tvrzená	Легированная закаленная сталь	stopowa-hartowana	Legovaná oceľ tvrdená
1.8	legovaná, tvrzená	Легированная закаленная сталь	stopowa-hartowana	Legovaná oceľ tvrdená, oceľ odolná oproti opotrebovaniu
2.1	automatová	Ферритная нержавеющая сталь	automatowa	Automatová nehrdzavejúca oceľ
2.2	austenitická	Аустенитная нержавеющая сталь	austenityczna	Austenická
2.3	feritická+austenitická	Ферритно-аустенитная нержавеющая сталь	ferytyczna+austenityczna	Feriticko austenitická nehr. oceľ (Duplex)
2.4	precipitačně tvrzená	Сталь дисперсионного твердения	Utwardzane wydzieleniowo	Tvrdená nehr. oceľ
3.1	lamelární	Серый чугуn	szare	Sivá liatina
3.2	lamelární	Ковкий чугуn	szare	Sivá liatina
3.3	nodulární	Высокопрочный чугуn	sferoidalne cięgliwe	Tvárna liatina
3.4	nodulární	Высокопрочный чугуn	sferoidalne cięgliwe	Tvárna liatina
4.1	čistý	Технически чистый титан	niestopowy	Čistý titán
4.2	slitiny	Титановые сплавы	stopy tytanu	Zliatiny titánu
4.3	slitiny	Титановые сплавы	stopy tytanu	Zliatiny titánu
5.1	čistý	Технически чистый никель	niestopowy	Čistý nikel
5.2	slitiny	Никелевые сплавы	stopy niklu	Zliatiny niklu
5.3	slitiny	Никелевые сплавы	stopy niklu	Zliatiny niklu
6.1	bronz	Технически чистая медь	niestopowa	Bronz
6.2	ř - mosaz, bronz	Бронза	Mosiądz-ř, brąz	ř - mosadz, bronz
6.3	bronz mosaz	Латунь	Mosiądz CuZn	Mosadz, bronz
6.4	bronz vysokopevnostní	Высокопрочная бронза	Brąz o wysokiej wytrzymałości	Vysokopevnostný bronz
7.1	Al, Mg, tvářené	Технически чистый алюминий/магний	Al.,Mg, niestopowe	Al, Mg, tvárnený (čistý)
7.2	Al slitiny, Si<0.5%	Сплавы Al с содержанием Si<0.5%	Al. Stopowe, Si<0,5%	Al zliatiny, Si<0,5%
7.3	Al slitiny, Si>0.5%<10%	Сплавы Al с содержанием 0.5%<Si<10%	Al. Stopowe, Si>0,5%<10%	Al zliatiny, Si>0,5%<10%
7.4	Al slitiny, Si>10%	Сплавы Al с содержанием Si>10%	Al. Stopowe, Si>10%	Al zliatiny, Si>10%
8.1	termoplasty	Термопластики	Tworzywa termoplastyczne	Termoplasty
8.2	termosety	Терморезактивные полимеры	Tworzywa termoutwardzalne	Termosety
8.3	zpevněné plasty	Армированные полимеры	Zbrojone tworzywa sztuczne	Spevněné plasty
9.1	cermet (keramika)	Металлокерамика	Cermetale	Cermet (kov-keramika)
10.1	standardni grafit	Технический графит	Grafit standartowy	Grafit

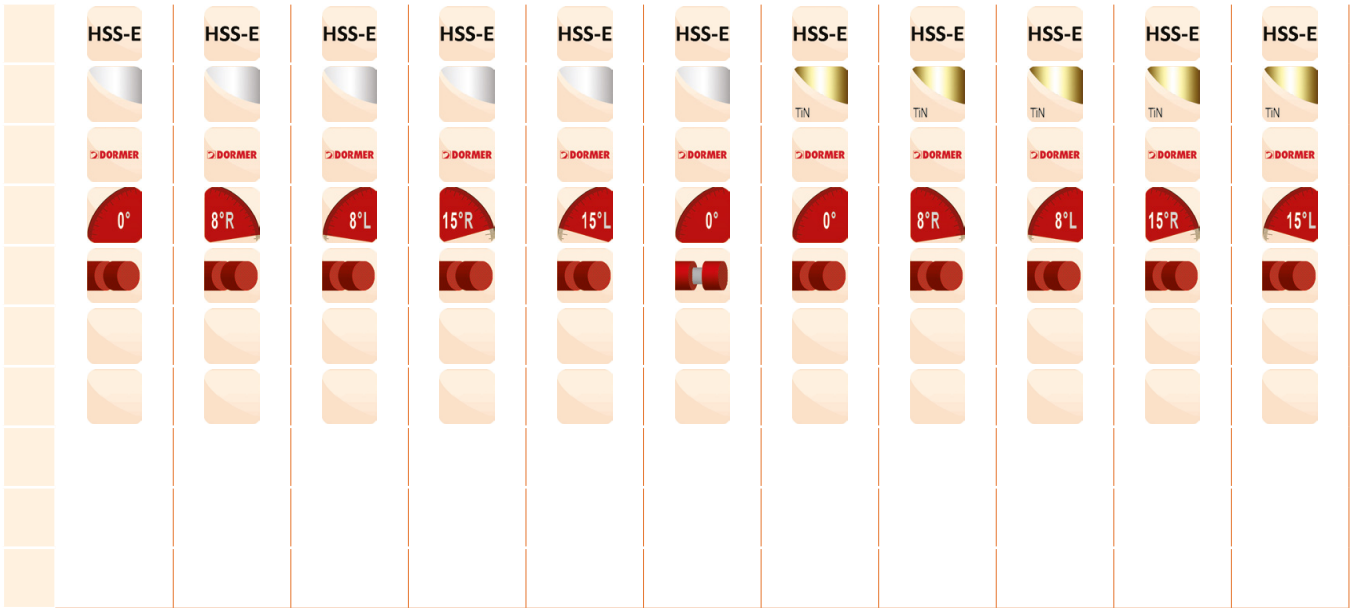

	K300	K301	K302	K303	K304	K305	K310	K311	K312	K313	K314	
	1.50 - 2.50	1.50 - 2.50	1.50 - 2.50	1.50 - 2.50	1.50 - 2.50	1.10 - 2.15	23.00 - 40.00	23.00 - 40.00	23.00 - 40.00	23.00 - 40.00	23.00 - 40.00	
AMG	533	533	533	533	533	533	534	534	534	534	534	ISO
1.1	50A	50A	50A	50A	50A	50A	120A	120A	120A	120A	120A	P 1
1.2	40B	40B	40B	40B	40B	40B	100B	100B	100B	100B	100B	P 1
1.3	30C	30C	30C	30C	30C	30C	60C	60C	60C	60C	60C	P 2
1.4	20D	20D	20D	20D	20D	20D	50D	50D	50D	50D	50D	P 3
1.5							20E	20E	20E	20E	20E	P 4
1.6												H 1
1.7												H 3
1.8												H 4
2.1	15C	15C	15C	15C	15C	15C	20C	20C	20C	20C	20C	M 1
2.2							20C	20C	20C	20C	20C	M 3
2.3							10B	10B	10B	10B	10B	M 2
2.4												S 2
3.1												K 1
3.2												K 2
3.3												K 3
3.4												K 4
4.1												S 1
4.2												S 2
4.3												S 3
5.1												S 1
5.2												S 2
5.3												S 3
6.1	100B	100B	100B	100B	100B	100B	250B	250B	250B	250B	250B	N 3
6.2	65C	65C	65C	65C	65C	65C	160C	160C	160C	160C	160C	N 4
6.3	100B	100B	100B	100B	100B	100B	250B	250B	250B	250B	250B	N 3
6.4												N 4
7.1	150A	150A	150A	150A	150A	150A	370A	370A	370A	370A	370A	N 1
7.2	150B	150B	150B	150B	150B	150B	370B	370B	370B	370B	370B	N 1
7.3							110C	110C	110C	110C	110C	N 1
7.4							45D	45D	45D	45D	45D	N 2
8.1												O
8.2												O
8.3												O
9.1												H
10.1												O

	23mm	40mm
A	0.20	0.25
B	0.15	0.20
C	0.10	0.15
D	0.05	0.10
E	0.03	0.05

	23mm	40mm
A	0.20	0.25
B	0.15	0.20
C	0.10	0.15
D	0.05	0.10
E	0.03	0.05

HSS-E



K330

23.00 - 40.00



K100

10.00 - 20.00

K101

12.00 - 20.00

K102

10.00 - 14.00

K103

16.00 - 32.00

K104

16.00 - 32.00

AMG



535

- 120A
- 100B
- 60C
- 50D
- 20E

536

536

536

537

537

ISO

1.1									P 1
1.2									P 1
1.3									P 2
1.4									P 3
1.5									P 4
1.6									H 1
1.7									H 3
1.8									H 4
2.1									M 1
2.2									M 3
2.3									M 2
2.4									S 2
3.1									K 1
3.2									K 2
3.3									K 3
3.4									K 4
4.1									S 1
4.2									S 2
4.3									S 3
5.1									S 1
5.2									S 2
5.3									S 3
6.1									N 3
6.2									N 4
6.3									N 3
6.4									N 4
7.1									N 1
7.2									N 1
7.3									N 1
7.4									N 2
8.1									O
8.2									O
8.3									O
9.1									H
10.1									O

	23mm	40mm
A	0.20	0.25
B	0.15	0.20
C	0.10	0.15
D	0.05	0.10
E	0.03	0.05

- 250B
- 160C
- 250B

- 370A
- 370B
- 110C
- 45D

						HSS-E	HSS-E	HSS-E	
	K200	K201	K202	K203	K204	K520	K521	K522	
	1.50	1.50	1.50	2.50	2.50	4.00 - 5/8"	3.00 - 20	10.00 - 25	
						DIN 4964B	DIN 4964A	DIN 4964D	
						h13	h9	h13	
AMG	538	538	538	538	538	539	540	541	ISO
1.1						■80A	■80A	■80A	P 1
1.2						■80A	■80A	■80A	P 1
1.3						■65A	■65A	■65A	P 2
1.4						■55A	■55A	■55A	P 3
1.5						●35A	●35A	●35A	P 4
1.6									H 1
1.7									H 3
1.8									H 4
2.1						●37A	●37A	●37A	M 1
2.2						●30A	●30A	●30A	M 3
2.3									M 2
2.4									S 2
3.1						■60A	■60A	■60A	K 1
3.2						■50A	■50A	■50A	K 2
3.3						■40A	■40A	■40A	K 3
3.4						■25A	■25A	■25A	K 4
4.1									S 1
4.2									S 2
4.3									S 3
5.1									S 1
5.2									S 2
5.3									S 3
6.1						■100A	■100A	■100A	N 3
6.2						■65A	■65A	■65A	N 4
6.3						■100A	■100A	■100A	N 3
6.4						●50A	●50A	●50A	N 4
7.1						●120A	●120A	●120A	N 1
7.2						●150A	●150A	●150A	N 1
7.3									N 1
7.4									N 2
8.1									O
8.2									O
8.3									O
9.1									H
10.1									O

	M150	M151	M152	M200	M200	M200	ISO
	542	543	544	545	545	545	
1.1				■			P 1
1.2				■		●	P 1
1.3				■		●	P 2
1.4				■		●	P 3
1.5				■		■	P 4
1.6				■		■	H 1
1.7				●		■	H 3
1.8				●		■	H 4
2.1				■		■	M 1
2.2				■		■	M 3
2.3				■		■	M 2
2.4				●		■	S 2
3.1				■		●	K 1
3.2				■		●	K 2
3.3				■		●	K 3
3.4				■		●	K 4
4.1				■		■	S 1
4.2				■		■	S 2
4.3				■		■	S 3
5.1				■		■	S 1
5.2				■		■	S 2
5.3				■		■	S 3
6.1					●		N 3
6.2					●		N 4
6.3					●		N 3
6.4					●		N 4
7.1					■		N 1
7.2					■		N 1
7.3					■		N 1
7.4					■		N 2
8.1							O
8.2							O
8.3							O
9.1							H
10.1							O

K300

- Destička upichovací
- Пластины для отрезки
- Płytką tnącą
- Doštička upichovacia



K301

- Destička upichovací
- Пластины для отрезки
- Płytką tnącą
- Doštička upichovacia



K302

- Destička upichovací
- Пластины для отрезки
- Płytką tnącą
- Doštička upichovacia



K303

- Destička upichovací
- Пластины для отрезки
- Płytką tnącą
- Doštička upichovacia



K304

- Destička upichovací
- Пластины для отрезки
- Płytką tnącą
- Doštička upichovacia



K305

- Destička upichovací
- Пластины для отрезки
- Płytką tnącą
- Doštička upichovacia

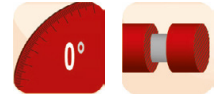

K300; K301; K302; K303; K304; K305

- 1.1 1.2 6.2 6.3
- 1.3 1.4 2.1 6.1 7.1 7.2

K300	HSS-E					
K301	HSS-E					
K302	HSS-E					
K303	HSS-E					
K304	HSS-E					
K305	HSS-E					

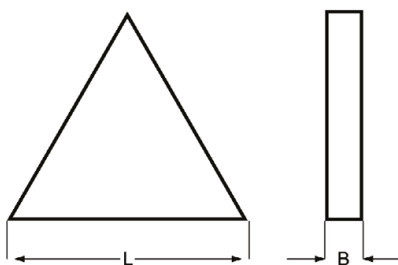

K300	K301	K302	K303	K304	K305
1.50 - 2.50	1.50 - 2.50	1.50 - 2.50	1.50 - 2.50	1.50 - 2.50	1.10 - 2.15

L	B	d min-max mm	K300	K301	K302	K303	K304	K305
23	1.10	9 - 17						K30523.0X1.1
23	1.30	18 - 26						K30523.0X1.3
23	1.50		K30023.0X1.5	K30123.0X1.5	K30223.0X1.5	K30323.0X1.5	K30423.0X1.5	
23	1.60	28 - 35						K30523.0X1.6
40	1.85	36 - 48						K30540.0X1.85
40	2.15	50 - 63						K30540.0X2.15
40	2.50		K30040.0X2.5	K30140.0X2.5	K30240.0X2.5	K30340.0X2.5	K30440.0X2.5	

K310

- Destička upichovací
- Пластины для отрезки
- Płytką tnąca
- Doštička upichovacia



K311

- Destička upichovací
- Пластины для отрезки
- Płytką tnąca
- Doštička upichovacia



K312

- Destička upichovací
- Пластины для отрезки
- Płytką tnąca
- Doštička upichovacia



K313

- Destička upichovací
- Пластины для отрезки
- Płytką tnąca
- Doštička upichovacia



K314

- Destička upichovací
- Пластины для отрезки
- Płytką tnąca
- Doštička upichovacia



K310; K311; K312; K313; K314	▪	1.1	1.2	1.3	2.1	2.2	6.1	6.2	6.3	7.1	7.2	7.3
	•	1.4	1.5	2.3	7.4							

K310	HSS-E	TIN	DORMER	0°			
K311	HSS-E	TIN	DORMER	8°R			
K312	HSS-E	TIN	DORMER	8°L			
K313	HSS-E	TIN	DORMER	15°R			
K314	HSS-E	TIN	DORMER	15°L			

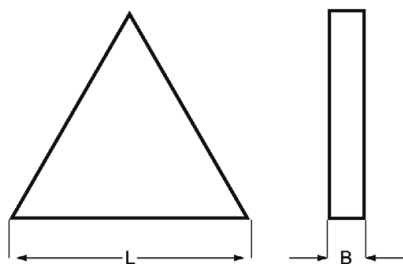

K310	K311	K312	K313	K314
23.00 - 40.00	23.00 - 40.00	23.00 - 40.00	23.00 - 40.00	23.00 - 40.00

L	B	K310	K311	K312	K313	K314
23	1.50	K31023.0X1.5	K31123.0X1.5	K31223.0X1.5	K31323.0X1.5	K31423.0X1.5
40	2.50	K31040.0X2.5	K31140.0X2.5	K31240.0X2.5	K31340.0X2.5	K31440.0X2.5

K330

- Destička upichovací
- Пластины для отрезки
- Płytkę tnąca
- Doštička upichovacia



K330	▪	1.1	1.2	1.3	2.1	2.2	6.1	6.2	6.3	7.1	7.2	7.3
	•	1.4	1.5	2.3	7.4							

K330 HSS-E TiAIN DORMER 0°

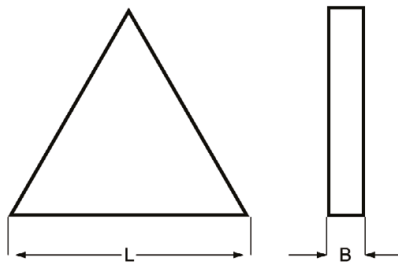

K330

23.00 - 40.00

L	B	K330
23	1.50	K33023.0X1.5

- K100** • Držák pro upichovací destičku
- K101** • Отрезные державки
- K102** • Uchwyty do płytek tnących
- Držiak na upichovaci doštičku

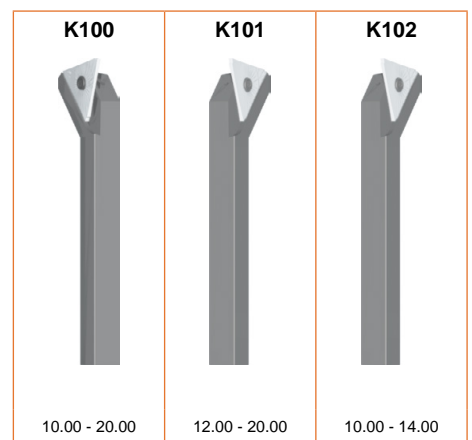
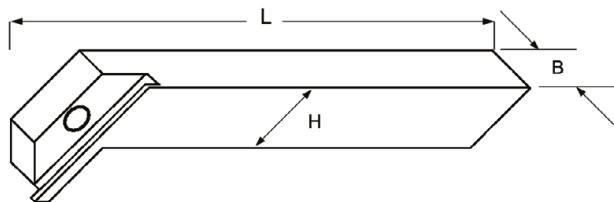

H	B	L	K100	K101	K102
10	10	125	K10010.0		K10210.0
12	12	125	K10012.0	K10112.0	
20	12	125	K10020.0	K10120.0	

- K103** • Držák pro upichovací destičku
 • Отрезные державки
- K104** • Uchwyty do płytek tnących
 • Drżiak na upichowaciu dořtičku

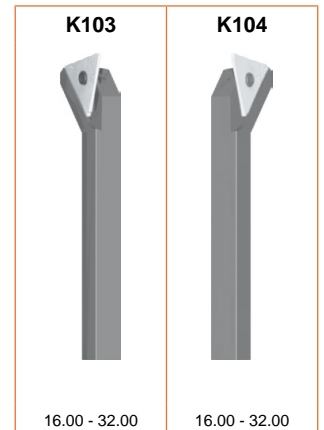
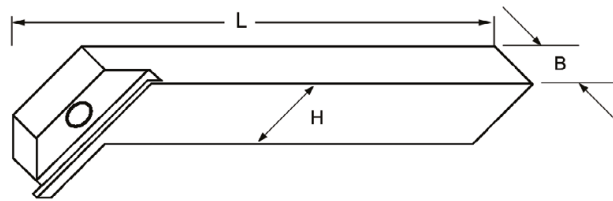

H	B	L	K103	K104
16	16	140	K10316.0	K10416.0
25	16	140	K10325.0	K10425.0

- K200** • Náhradní díly pro upichovací nástroje
- K201** • Запасные части для токарных державок
- K202** • Części zamienne dla uchwytów do płytek tnących
- K203** • Części zamienne dla uchwytów do płytek tnących
- K204** • Náhradné diely pre upichovacie nástroje



size	tool code	K200	K201	K202	K203	K204
1.5	Excentric	K200ECC1.5				
1.5	Spanner		K201SPAN1.5			
1.5-2.5	Pin			K2022.5X12.0		
2.5	Excentric				K203ECC2.5	
2.5	Spanner					K204SPAN2.5

K520

- Polotovary
- Заготовки для резцов из быстрорежущей стали квадратного сечения h13
- Póffabrykat
- Polotovary

K520	▪	1.1	1.2	1.3	1.4	3.1	3.2	3.3	3.4	6.1	6.2	6.3
	•	1.5	2.1	2.2	6.4	7.1	7.2					

K520 HSS-E

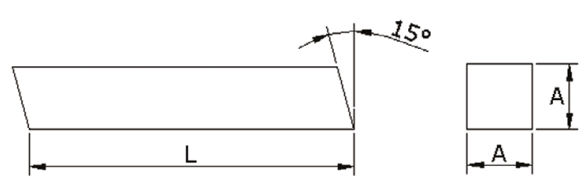

A	L	K520
4	100	K5204.0X100.0
5	160	K5205.0X160.0
6	100	K5206.0X100.0
6	160	K5206.0X160.0
6	200	K5206.0X200.0
8	100	K5208.0X100.0
8	160	K5208.0X160.0
8	200	K5208.0X200.0
10	100	K52010.0X100.0
10	160	K52010.0X160.0
10	200	K52010.0X200.0
12	100	K52012.0X100.0
12	160	K52012.0X160.0
12	200	K52012.0X200.0
14	160	K52014.0X160.0
14	200	K52014.0X200.0
16	100	K52016.0X100.0
16	160	K52016.0X160.0
16	200	K52016.0X200.0
20	160	K52020.0X160.0
20	200	K52020.0X200.0
25	200	K52025.0X200.0
3/16	2.1/2	K5203/16X2.1/2
1/4	2.1/2	K5201/4X2.1/2
1/4	4"	K5201/4X4
5/16	2.1/2	K5205/16X2.1/2
5/16	3"	K5205/16X3
5/16	4"	K5205/16X4
3/8	3"	K5203/8X3
3/8	4"	K5203/8X4
3/8	6"	K5203/8X6
7/16	3.1/2	K5207/16X3.1/2
1/2	4"	K5201/2X4
1/2	6"	K5201/2X6
5/8	4.1/2	K5205/8X4.1/2
5/8	6"	K5205/8X6

- K521**
- Polotovary
 - Заготовки для резцов из быстрорежущей стали круглого сечения h9
 - Pófabrykat
 - Polotovary

K521	▪	1.1	1.2	1.3	1.4	3.1	3.2	3.3	3.4	6.1	6.2	6.3
	•	1.5	2.1	2.2	6.4	7.1	7.2					

K521 HSS-E   

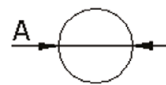
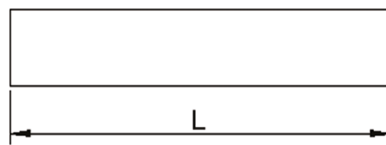

A	L	K521
3	100	K5213.0X100.0
4	100	K5214.0X100.0
5	160	K5215.0X160.0
6	100	K5216.0X100.0
6	160	K5216.0X160.0
8	100	K5218.0X100.0
8	160	K5218.0X160.0
8	200	K5218.0X200.0
10	100	K52110.0X100.0
10	200	K52110.0X200.0
12	100	K52112.0X100.0
12	200	K52112.0X200.0
14	200	K52114.0X200.0
16	200	K52116.0X200.0
20	200	K52120.0X200.0

K522

- Polotovary
- Заготовки для резцов из быстрорежущей стали прямоугольного сечения h13
- Pófabrykat
- Polotovary

K522	▪	1.1	1.2	1.3	1.4	3.1	3.2	3.3	3.4	6.1	6.2	6.3
		•	1.5	2.1	2.2	6.4	7.1	7.2				

K522 HSS-E

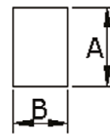
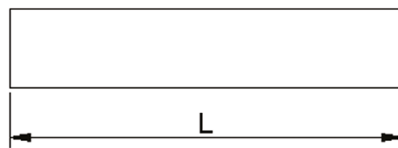

A	B	L	K522
10	3	200	K52210.0X3.0X200.0
12	3	200	K52212.0X3.0X200.0
10	4	200	K52210.0X4.0X200.0
16	4	200	K52216.0X4.0X200.0
20	4	200	K52220.0X4.0X200.0
18	5	200	K52218.0X5.0X200.0
20	5	200	K52220.0X5.0X200.0
10	6	200	K52210.0X6.0X200.0
12	6	200	K52212.0X6.0X200.0
16	6	200	K52216.0X6.0X200.0
20	6	200	K52220.0X6.0X200.0
25	6	200	K52225.0X6.0X200.0
12	8	200	K52212.0X8.0X200.0
16	8	200	K52216.0X8.0X200.0
20	8	200	K52220.0X8.0X200.0
12	10	200	K52212.0X10.0X200.0
16	10	200	K52216.0X10.0X200.0
20	10	200	K52220.0X10.0X200.0
25	12	200	K52225.0X12.0X200.0
25	16	200	K52225.0X16.0X200.0

M150

- Redukční vložka MORSE - tvrzená K=Ext. (externí) K1=Int.
- Переходные втулки с конусом Морзе K=Внеш. K1=Внутр.
- Tulejka mocująca K=Zew.(Zewnetrzny stożek Morse'a) K1=Wew.(Wewnetrzny stożek Morse'a)
- Redukčná vložka Morse K=Ext. K1=Int.



M150



Nr.	K = Nr.	K1 = Nr.	M150
10	1	0	M1501-0
21	2	1	M1502-1
31	3	1	M1503-1
41	4	1	M1504-1
32	3	2	M1503-2
42	4	2	M1504-2
52	5	2	M1505-2
43	4	3	M1504-3
53	5	3	M1505-3
54	5	4	M1505-4
65	6	5	M1506-5

M151

- Redukční vložka MORSE - kalená, broušená
- Шлифованные переходные втулки с конусом Морзе
- Tulejka mocująca hartowana i odpuszczana
- Redukčná vložka Morse brúsená

K=Ext. (externí) K1=Int.

К=Внеш. К1=Внутр.

K=Zew.(Zewnetrzny stożek Morse'a) K1=Wew.(Wewnetrzny stożek Morse'a)

K=Ext. K1=Int.



Nr.	K = Nr.	K1 = Nr.	M151
10	1	0	M1511-0
21	2	1	M1512-1
31	3	1	M1513-1
41	4	1	M1514-1
32	3	2	M1513-2
42	4	2	M1514-2
52	5	2	M1515-2
43	4	3	M1514-3
53	5	3	M1515-3
54	5	4	M1515-4
65	6	5	M1516-5

- M152**
- Vyrážecí klín
 - Клин для раскрепления сверл с конусом Морзе
 - Klin do wybijania wiertel
 - Vyrážač vrtákov



M152



Nr.	M152
0	M1520
1 + 2	M15212
3 + 4	M15234
4 + 5	M15245
6	M1526

M200

- Řezný olej
- Смазочно-охлаждающая жидкость
- Olej chłodząco-smarujący
- Rezný olej



A		M200
1/4 Ltr. 12x	1BLUE	M2000.25NR.1BLUE
1/4 Ltr. 12x	2RED	M2000.25NR.2RED
1/4 Ltr. 12x	3GREEN	M2000.25NR.3GREEN
1 Ltr.	1BLUE	M2001.0NR.1BLUE
1 Ltr.	2RED	M2001.0NR.2RED
1 Ltr.	3GREEN	M2001.0NR.3GREEN
5 Ltr.	1BLUE	M2005.0NR.1BLUE
5 Ltr.	2RED	M2005.0NR.2RED
5 Ltr.	3GREEN	M2005.0NR.3GREEN
20 Ltr.	1BLUE	M20020.0NR.1BLUE



Obecné informace - Český 559 - 578

Общая информация - Русский 579 - 598

Informacje ogólne - Polski 599 - 618

Všeobecné informácie - Slovensky 619 - 638

547 - 640



Běžné ikony / Общие обозначения

Ikony wspólne / Bežné ikony

Materiál Материал Material Materiál	<p>HM</p> <p>Karbid Твердый сплав Węglik Karbid</p>	<p>HSS</p> <p>Rychlořezná ocel Быстрорежущая сталь Stal szybkořnąca Rýchlorezná oceř</p>	<p>HSS-E</p> <p>Rychlořezná ocel s kobaltem Быстрорежущая сталь с кобальтом Stal kobaltowa Rýchlorezná oceř s kobaltem</p>
	<p>HSS-E PM</p> <p>HSS-E ocel práškova metalurgie Порошковая быстрорежущая сталь с кобальтом Stal proszkowa kobaltowa HSS-E oceř práškova metalurgia</p>	<p>HSS HM</p> <p>Rychlořezná ocel/ Karbid Быстрорежущая сталь/ Твердый сплав Stal szybkořnąca/ Węglik Rýchlorezná oceř/Karbid</p>	

Povlak Покрытие Powłoka Povlak	<p>AlCrN</p> <p>Aluminium Chrom Nitrid Хромонитрид алюминия Azotek aluminium chromu Aluminium Chrom Nitrid</p>	<p>Hi</p> <p>Dokončovany leštením Финишное полирование Polerowane Dokončovany leštením</p>	<p>TiSiN</p> <p>Titan Křemík Nitrid Силиконитрид титана Azotek tytanu krzemu Titán Křemík Nitrid</p>	<p>ST</p> <p>Parní temperace Оксидирование Odpuszczanie parowe Parná temperácia</p>
	<p>Bronze</p> <p>Broušený Полирование Niepowlekany Brúsený</p>	<p>Bronze</p> <p>Bronz Бронзовое Brązowiony Bronz</p>	<p>Diamond</p> <p>Diamant Алмазное Diament Diamant</p>	<p>Cr</p> <p>Lesklý chrom Хромирование Jasny Chromowany Lesklý Chrom</p>
	<p>Super B</p> <p>Super B</p>	<p>TiAlN</p> <p>Titan Aluminium Nitrid Алюмонитрид титана Azotek tytanu glinu Titan Aluminium Nitrid</p>	<p>TiCN</p> <p>Titan Carbo Nitrid Карбонитрид титана Węglikoazotek tytanu Titán Karbo Nitrid</p>	<p>TiN</p> <p>Titan Nitrid Нитрид титана Azotek tytanu Titán Nitrid</p>
	<p>ST</p> <p>Broušený/parní temperace Оксидирование с полированием Niepowlekany/Odpuszczanie parowe Brúsený/parná temperácia</p>	<p>TiN</p> <p>Broušený/Titan Nitrid Нитрид титана с полированием Niepowlekany/Azotek tytanu Brúsený/Titán Nitrid</p>	<p>ST Bronze</p> <p>Parní temperace / Bronz Бронзовое с оксидированием Niepowlekany/Brązowiony Parná temperácia/Bronz</p>	<p>TiAlN Top</p> <p>Titan Aluminium Nitrid - Top Алюмонитрид титана Azotek tytanu glinu - Top Titán Aluminium Nitrid - Top</p>
	<p>XCEED</p> <p>Xceed</p>	<p>Ti-phon</p> <p>Ti-phon for Hydra Ti-phon dla Hydry Ti-phon pre Hydry</p>	<p>AlTiCN</p> <p>Aluminium Titan Carbo-nitrid Карбонитрид алюминия и титана Węglikoazotek aluminium tytanu Aluminium Titán Karbo-Nitrid</p>	<p>AlTiN</p> <p>Aluminium Titan Nitrid Алюмонитрид титана Azotek aluminium tytanu Aluminium Titán Nitrid</p>
	<p>Alcrona</p> <p>Alcrona</p>	<p>Alcrona Top</p> <p>Alcrona Top</p>	<p>Alcrona Pro</p> <p>Alcrona Pro</p>	

Popis ikon / Описание обозначений

Opis ikon / Popis ikon

Vežné ikony / Общие обозначения

Ikony wspólne / Vežné ikony

Směr otáčení Направление вращения Kierunek Smer		
	Pravý Правое Prawy Pravý	Levý Левое Lewy Lavý

Hodnocení Применение Zastosowanie Hodnotenie		
	vynikající Основное применение Najlepsze zastosowanie Vynikajúce	dobrý Возможное применение Dobre zastosowanie Dobre

Hĺoubka Глубина Głębokość Hĺbka									

Ikony vrtání / Обозначения для сверления

Ikony wiercenia / Ikony vrtania

Vrcholový úhel Угол при вершине Kąt ostrza Vrcholový uhol								
--	--	--	--	--	--	--	--	--

Úhly navrtání Угол при вершине Kąt nawiercenia Uhly navrtávania				
	Středicí 60° Центровочное отверстие 60° Do nakiełkowania 60° Strediaci 60°	Středicí rádiusový Радиусное центровочное отверстие Do nakiełkowania-łukowy Strediaci rádiusový	Stupňovitý 90° Ступень с углом 90° Wiertło dwustopniowe 90° Stupňovitý 90°	Stupňovitý 180° Ступень с углом 180° Wiertło dwustopniowe 180° Stupňovitý 180°
	Stupňovitý vrták 90° Ступенчатое сверло с углом 90° Wiertło stopniowe 90° Stupňovitý 90°	Stupňovitý vrták 180° Ступенчатое сверло с углом 180° Wiertło stopniowe 180° Stupňovitý 180°		

Typ šroubovice Тип Typ Typ				
	Úhel stoupání šroubovice 21°-34° Угол подъема спирали 21...34° Для общего применения Kąt rowka 21-34 stopni. Wierłta ogólnego stosowania. (głównie stal "P") Uhol skrutkovice 21-34 stup. Použitie pre obrábané mat.skup.P	Úhel stoupání šroubovice 10°-20° Угол подъема спирали 10...20° Для сверления латуни и полимеров Kąt rowka 10-20 stopni. Wierłta do mosiądzu i tworzyw sztucznych. (także inne kruche materiały) Uhol stúpania skrutkovice 10-20 stup. Použitie pre obrábané mat.skupiny N	Úhel stoupání šroubovice 35°-45° Угол подъема спирали 35...45° Для сверления вязких материалов Kąt rowka 35-45 stopni. Wierłta dla grupy "M" do wiercenia precyzyjnego. Uhol stúpania skrutkovice 35-45 stup. Použitie pre obrábané mat.skup.M	Zdokonalený odvod třísky Переменное сечение сверла Pocieniony rdzeń Zdokonalený odvod triesky

Chlazení СОЖ Chłodzenie Chłodzenie	
	Vnitřní chlazení Отверстия для подвода СОЖ Chłodzenie wewnętrzne Vnútročné chlodenie

Ikony vrtání / Обозначения для сверления Ikony-wiercenie / Ikony vrtania

Stopka
Хвостовик
Chwył
Stopka



Válcová stopka
Цилиндрический хвостовик
Chwył cylindryczny
Válcova stopka



Morse kužel
Хвостовик Морзе
Chwył Morse'a
Morse kužel



DIN 6535 HA



DIN 6535 HE



Stopka tang
Хвостовик с лапкой
Chwył z pletwą
Stopka tang



stopka se čtyřhranem
Хвостовик с квадратом
Chwył z kwadratem
Štvorhranná stopka



Redukovaný stopka
Уменьшенный хвостовик
Chwył z redukcją
Redukovaná stopka



DIN 6535 HB
DIN 6535 HE
DIN 6535 HB / HE

Standard
Стандарт
Standard
Standard



NAS
907



DIN
333A



DIN
333R



DIN
338



DIN
340



DIN
341



DIN
345



DIN
1869/1



DIN
1869/2



DIN
1869/3



DIN
1870/1



DIN
1870/2



DIN
1897



DIN
1899



DIN
6537
K



DIN
6537
L



DIN
6539



DIN
8037



DIN
8374



DIN
8376



DIN
8377



DIN
ANSI



BS
328

Popis ikon / Описание обозначений

Opis ikon / Popis ikon

Ikony vystružování a zahlubování / Обозначения для зенковок

Ikony rozwiercania i pogłębiania / Ikony Wystrużowania a Zahlbowania

<p>Kuželovitost Конусность Zbieżność (pochylenie) Kuželový prechod</p>												
<p>Tolerance Допуск Tolerancja Tolerancia</p>		<p>Ø.95-5.5 0,+0.004 Ø5.51-12 0,+0.005</p>										
<p>Použití Применение Zastosowanie Použitie</p>												
<p>Záhlubník Зенкование Pogłębianie Záhlbník</p>	<p>Záhlubník Цекование Pogłębianie czołowe Záhlbník</p>	<p>G314</p>	<p>M138</p>									
<p>Úhel zahloubení Угол зенковки Kąt ostrza pogłębiacza Uhol zahlbenia</p>												
<p>Stopka Хвостовик Chwył Stopka</p>												
<p>Válcová stopka Цилиндрический хвостовик Chwył cylindryczny Válcová stopka</p>	<p>Morse kužel Хвостовик Морзе Chwył Morse'a Morse kužel</p>											
<p>Standard Стандарт Standard Standard</p>		<p>DIN 9</p>	<p>DIN 206</p>	<p>DIN 208</p>	<p>DIN 212</p>	<p>DIN 217</p>	<p>DIN 219</p>	<p>DIN 311</p>	<p>BS 328</p>	<p>DIN 334C</p>	<p>DIN 334D</p>	
		<p>DIN 335</p>	<p>DIN 335A</p>	<p>DIN 335C</p>	<p>DIN 335D</p>	<p>DIN 373</p>	<p>DIN 2179</p>	<p>DIN 2180</p>	<p>DIN 8050</p>	<p>DIN 8051</p>	<p>DIN 8093</p>	<p>DIN 8094</p>
		<p>ANSI</p>										

Ikony závitování / Обозначения для резьбового инструмента
 Ikony gwintowanie / Ikony závitovania

Typ závitu Тип резьбы Typ gwintu Typ závitu	<p>M</p> <p>Metrický Метрическая</p> <p>Metryczny Metrický</p>	<p>MF</p> <p>Metrický jemný Метрическая с мелким шагом</p> <p>Metryczny drobnzwojny Metrický jemný</p>	<p>UNC</p> <p>Unifikovaný palcový závit - hrubý Унифицированная резьба с крупным шагом Gwint amerykański UNC</p>	<p>UNF</p> <p>Unifikovaný palcový závit - jemný Унифицированная резьба с мелким шагом Gwint amerykański drobnzwojny UNF</p>
	<p>UN</p> <p>Unifikovaný palcový závit Унифицированная резьба</p> <p>Gwint amerykański UN</p>	<p>G</p> <p>Trubkový závit Трубная резьба</p> <p>Gwint rurowy walcowy G</p>	<p>NPT</p> <p>Americký kuželový trubkový závit Американская трубная коническая резьба Gwint amerykański rurowy stożkowy NPT</p>	<p>NPTF</p> <p>Americký kuželový trubkový závit - jemný Американская трубная коническая самоуплотняющаяся резьба Gwint amerykański rurowy stożkowy NPTF</p>
	<p>NPSF</p> <p>Americký válcový trubkový závit - jemný Американская трубная цилиндрическая резьба Gwint amerykański rurowy cylindryczny szczelny</p>	<p>NPSM</p> <p>Americký válcový trubkový závit Американская цилиндрическая трубная резьба Gwint amerykański rurowy walcowy</p>	<p>BA</p> <p>Британская стандартная резьба Gwinty British association</p>	<p>BSF</p> <p>Whitworthův závit - jemný Британская стандартная мелкопрофильная резьба Gwint calowy drobnzwojny Whithworta BSF</p>
	<p>BSW</p> <p>Whitworthův závit Британская стандартная резьба Whitworth Gwint calowy Whitwortha BSW</p>	<p>EGM</p> <p>Metrický závit pro závitové vložky Присоединительная резьба Gwinty pod wkładki Heli Coli</p>	<p>PG</p> <p>Pancéřový závit Трубопроводная резьба Gwint do rurek instalacyjnych stalowych Pg</p>	<p>Rc</p> <p>Trubkový kuželový závit vnitřní - EN Резьба внутренняя коническая Gwint rurowy stożkowy Whitwortha</p>

Geometrie drážek Геометрия канавки метчика Geometria ostrza Geometria drążok	<p>Пřímé drážky Прямая канавка Prosty rowek wiógowy Priama drážka</p>	<p>Пřímá drážka, lamač Подточка по заборному конусу Skošna powierzchnia natarcia Lamač triesok, priama drážka</p>	<p>Tvářecí Без стружечной канавки Wygniatk bez rowków smarnych Bezdrážkový</p>	<p>s mazacími drážkami с подводом масла Wygniatk z rowkami smarnymi s mazacími drážkami</p>
	<p>λ 10°</p> <p>Сpirálovité drážky 10° Сpirальная стружечная канавка 10° Skrętny 10° Špiralové drážky 10°</p>	<p>λ 15°</p> <p>Сpirálovité drážky 15°</p>	<p>λ 27°</p> <p>Сpirálovité drážky 27°</p>	<p>λ 30°</p> <p>Сpirálovité drážky 30°</p>
	<p>λ 35°</p> <p>Сpirálovité drážky 35°</p>	<p>λ 40°</p> <p>Сpirálovité drážky 40°</p>	<p>λ 45°</p> <p>Сpirálovité drážky 45°</p>	<p>λ 48°</p> <p>Сpirálovité drážky 48°</p>

Typ díry Тип отверстия Rodzaj otworu Typ Diery	<p>Průchozí díra Сквозное отверстие Otwór przelotowy Priechodzia diera</p>	<p>Slepá díra Глухое отверстие Otwór nieprzelotowy Slepá diera</p>	<p>Průchozí nebo slepá díra Сквозное или глухое отверстие Otwór przelotowy lub nieprzelotowy Priechodzia alebo slepá diera</p>
---	--	--	--

Ikony závitování / Обозначения для резьбового инструмента
 Ikony gwintowanie / Ikony závitovania

Náběhy Заборный конус Nakrój Nábeh	B 3.5-5	C 2-3	C 2-3.5	E 1.5-2
	A 6-8 C 2-3	D 18-20 C 2-3	1.75XP	2.25XP

Náběh B
 Заборный конус типа B 3.5-5 витков
 Nakrój nr B
 Nábeh B

Tolerance Допуск Tolerancja Tolerancia	2A	2B	6G	6GX	6g	6H	6HX	Class A
---	-----------	-----------	-----------	------------	-----------	-----------	------------	----------------

Medium

Střední
 Средний
 Średnia
 Stredná









Normal

Normální
 Нормальный
 Normalny
 Normálna

Stopka Хвостовик Chwył Stopka	DIN 6535HA 	DIN 6535HB
--	--------------------------	--------------------------

Standard Стандарт Standard Standard	DORMER DIN	DORMER ISO	DORMER ANSI	DIN 351	DIN 352	DIN 357	DIN 371	DIN 374	DIN 376	DIN 371≤10 376≥12	DIN 382
	DIN 2174	DIN 2181	DIN 2184-1	ISO 2283	ISO 2284	DIN 5156	DIN 5157	DIN 40432	DIN-EN 22568	ISO 529	ISO 2568
	ANSI	ANSI B94.9	BS 1127: 1950								

Ikony frézování / Обозначения для фрез
 Ikony-frezowanie / Ikony frézovania

Typ Тип Turp Typ	 <p>Polodokončovací lamač třísek Получистовая стружколомающая геометрия Łamacz wióra do obróbki wstępnej Polodokončovací lamač triesok</p>	 <p>Lamač třísek jemný asymetricky zaoblený Стружколомающая геометрия с ассиметричным профилем Łamacz wióra zaokrąglony o asymetrycznym profilu Lamač triesok jemný asymetrický zaoblený</p>	 <p>Fréza pro oceli od nízké po vysokou rezistenci Для обработки конструкционных сталей, в т.ч. высокопрочных Frez do obróbki stali uniwersalny Fréza pre ocele od nízkej po vysokú rezistenciu</p>
	 <p>Lamač třísek s plochou Стружколомающая геометрия с крупным профилем Płaski profil łamacza wióra o dużym skoku Lamač triesok s plochou</p>	 <p>Lamač třísek základní asymetricky zaoblený Ассиметричный профиль с крупным шагом Asymetryczny zaokrąglony profil łamacza wióra o dużym skoku Lamač triesok základný asymetrický zaoblený</p>	 <p>Fréza pro měkké a tvárné materiály Для обработки мягких и вязких материалов Frez przeznaczony do obróbki materiałów miękkich i ciągliwych Fréza pre mäkké a tvárné materiály</p>
	 <p>Lamač třísek Получистовая стружколомающая геометрия Łamacz wióra do obróbki wstępnej Lamač triesok</p>		

Použití Применение Zastosowanie Použitie	 <p>Drážkování P9 Обработка пазов с допуском P9 Rowkowanie w tolerancji P9 Drážkovanie P9</p>	 <p>Drážkování Обработка пазов Rowkowanie Drážkovanie</p>	 <p>Super dokončování Супер-финишная обработка Super wykańczający Super dokončovanie</p>	 <p>Dokončování Чистовая обработка Wykańczający Dokončovanie</p>
	 <p>Hrubování Черновая обработка Obróbka zgrubna Hrubovanie</p>	 <p>Kopírování Копировальная обработка Kulisty Kopírovanie</p>	 <p>rohový radius Торoidalные фрезы Z promieniem naroża Rohový rádius</p>	 <p>Vysokoposuvové frézy Высокоподачные фрезы Wysoki posuw Rychloposuvové frézy</p>
	 <p>Srážení hrany Обработка фасок Ukosowanie Zrážanie hrán</p>	 <p>T-drážky Обработка T-образных пазов Teowy T-drážky</p>	 <p>Woodruff drážky Обработка шпоночных пазов Frez pod wpusty Woodruff drážky</p>	 <p>Rybinovité drážky Обработка пазов "ласточкин хвост" Frez do rowków trapezowych Rybinové drážky</p>
	 <p>Rybinovité drážky inverzní Профиль обратный "ласточкин хвост" Frez do rowków trapezowych - Odwrotny Rybinové drážky inverzní</p>	 <p>Zaoblování Обработка скруглений Frez do zaokrągleń naroży Zaoblovanie</p>	 <p>Stranové a čelní/pilky Обработка пазов Frez tarczowy trzystronny Fréza kotúčová</p>	 <p>Více Универсальная обработка Wielozadaniowy Viac</p>
	 <p>Fréza nástrčná, válcová čelní Насадная торцевая фреза Frezy nasadzane walcowo-czołowe Fréza nástrčná, valcová čelná</p>	 <p>hrubování Черновая насадная торцевая фреза do obróbki zgrubnej hrubovanie</p>		

Ikony frézování / Обозначения для фрез
 Ikony-frezowanie / Ikony frézovania

Směr otáčení Направление обработки Kierunek Smer posuvu				
	Drážkování, šikmé zavrtávání, zavrtávání Обработка пазов и плоскостей, врезание под углом, фрезерование с постепенным засверливанием Rowkowanie, zagłębianie, wiercenie Drážkovanie, šikmé zavrtávanie, zavrtávanie	Drážkování, šikmé zavrtávání Обработка пазов и плоскостей, врезание под углом Rowkowanie, zagłębianie Drážkovanie, šikmé zavrtávanie	Dokončování Фрезерование пазов и уступов Obróbka wykańczająca Dokončovanie	Frézování Цилиндрическое фрезерование Frezowanie Frézovanie

Hĺbka řezu Глубина обработки Długość Hĺbka rezu					
	Extra krátké Сверхкороткая Bardzo krótka Extra krátke		Sředi Средняя Średnia Stredné		Extra dlouhé Сверхдлинная Bardzo długa Dlhé

Tolerance Допуск Tolerancja Tolerancia	d11	e8	h9	h10	h11	h12	k10	k12	js14	js16
---	------------	-----------	-----------	------------	------------	------------	------------	------------	-------------	-------------



e8 celé a půl rozměry, h10 ostatní
 e8 на диаметр или половину диаметра, h10 остальные
 e8 pełne i pół średnice, h10 pozostałe
 e8 celé a pol rozmery, h10 ostatné

Úhel šroubovice/ úhel čela Угол подъема спирали/ передний угол Kať spirali/ Kať natarcia Uhol skrutkovice/ Uhol čela	$\gamma 5^\circ$	$\gamma 15^\circ$	$\gamma 18^\circ$	$\lambda 0^\circ$ $\gamma 0^\circ$	$\lambda \neq$ $\gamma 10^\circ$	$\lambda 10^\circ$ $\gamma 10^\circ$	$\lambda 12^\circ$ $\gamma 10^\circ$	$\lambda 15^\circ$ $\gamma 10^\circ$	$\lambda 15^\circ$ $\gamma 15^\circ$	$\lambda 25^\circ$ $\gamma 0^\circ$	$\lambda 25^\circ$ $\gamma 20^\circ$
	$\lambda 30^\circ$ $\gamma -10^\circ$	$\lambda 30^\circ$ $\gamma 3^\circ$	$\lambda 30^\circ$ $\gamma 9^\circ$	$\lambda 30^\circ$ $\gamma 10^\circ$	$\lambda 30^\circ$ $\gamma 12^\circ$	$\lambda 30^\circ$ $\gamma 15^\circ$	$\lambda 30^\circ$ $\gamma 20^\circ$	$\lambda 35^\circ$ $\gamma 9^\circ$	$\lambda 35^\circ$ $\gamma 12^\circ$	$\lambda 40^\circ$ $\gamma -6^\circ$	$\lambda 40^\circ$ $\gamma 3^\circ$
	$\lambda 40^\circ$ $\gamma 4^\circ$	$\lambda 40^\circ$ $\gamma 10^\circ$	$\lambda 40^\circ$ $\gamma 15^\circ$	$\lambda 40^\circ$ $\gamma 20^\circ$	$\lambda 40^\circ$ $\gamma 25^\circ$	$\lambda 45^\circ$ $\gamma -10^\circ$	$\lambda 45^\circ$ $\gamma 12^\circ$	$\lambda 50^\circ$ $\gamma -26^\circ$	$\lambda 50^\circ$ $\gamma 3^\circ$		

zuby (z) Количество зубьев Ilość ostrzy Zuby (z)	Z 1	Z 2	Z 3	Z 3-4	Z 3-5	Z 3-6	Z 4	Z 4-6	Z 4-8	Z 6-8	Z 6-10
	Z 6-12	Z 8-12	Z 10-12	Z 16-30	Z 28-44	Z 28-100	Z 40-200	Z 80-180	Z 100-140	Z 128-220	Z 160-350



Z 4
 4 zuby - nerovnoměrné členění
 4 зуба - неравномерный шаг
 4 ostrza - nierównomierną podziałką
 4 Zuby - nerovnomerné členenie

Ikony frézování / Обозначения для фрез
Ikony-frezowanie / Ikony frézovania

Stopka
Хвостовик
Chwył
Stopka



Standard
Стандарт
Standard
Standard



Ikony Technické Frézy / Обозначения для борфрез
 Ikony-pilniki obrotowe / Ikony Technická fréza

Použití
 Применение
 Zastosowanie
 Použitie



A

válcová bez čelního břítu
 Цилиндрические без торцевой заточки
 cylindryczny bez ostrzy czolowych
 Valcová bez čelného břitů



B

válcová s čelním břitem
 Цилиндрические с торцевой заточкой
 cylindryczny z ostrzami czolowymi
 valcová s čelním břitom



C

válcová s kulovým čelem
 Цилиндрические со сферическим концом
 cylindryczny z czolem kulistym
 valcová s guľovým čelom



D

kulová
 Сферические
 cylindryczny kulisty
 guľová



E

oválná
 Эллиптические
 ovalny
 ovalna



F

stromečková s kulovým čelem
 Параболические
 łukowy z czolem kulistym
 stromčeková s guľovým čelom



G

stromečková se špičkou
 Параболические заостренные
 łukowy ostry
 stromčeková so špičkou



H

plamínková
 Факелоподобные
 płomykowy
 plamienková



J

60° srážeč
 Конические с углом 60°
 stožkowy 60°
 60° zrzącz



K

90° srážeč
 Конические с углом 90°
 stožkowy 90°
 90° zrzącz



L

kuželová s kulovým čelem
 Конические со сферическим концом
 łukowy zaokrąglony
 kuželová s guľovým čelem



M

kuželová
 Конические
 stožkowy
 kuželová



N

kuželová inverzní
 Конические обратные
 trapezowy
 kuželová inverzná



Sklolaminát, kompozitní materiály
 Для обработки композитных материалов
 obróbka włókna szklanego

Typ
 Тип
 Typ
 Typ

ST

Břit pro obrábění oceli
 Для обработки сталей
 Do wysokowydajnej obróbki stali
 Technické frézy pre použitie na oceľ

VA

Břit pro korozivzdorné oceli
 Для обработки нержавеющей сталей
 Do wysokowydajnej obróbki stali nierdzewnych
 Technické frézy pre použitie na nerez

AL

Břit pro hliník a neželezné materiály včetně plastů
 Для обработки цветных сплавов и полимеров
 Do obróbki metali nieżelaznych i tworzyw sztucznych
 Technické frézy pre použitie na neželezné kovy

GRP

Břit pro sklolamináty a kompozitní materiály
 Для обработки композитных материалов
 Do włókna szklanego i kompozytów
 Technické frézy pre sklolaminát, kompozyty

DC

Dvojitý břit pro všeobecné použití
 Для общего применения
 Do ogólnego zastosowania
 Technické frézy na všeobecné použitie

čelního břítu
 Торцевая заточка
 ostrza czolowe
 Pričné ostrie



Standard
 Стандарт
 Standard
 Standard



Vrtací špička
 С элементом сверла
 Vrták



Frézovací břit
 С элементом концевой фрезы
 Monolitná fréza

Parting off icons / Обозначения в отрезке
Ikony płytek skrawających / Ikony upichowania

Úhel břitu ostří
Угол в плане
при отрезке
Kąt ostrza
Uhol britu
ostria



0°



8° levý / pravý
8° Левый / правый
8° Lewy / Prawy
8° ľavý / pravý



15° levý / pravý
15° Левый / правый
15° Lewy / Prawy
15° ľavý / pravý

Veľkosť destičky
Размер
пластинки
Wymiar płytki
Veľkosť doštičky



23mm



40mm

Směr otáčení
Направление
вращения
Kierunek
Smer otáčania



Pravý
Правое
Prawy
pravý



Levý
Левое
Lewy
ľavý

Použití
Применение
Zastosowanie
Použitie



Upichování
Отрезка
Przecinanie
Upichovanie



Zápichy
Обработка канавок
Rowkowanie
Zápich

Typ
Сечение
Kształt
Typ



Kruhový
Круглое
Okrągły
Kruhový



Čtvercový
Квадратное
Kwadratowy
Štvorcový



Obdélníkový
Прямоугольное
Prostokątny
Obdĺžnikový

Tolerance
Допуск
Tolerancja
Tolerancia



h9



h13

Standard
Стандарт
Standard
Standard



Česky			tvrdost	pevnost v tahu	ISO
skupiny materiálů použití (AMG)			HB	N/mm ²	
1. Ocel	1.1	magneticky měkká	< 120	< 400	P 1
	1.2	konstrukční uhlíkatá	< 200	< 700	P 1
	1.3	uhlíkatá	< 250	< 850	P 2
	1.4	legovaná	< 250	< 850	P 3
	1.5	legovaná, tvrděná a temperovaná	> 250 < 350	> 850 < 1200	P 4
	1.6	legovaná, tvrděná a temperovaná	> 350	> 1200 < 1620	H 1
	1.7	legovaná, tvrděná	49-55HRC	> 1620	H 3
	1.8	legovaná, tvrděná	55-63HRC	> 1980	H 4
2. Nerez	2.1	automatová	< 250	< 850	M 1
	2.2	austenitická	< 320	< 1100	M 3
	2.3	feritická+austenitická	< 300	< 1000	M 2
	2.4	precipitačně tvrděná	>320 <410	>1100 <1400	S 2
3. Litina	3.1	lamelární	< 150	> 500	K 1
	3.2	lamelární	> 150 <300	> 500 < 1000	K 2
	3.3	nodulární	< 200	< 700	K 3
	3.4	nodulární	> 200 < 300	> 700 < 1000	K 4
4. Titan	4.1	čistý	< 200	< 700	S 1
	4.2	slitiny	< 270	< 900	S 2
	4.3	slitiny	> 270 < 350	> 900 ≤ 1250	S 3
5. Nikl	5.1	čistý	< 150	< 500	S 1
	5.2	slitiny	< 270	> 900	S 2
	5.3	slitiny	> 270 < 350	> 900 < 1200	S 3
6. Měď	6.1	bronz	< 100	< 350	N 3
	6.2	β - mosaz, bronz	< 200	< 700	N 4
	6.3	bronz mosaz	< 200	< 700	N 3
	6.4	bronz vysokopevnostní	< 470	< 1500	N 4
7. Hliník, hořčík	7.1	Al, Mg, tvářené	< 100	< 350	N 1
	7.2	Al slitiny, Si < 0.5%	< 150	< 500	N 1
	7.3	Al slitiny, Si > 0.5% < 10%	< 120	< 400	N 1
	7.4	Al slitiny, Si > 10%	< 120	< 400	N 2
8. Syntetické materiály	8.1	termoplasty	---	---	O
	8.2	termosety	---	---	O
	8.3	zpevněné plasty	---	---	O
9. Tvrdé materiály	9.1	cermet (keramika)	< 550	< 1700	H
10. Grafit	10.1	standardní grafit	---	< 100	O

PŘÍKLADY ZNAČENÍ MATERIÁLŮ PODLE
RŮZNÝCH NOREM

AMS	EN	W.Nr.	DIN	BS	SS	USA	UNS	ISO
1.1		1.1015, 1.1013	Rle60, Rle100	230M07, 050A12	1160	Lead Steels	G12120	P 1
1.2	EN 10 025 – S235JRG2	1.1012, 1.1053, 1.7131	S137-2, 16MnCr5, S150-2	060A35, 080M40, 4360-50B	1312, 1412, 1914	135, 30	G10100	P 1
1.3	EN 10 025 – E295	1.1191, 1.0601	CK45, C60	080M46, 080A62	1550, 2142, 2172	1024, 1060, 1061	G10600	P 2
1.4	EN 10 083-1 – 42 CrMo 4 - EN 10 270-2	1.7225, 1.3505, 1.6582, 1.3247	42CrMo4, 100Cr6, 34CrNiMo6, S2-10-1-8	708M40/42, 817M40, 534A99, BM2, BT42	1672-04, 2090, 2244-02, 2541-02	4140, A2, 4340, M42, M2	G41270, G41470, T30102, T11342	P 3
1.5	EN ISO 4857 – H86-5-2 - EN ISO 4857 – H86-5-2.5	1.2510, 1.2713, 1.3247, 1.2080	100MnCrW12, 55NiCrMoV6, X210Cr12, S2-10-1-8	801, BM2, BT142, 826 M40, 830M31	2244-04, 2541-03, 2550, 2722, 2723	01, L6, M42, D3, A2, M2, 4140, 8630	G96300, T30102, T11302, T30403, T11342	P 4
1.6	EN ISO 4857 – HS2-9-1-8	1.2510, 1.2713, 1.3247, 1.2080	100MnCrW12, X210Cr12, S2-10-1-8	801, 826 M40, 830M31	2244-05, 2541-05, , HARDOX 400	01, L6, M42, D3, 4140, 8130	G96300, T30102, T11302, T30403, T11342	H 1
1.7	EN ISO 4857 – HS2-9-1-8	1.2510	100MnCrW4	BO1, BD3, BH13	HARDOX 500		T30403, G41400, J14047	H 3
1.8	EN ISO 4857 – X40CrMoV5-1	1.3343, 1.2344	S6-5-2, GX40CrMoV5-1	BM2, BH13	2242 HARDOX 600			H 4
2.1	EN 10 088-3 – X14CrMoS17	1.4305, 1.4104	X10CrNiSi189, X12CrMoS17	303 S21, 416 S37	2301, 2312, 2314, 2346, 2380	303, 416, 430F	S30300, S41600, S43020	M 1
2.2	EN 10 088-2-0 – 3 – 1, 4301+AT	1.4301, 1.4541, 1.4571	X5CrNi189, X10CrNiMoTi1810	304 S15, 321 S17, 316 S, 320 S12	2310, 2333, 2337, 2343, 2353, 2377	304, 321, 316	S30400, S32100, S31600	M 3
2.3	EN 10 088-3 – 1, 4460	1.4460, 1.4512, 1.4582	X8CrNiMo275, X4CrNiMoNi6257	317 S16, 316 S16	2324, 2387, 2570	409, 430, 436	S40900, S4300, S43600	M 2
2.4	EN 1,4547	1.4547	X2CrNiMo20-18-6	HR41	2378	17-4PH	S31254	S 2
3.1	EN 1561 – EN-JL1030	0.6010, 0.6040	GG10, GG40	Grade150, Grade 400	0120, 0212, 0814	ASTM A48 class 20	F11401, F12801	K 1
3.2	EN 1561 – EN-JL1050	0.6025, 0.6040	GG25, GG40	Grade200, Grade 400	0125, 0130, 0140, 0217	ASTM A48 class 40, STM A48 class 60	F12801, F14101	K 2
3.3	EN 1561 – EN-JL2040	0.7040, 0.7070, 0.8145, 0.8045	GGG40, GGG70, GTS45-06, GTW45-07	420/12, P4407, 700/2, 309/72	0219, 0717, 0727, 0732, 0852	ASTM A220 grade 40010, ASTM A602 grade M4504	F22830, F20001	K 3
3.4	EN 1561 – EN-JL2050	0.7040, 0.7070, 0.8145, 0.8045	GGG40, GGG70, GTS45-06, GTW45-07	420/12, P4407, 700/2, 309/72	0221, 0223, 0737, 0854	ASTM A220 grade 90001, ASTM A602 grade M8501	F26230, 20005	K 4
4.1		3.7024LN	T199.8	TA1 to 9	T199.8	ASTM B265 grade 1	R50250	S 1
4.2		3.7164LN, 3.7119LN	TA16V4, TA165n2	TA10 to 14, TA17	TA16V4, TA165n2	AMS4928	R54790	S 2
4.3		3.7164LN, 3.7174LN, 3.7184LN	TA16V4, TA16V5Sn2, TA14MoSn2	TA10 to 13, TA28	TA16V5Sn2	AMS4928, AMS4971	R56400, R54790	S 3
5.1		2.4060, 2.4066	Nickel 200, 270, N199.6	NA 11, NA12	Ni200, Ni270	Nickel 200, Nickel 230	N02200, N02230	S 1
5.2		2.4630LN, 2.4602, 2.4650LN	Nimonic 75, Monel 400, Hastelloy C, Inconel 600	HR203, 3027-76		Nimonic 75, Monel 400, Hastelloy, Inconel600	N06075, N10002, N04400, N06600	S 2
5.3		2.4668LN, 2.4631LN, 2.6554LN	Inconel 718, Nimonic 80A, Waspaloy	HR8, HR401, 601		Inconel 718, 625, Nimonic 80	N07718, N07080, N06625	S 3
6.1	EN 1652 – CW004A	2.0060, 2.0070	E-Cu57, SE-Cu	C101	5010	101	C10100, C1020	N 3
6.2	EN 1652 – CW612N	2.0380, 2.0360, 2.1030, 2.1080	CuZn39Pb2, CuZn40, CuSn8, CuSn6Zn	CZ120, CZ109/PB104	5168		C28000, C37710	N 4
6.3	EN 1652 – CW508L	2.0321, 2.0260	CuZn37, CuZn28	CZ108, CZ106	5150		C2600, C27200	N 3
6.4			Ampco 18, Ampco 25	AB1 type	5238, JM7-20			N 4
7.1	EN 485-2 – EN AW-1070A	3.0255	A199.5	LMO, 1 B (1050A)	4005	EC, 1060, 1100	A91060, A91100	N 1
7.2	EN 7552 – EN AW-5005	3.1355, 3.3525	AlCuMg2, AlMg2Mn0.8	LM5, 10, 12, N4 (5251)	4106, 4212	380, 520.0, 520.2, 2024, 6061	A03800, A05200, A92024	N 1
7.3	EN 1706 – EN AC-42000	3.2162.05, 3.2341.01	GD-ALSi8Cu, G-ALSi5Mg	LM2.4, 16, 18, 21, 22, 24, 25, 26, 27, L109	4244	319.0, 333.0, 319.1, 356.0	A03190, A03330, C35600	N 1
7.4	SS-EN 1706 – EN AC-47000	3.2581.01	G-ALSi18, G-ALSi12	LM6, 12, 13, 20, 28, 29, 30	4260, 4261, 4262	4032, 222.1, A332.0	A94032, A02220, A13320	N 2
8.1				Polystyrene, Nylon, PVC Cellulose, Acetate & Nitrate		Polystyrene, Nylon, PVC		O
8.2				Ebonite, Tufnol, Bakelite		Bakelite		O
8.3				Kevlar, Pinned Circuit boards		Kevlar		O
9.1				Ferroc, Ferroclitant				H
10.1				Graphite				O

Tabulka řezných rychlostí



		Vc															
m/Min		5	8	10	15	20	25	30	40	50	60	70	80	90	100	110	150
Feet/Min		16	26	32	50	66	82	98	130	165	197	230	262	296	330	362	495
Ø		ot/min															
mm	inch																
1,00		1592	2546	3183	4775	6366	7958	9549	12732	15916	19099	22282	25465	28648	31831	35014	47747
1,50		1061	1698	2122	3183	4244	5305	6366	8488	10610	12732	14854	16977	19099	21221	23343	31831
2,00		796	1273	1592	2387	3183	3979	4775	6366	7958	9549	11141	12732	14324	15916	17507	23873
2,50		637	1019	1273	1910	2546	3183	3820	5093	6366	7639	8913	10186	11459	12732	14006	19099
3,00		531	849	1061	1592	2122	2653	3183	4244	5305	6366	7427	8488	9549	10610	11671	15916
3,18	1/8	500	801	1001	1501	2002	2502	3003	4004	5005	6006	7007	8008	9009	10010	11011	15015
3,50		455	728	909	1364	1819	2274	2728	3638	4547	5457	6366	7276	8185	9095	10004	13642
4,00		398	637	796	1194	1592	1989	2387	3183	3979	4775	5570	6366	7162	7958	8754	11937
4,50		354	566	707	1061	1415	1768	2122	2829	3537	4244	4951	5659	6366	7074	7781	10610
4,76	3/16	334	535	669	1003	1337	1672	2006	2675	3344	4012	4681	5350	6018	6687	7356	10031
5,00		318	509	637	955	1273	1592	1910	2546	3183	3820	4456	5093	5730	6366	7003	9549
6,00		265	424	531	796	1061	1326	1592	2122	2653	3183	3714	4244	4775	5305	5836	7958
6,35	1/4	251	401	501	752	1003	1253	1504	2005	2506	3008	3509	4010	4511	5013	5514	7519
7,00		227	364	455	682	909	1137	1364	1819	2274	2728	3183	3638	4093	4547	5002	6821
7,94	5/16	200	321	401	601	802	1002	1203	1604	2004	2405	2806	3207	3608	4009	4410	6013
8,00		199	318	398	597	796	995	1194	1592	1989	2387	2785	3183	3581	3979	4377	5968
9,00		177	283	354	531	707	884	1061	1415	1768	2122	2476	2829	3183	3537	3890	5305
9,53	3/8	167	267	334	501	668	835	1002	1336	1670	2004	2338	2672	3006	3340	3674	5010
10,00		159	255	318	477	637	796	955	1273	1592	1910	2228	2546	2865	3183	3501	4775
11,11	7/16	143	229	287	430	573	716	860	1146	1433	1719	2006	2292	2579	2865	3152	4298
12,00		133	212	265	398	531	663	796	1061	1326	1592	1857	2122	2387	2653	2918	3979
12,70	1/2	125	201	251	376	501	627	752	1003	1253	1504	1754	2005	2256	2506	2757	3760
14,00		114	182	227	341	455	568	682	909	1137	1364	1592	1819	2046	2274	2501	3410
14,29	9/16	111	178	223	334	446	557	668	891	1114	1337	1559	1782	2005	2228	2450	3341
15,00		106	170	212	318	424	531	637	849	1061	1273	1485	1698	1910	2122	2334	3183
15,88	5/8	100	160	200	301	401	501	601	802	1002	1203	1403	1604	1804	2004	2205	3007
16,00		99	159	199	298	398	497	597	796	995	1194	1393	1592	1790	1989	2188	2984
17,46	11/16	91	146	182	273	365	456	547	729	912	1094	1276	1458	1641	1823	2005	2735
18,00		88	141	177	265	354	442	531	707	884	1061	1238	1415	1592	1768	1945	2653
19,05	3/4	84	134	167	251	334	418	501	668	835	1003	1170	1337	1504	1671	1838	2506
20,00		80	127	159	239	318	398	477	637	796	955	1114	1273	1432	1592	1751	2387
24,00		66	106	133	199	265	332	398	531	663	796	928	1061	1194	1326	1459	1989
25,00		64	102	127	191	255	318	382	509	637	764	891	1019	1146	1273	1401	1910
27,00		59	94	118	177	236	295	354	472	589	707	825	943	1061	1179	1297	1768
30,00		53	85	106	159	212	265	318	424	531	637	743	849	955	1061	1167	1592
32,00		50	80	99	149	199	249	298	398	497	597	696	796	895	995	1094	1492
36,00		44	71	88	133	177	221	265	354	442	531	619	707	796	884	973	1326
40,00		40	64	80	119	159	199	239	318	398	477	557	637	716	796	875	1194
50,00		32	51	64	95	127	159	191	255	318	382	446	509	573	637	700	955

HV	HRC	HB		
Vickers	Rockwell	Brinell	N/ mm ²	Tons/ sq. in.
940	68			
900	67			
864	66			
829	65			
800	64			
773	63			
745	62			
720	61			
698	60			
675	59			
655	58		2200	142
650		618	2180	141
640		608	2145	139
639	57	607	2140	138
630		599	2105	136
620		589	2070	134
615	56	584	2050	133
610		580	2030	131
600		570	1995	129
596	55	567	1980	128
590		561	1955	126
580		551	1920	124
578	54	549	1910	124
570		542	1880	122
560	53	532	1845	119
550		523	1810	117
544	52	517	1790	116
540		513	1775	115
530		504	1740	113
527	51	501	1730	112
520		494	1700	110
514	50	488	1680	109
510		485	1665	108
500		475	1630	105
497	49	472	1620	105
490		466	1595	103
484	48	460	1570	102
480		456	1555	101
473	47	449	1530	99
470		447	1520	98
460		437	1485	96
458	46	435	1480	96
450		428	1455	94
446	45	424	1440	93
440		418	1420	92

HV	HRC	HB		
Vickers	Rockwell	Brinell	N/ mm ²	Tons/ sq. in.
434	44	413	1400	91
423	43	402	1360	88
413	42	393	1330	86
403	41	383	1300	84
392	40	372	1260	82
382	39	363	1230	80
373	38	354	1200	78
364	37	346	1170	76
355	36	337	1140	74
350		333	1125	73
345	35	328	1110	72
340		323	1095	71
336	34	319	1080	70
330		314	1060	69
327	33	311	1050	68
320		304	1030	67
317	32	301	1020	66
310	31	295	995	64
302	30	287	970	63
300		285	965	62
295		280	950	61
293	29	278	940	61
290		276	930	60
287	28	273	920	60
285		271	915	59
280	27	266	900	58
275		261	880	57
272	26	258	870	56
270		257	865	56
268	25	255	860	56
265		252	850	55
260	24	247	835	54
255	23	242	820	53
250	22	238	800	52
245		233	785	51
243	21	231	780	50
240		228	770	50
235		223	755	49
230		219	740	48
225		214	720	47
220		209	705	46
215		204	690	45
210		199	675	44
205		195	660	43
200		190	640	41

Tol	Ø mm							
	> 1 ≤ 3	> 3 ≤ 6	> 6 ≤ 10	> 10 ≤ 18	> 18 ≤ 30	> 30 ≤ 50	> 50 ≤ 80	> 80 ≤ 120
	µm							
e8	-14 / -28	-20 / -38	-25 / -47	-32 / -59	-40 / -73	-50 / -89	-60 / -106	-72 / -126
f6	-6 / -12	-10 / -18	-13 / -22	-16 / -27	-20 / -33	-25 / -41	-30 / -49	-36 / -58
f7	-6 / -16	-10 / -22	-13 / -28	-16 / -34	-20 / -41	-25 / -50	-30 / -60	-36 / -71
h6	0 / -6	0 / -8	0 / -9	0 / -11	0 / -13	0 / -16	0 / -19	0 / -22
h7	0 / -10	0 / -12	0 / -15	0 / -18	0 / -21	0 / -25	0 / -30	0 / -35
h8	0 / -14	0 / -18	0 / -22	0 / -27	0 / -33	0 / -39	0 / -46	0 / -54
h9	0 / -25	0 / -30	0 / -36	0 / -43	0 / -52	0 / -62	0 / -74	0 / -87
h10	0 / -40	0 / -48	0 / -58	0 / -70	0 / -84	0 / -100	0 / -120	0 / -140
h11	0 / -60	0 / -75	0 / -90	0 / -110	0 / -130	0 / -160	0 / -190	0 / -220
h12	0 / -100	0 / -120	0 / -150	0 / -180	0 / -210	0 / -250	0 / -300	0 / -350
k10	+40 / 0	+48 / 0	+58 / 0	+70 / 0	+84 / 0	+100 / 0	+120 / 0	+140 / 0
k12	+100 / 0	+120 / 0	+150 / 0	+180 / 0	+210 / 0	+250 / 0	+300 / 0	+350 / 0
m7	+2 / +12	+4 / +16	+6 / +21	+7 / +25	+8 / +29	+9 / +34	+11 / +41	+13 / +48
js14	+/- 125	+/- 150	+/- 180	+/- 215	+/- 260	+/- 310	+/- 370	+/- 435
js16	+/- 300	+/- 375	+/- 450	+/- 550	+/- 650	+/- 800	+/- 950	+/- 1100
H7	+10 / 0	+12 / 0	+15 / 0	+18 / 0	+21 / 0	+25 / 0	+30 / 0	+35 / 0
H8	+14 / 0	+18 / 0	+22 / 0	+27 / 0	+33 / 0	+39 / 0	+46 / 0	+54 / 0

1µm = 0.001mm

VRTÁNÍ

VŠEOBECNÉ INFORMACE K VRTÁNÍ

1. Zvolte vhodný vrták pro danou operaci podle obráběného materiálu, možností nástroje a chladiva.
2. Vůle mezi součástkou a vřetenem stroje může způsobit poškození vrtáku, součástky i stroje - zajistěte maximální stabilitu celého procesu. Stabilitu zajistíte, zvolíte-li co nejkratší vrták pro danou operaci.
3. Správné upnutí nástroje při vrtání je naprosto zásadní. Vrták nesmí z držáku vyklouznout ani se v něm pohnout.
4. Pro různé operace vrtání jsou vhodné různé řezné kapaliny a chladiva. Používáte-li chladivo či řeznou kapalinu, ujistěte se, že je jich dostatečné množství, především na špičce vrtáku.
5. Aby vrtání mohlo probíhat správně, je nutné zajistit plynulý odvod třísek. Nikdy nedopusťte, aby třísky zůstaly v drážce.
6. Při přebrušování vrtáku dbejte na to, aby se zachovala správná geometrie špičky a veškeré opotřebení bylo odstraněno.

VELIKOST DÍRY

Konfigurace geometrií, substrátu a povlaku jsou stále pokročilejší, a proto se zvyšuje schopnost vrtáků vrtat přesnější díry. Nástroj se standardní geometrií by měl být schopen vyvrtat díru do tolerance H12. Konfigurace vrtáku je dnes mnohem komplexnější, a proto je při vhodných podmínkách možné vrtat díry až do tolerance H8. Pro lepší přehled zde předkládáme seznam výrobků a tolerance děr, jichž je jimi možno dosáhnout:

- Vrtáky pro HSS pro všeobecné použití - H12
- Vrtáky HSS / HSS-E pro vrtání hlubokých děr s parabolickou drážkou - H10
- Vysokorychlostní povlakované vrtáky ze slinutého karbidu – H8/H9

VRTÁNÍ HLUBOKÝCH DĚR

Při vrtání hlubokých děr lze k dosažení požadované hloubky použít několik metod. Níže uvedený příklad uvádí čtyři způsoby, jak vyvrtat díru do hloubky 10 x průměru vrtáku.

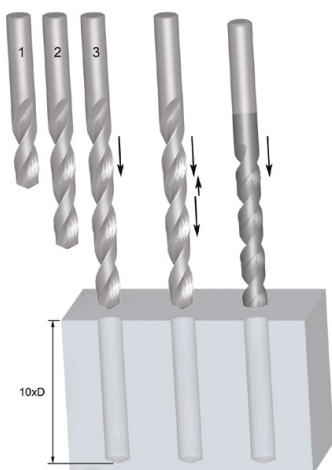

	Postupné vrtání	Postupné vrtání
Počet vrtáků	3 (2,5xD, 6xD, 10xD)	2 (2,5xD, 10xD)
Druh vrtáku	Standardní geometrie, všeobecné použití	Standardní geometrie, všeobecné použití
+ / -	Nákladné Časově náročné	Úspornější Rychlé

	Vrtání s vyjížděním	Vrtání na jeden průchod
Počet vrtáků	1 (10xD)	1 (10xD)
Druh vrtáku	Standardní geometrie, všeobecné použití	Aplikace specifické nástroje
+ / -	Časově náročné	Usporné Rychlé

ŘEŠENÍ PROBLÉMŮ PŘI VRTÁNÍ

PROBLÉM	PŘÍČINA	NÁPRAVA
Zlomený nebo zkroucený unašeč	Špatné spojení mezi stopkou a nástavcem	Ujistěte se, že stopka a nástavec jsou čisté a nepoškozené
Rozlomení jádra	Příliš velký posuv	Zmenšete posuv na optimální hodnotu
	Nedostatečný úhel hřbetu	Přebrušte do požadovaných rozměrů
	Neúměrné ztenčení jádra	Přebrušte do požadovaných rozměrů
	Velké zatížení špičky vrtáku	Vyhnete se nárazům špičky vrtáku. Při vkládání a vyjímání vrtáku s kuželovou stopkou z vřetena postupujte opatrně
Opotřebované vnější břity	Příliš velká rychlost	Snižte rychlost na optimální hodnotu - je možné zvětšit posuv
Vylomené vnější břity	Nestabilní upnutí součástky	Omezte pohyb součástky
Vyštípané břity	Příliš velký podbrus hřbetu	Přebrušte do požadovaných rozměrů
Zlomení na konci drážek u stopky	Ucpávání drážek	Vyzkoušejte vrtání s opětovným vyjžděním vrtáku nebo postupné vrtání několika vrtáky
	Vrták vykluzuje	Zajistěte, aby byl vrták pevně upnut ve sklíčidle a vřetení
Spirálovitá stopa v povrchu díry	Nedostatečný posuv	Zvětšete posuv
	Nepřesné umístění vrtáku	Před vrtáním použijte navrtávák
Příliš velký rozměr díry	Špatná geometrie špičky	Zkontrolujte geometrii špičky
	Neúčinný odvod třísky	Upravte rychlost, posuv a délku vyjždění vrtáku a odvod třísek bude plynulý

VYSTRUŽOVÁNÍ

VŠEOBECNÉ INFORMACE K VYSTRUŽOVÁNÍ

Nejlépeších výsledků s výstružníky dosáhnete, když jim umožníte "pracovat". Nejběžnější chybou, ke které dochází před vystružováním, je předvrtat příliš velkou díru. Pokud je v díře ponecháno nedostatečné množství materiálu, pak výstružník bude drhnout, bude vykazovat předčasné známky opotřebení a průměr se zmenší. Stejně důležité je neponechat v díře příliš velké množství materiálu k obrobení. (Viz obrábění materiálu dole)

1. Zvolte optimální výstružník a optimální rychlost a posuv pro danou operaci. Dbejte na to, aby předvrtané díry měly správný průměr.
2. Součástka musí být pevně upnuta a vřetenem by nemělo vykazovat žádnou vůli.
3. Sklíčidlo, ve kterém je upnuta stopka výstružníku, musí být kvalitní. Pokud výstružník ve sklíčidle prokluzuje a posuv je automatický, může dojít ke zlomení výstružníku.
4. Omezte vyložení z vřetena stroje na minimum.
5. Použijte doporučenou řeznou kapalinu, která prodlužuje trvanlivost výstružníku, a zajistěte, aby se kapalina dostala k břitům. Vystružování nepatří mezi těžké obrábění, a proto obvykle stačí roztok rozpustného oleje v poměru 1:40. Při vystružování šedé litiny - pokud se obrábí na sucho - lze použít stlačený vzduch.
6. Dbejte na to, aby se drážky výstružníku nezanášely třískami.
7. Před přebroušením výstružníku, zkontrolujte koncentricitu mezi hroty. Ve většině případů je třeba přebrousit pouze úkos náběhu.
8. Dbejte na to, aby výstružníky byly ostré. Časté přebroušování je výhodné, ale je dobré vědět, že výstružník řeže pouze úkosem náběhu, ale ne fazetami. Proto je třeba přebroušovat pouze náběh. Přesnost přebroušování je důležitá pro kvalitu díry a pro životnost.

ÚBĚR MATERIÁLU

Doporučený úběr materiálu při vystružování závisí na druhu materiálu a kvalitě povrchu předvrtané díry. Obecné instrukce pro úběr materiálu naleznete v následující tabulce:

Velikost vystružené díry (mm)	S předvrtáním	S předvrtáním výhrubníkem	Velikost vystružené díry (palce)	S předvrtáním	S předvrtáním výhrubníkem
Pod 4	0.1	0.1	Pod 3/16	0.004	0.004
Od 4 do 11	0.2	0.15	Od 3/16 po 1/2	0.008	0.006
Od 11 do 39	0.3	0.2	Od 1/2 po 1 1/2	0.010	0.008
Od 39 do 50	0.4	0.3	Od 1 1/2 po 2	0.016	0.010

MEZNÍ TOLERANCE



1. PRŮMĚRY STANDARDNÍCH VÝSTRUŽNÍKŮ

Průměr (d1) se měří na obvodu fazetky hned za kuželovým náběhem. Tolerance jsou podle normy DIN 1420 a je určen k výrobě děr H7.

TOLERANCE VÝSTRUŽNÍKU			
Průměr (d1)		Mezní tolerance (mm)	
Přes	Do a včetně	Vysoké +	Nízké +
	3	0.008	0.004
3	6	0.010	0.005
6	10	0.012	0.006
10	18	0.015	0.008

TOLERANCE VÝSTRUŽNÍKU			
Průměr (d1)		Mezní tolerance (mm)	
Přes	Do a včetně	Vysoké +	Nízké +
	30	0.017	0.009
30	50	0.021	0.012
50	80	0.025	0.014

2. U DÍRY S TOLERANCÍ H7

Nejběžnější tolerance dokončené díry odpovídá toleranci H7 (viz tabulka dole). Pro určení ostatních tolerančních polí a jejich šíří použijte následující tabulky.

TOLERANCE DÍRY			
Průměr (d1)		Mezní tolerance (mm)	
Přes	Do a včetně	Vysoké +	Nízké +
	3	0.010	0
3	6	0.012	0
6	10	0.015	0
10	18	0.018	0

TOLERANCE DÍRY			
Průměr (d1)		Mezní tolerance (mm)	
Přes	Do a včetně	Vysoké +	Nízké +
	30	0.021	0
30	50	0.025	0
50	80	0.030	0

3. Potřebujete-li najít rozměry speciálního výstružníku, který bude obrábět ve specifických tolerancích, např. D8, můžete použít tento osvědčený návod.

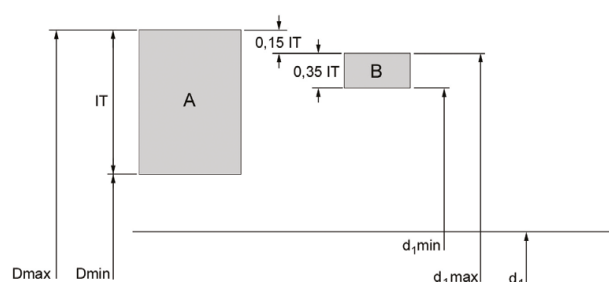

A = Tolerance Díry
 B = Tolerance Výstružníku
 IT = Šířka tolerančního pole
 Dmax = Maximální průměr díry
 Dmin = Minimální průměr díry
 d₁ = Nominální průměr
 d_{1,max} = Maximální průměr výstružníku
 d_{1,min} = Minimální průměr výstružníku

Šířka tolerance (mikrony)	Tolerance průměru (mm)							
	nad 1 vč.3	nad 3 vč. 6	nad 6 vč 10	nad 10 vč. 18	nad 18 vč. 30	nad 30 vč. 50	nad 50 vč. 80	nad 80 vč. 120
IT5	4	5	6	8	9	11	13	15
IT6	6	8	9	11	13	16	19	22
IT7	10	12	15	18	21	25	30	35
IT8	14	18	22	27	33	39	46	54
IT9	25	30	36	43	52	62	74	87
IT10	40	48	58	70	84	100	120	140
IT11	60	75	90	110	130	160	190	220
IT12	100	120	150	180	210	250	300	350

např. díra o 10 mm s tolerancí D8, max. průměr = 10,062, min. průměr = 10,040, tolerance díry IT8 = 0,022

Maximální limit: 0,15 x tolerance díry (IT8) = 0,0033 zaokrouhloeno = 0,004

Minimální limit: 0,35 x tolerance díry (IT8) = 0, 0077, zaokrouhloeno na 0,008

Maximální limit pro výstružník = 10,062 - 0,004 = 10,058

Minimální limit pro výstružník = 10,058 - 0,008 = 10,050

ŘEŠENÍ PROBLÉMŮ PŘI VYSTRUŽOVÁNÍ

PROBLÉM	PŘÍČINA	NÁPRAVA
Zlomený nebo zkroucený unašeč	Špatné spojení mezi stopkou a nástavcem	Ujistěte se, že stopka i nástavec jsou čisté a nepoškozené
Rychlé opotřebení nástroje	Nedostatečné množství materiálu k obrábění	Zvětšete objem materiálu k obrobení
Nadměrná díra	Rozhození průměru břitů	Přebruste podle správných specifikací
	Špatné upnutí do vřetena stroje	Opravte a správně nastavte vřeteno
	Ohyb v nástrojovém držáku	Vyměňte nástrojový držák
	Stopka nástroje je poškozena	Vyměňte či přebrušte stopku
	Nástroj vykazuje oválnost	Vyměňte nebo přebrušte nástroj
	Asymetrický úhel náběhu	Přebruste podle správných specifikací
	Příliš velký posuv nebo rychlost	Upravte řezné podmínky podle katalogu
Undersize hole	Nedostatečné množství materiálu k obrábění	Zvětšete objem materiálu k obrobení
	Při vystružování vznikají příliš vysoké teploty. Díra se rozšiřuje a smršťuje	Zvyšte průtok chladiva
	Průměr nástroje je menší a nástroj opotřebovaný	Přebruste podle správných specifikací
	Příliš malý posuv a nízká řezná rychlost	Upravte řezné podmínky podle katalogu
	Předvrtaná díra je příliš malá	Uberte množství materiálu k obrobení
Oválné a kónické díry	Špatné upnutí do vřetena stroje	Opravte a správně nastavte vřeteno
	Nesouosost mezi dírou a nástrojem	Použijte výstružník na nýtové spoje
	Asymetrický úhel náběhu	Přebruste podle správných specifikací
Špatná kvalita povrchu díry	Příliš mnoho materiálu k obrobení	Uberte množství materiálu k obrobení
	Opotřebovaný nástroj	Přebruste podle správných specifikací
	Příliš malý úhel čela	Přebruste podle správných specifikací
	Příliš řídká emulze nebo řezný olej	Zvyšte koncentraci
	Posuv a/nebo rychlost příliš nízká	Upravte řezné podmínky podle katalogu
	Řezná rychlost příliš vysoká	Upravte řezné podmínky podle katalogu
Nástroj je upnut a zlomí se	Opotřebovaný nástroj	Přebruste podle správných specifikací
	Zpětný kužel nástroje je příliš malý	Zkontrolujte a vyměňte/upravte nástroj
	Šířka lůžka je příliš velká	Zkontrolujte a vyměňte/upravte nástroj
	Materiál součástky se stlačuje	Kompenzujte vychýlení tím, že použijte nastavitelný výstružník
	Předvrtaná díra je příliš malá	Uberte množství materiálu k obrobení
	Heterogenní materiál s tvrdými inkluzemi	Použijte výstružník ze slinutého karbidu

FRÉZOVÁNÍ ZÁVITŮ

OBECNÉ POZNÁMKY K FRÉZOVÁNÍ ZÁVITŮ

Při frézování závitů se závit vyrábí prostřednictvím šroubovicové interpolace frézy se speciální geometrií závitu na svém obvodu.

Pro použití závitové frézy je nutné mít k dispozici CNC obráběcí stroj schopný provádět kruhové dráhy.

Většina moderních CNC strojů je vybavena obráběcími cykly pro frézování závitů.

Více informací získáte v uživatelské příručce nebo kontaktujte přímo dodavatele stroje.

VLASTNOSTI A VÝHODY

Frézování závitů zvyšuje spolehlivost a životnost nástroje.

Při frézování závitu vznikají malé třísky, a výroba závitu je tak bezproblémová.

Nastavení tolerance lze provádět na základě přesných souřadnic.

Závit lze vyrobít až do dna otvoru.

Lze obrábět širokou paletu materiálů.

Stejnou frézou lze vyrábět různé rozměry závitů za předpokladu, že stoupání zůstává stejné.

Stejným nástrojem lze vyrábět levé i pravé závit.

Některé závitové frézy jsou schopné vyrobít rovněž vstupní zkosení závitu (J200, J205, J260).

VÝBĚR NÁSTROJE

Všechny závitové frézy jsou označeny kódem produktu určujícím typ, průměr (d_1) a stoupání (P).

Při objednávání nástroje se používá kód položky.

Vždy si prostudujte katalog, abyste se ujistili, že máte správné rozměry závitu.

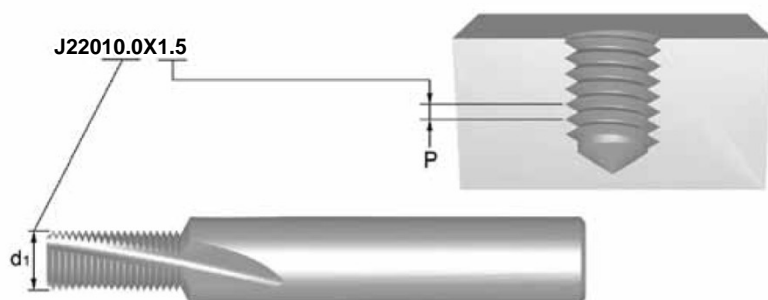

Tuto závitovou frézou lze použít pro závit $\geq M12 \times 1,5$ ($M14 \times 1,5$, $M18 \times 1,5$ atp.).

PROGRAMOVÁNÍ POMOCÍ Rprg

- Pro snadné nastavení tolerance závitů vždy do programu zadávejte korekci poloměru.
- Hodnota Rprg je výchozí hodnotou pro novou frézu a je vytištěna na její stopce. Je třeba ji zadat do paměti ofsetu nástroje.
- Rprg vychází z teoretické nulové linie závitů, což znamená, že použijete-li k programování hodnotu Rprg, nebude závit nikdy příliš velký a bude mít normální těsnost.
- Znamená to, že prostřednictvím malé úpravy souřadnic programu můžete vyrábět závit požadovaných rozměrů.

DOPORUČENÍ

- Vždy používejte správné řezné podmínky
- Pro průměr závitů používejte doporučené velikosti vrtáků, stejně jako u běžných závitníků.
- Pro snadné nastavení tolerance závitů vždy začněte hodnotou Rprg vytištěnou na stopce závitové frézy.
- Při prvním závitě použijte měřidlo pro kontrolu tolerance a potom pravidelně kontrolujte, zda je třeba poloměr upravit. Do plného opotřebení závitové frézy bude obvykle zapotřebí poloměr korigovat 2–3×.
- Při suchém obrábění se pro snazší odstraňování třísky doporučuje použití stlačeného vzduchu.
- Při řezání závitů do obtížněji obrobitelných materiálů je vhodné použít dva nebo tři průchody.

ŘEZÁNÍ ZÁVITŮ

VŠEOBECNÉ INFORMACE K ŘEZÁNÍ ZÁVITŮ

Úspěch při řezání závitů závisí na několika různých faktorech, které ovlivňují kvalitu výrobku.

1. Zvolte správný tvar závitníku podle materiálu součástky a typu díry např. průchozí nebo slepé, podle Tabulky klasifikace materiálů.
2. Dbejte na to, aby součástka byla řádně upnutá, při pohybu do stran se závitník může zlomit a kvalita závitů může být špatná.
3. Zvolte správnou velikost závitníku podle katalogu. Dbejte na to, aby nežádoucí vytvrzování materiálu součástky bylo minimální.
4. Zvolte správnou řeznou rychlost podle katalogu.
5. Použijte vhodný řezný olej pro danou operaci.
6. Při NC operacích se ujistěte, že naprogramovaná velikost posuvu je správná. Použijte-li pružné upnutí, zvolte 95% až 97% stoupání závitu, aby byl závitník vlastním stoupáním tažen do řezu.
7. Pokud je to možné, upněte závitník do upínače, který umožňuje hlídat krouticí moment a zajistí volný axiální pohyb závitníku v díře. Závitník se tím také chrání před zlomením, pokud by náhodou neplánovaně narazil na dno díry.
8. Zajistěte plynulý vstup závitníku do díry, nerovnoměrný posuv může způsobit rozhození při nájezdu do závitu.

TABULKA TOLERANCE ZÁVITNÍKU OPROTI TOLERANCI VNITŘNÍHO ZÁVITU (MATICE)

Třída tolerance, závitník			Tolerance, vnitřní závit (matice)					Použití
ISO	DIN	ANSI BS						
ISO 1	4 H	3 B	4 H	5 H				Uložení bez vůle
ISO 2	6 H	2 B	4 G	5 G	6 H			Normální uložení
ISO 3	6 G	1 B			6 G	7 H	8 H	Uložení s velkou vůlí
-	7 G	-				7 G	8 G	Volné uložení pro následnou povrchovou úpravu nebo povlakování

ŘEŠENÍ PROBLÉMŮ PŘI ZÁVITOVÁNÍ

PROBLÉM	PŘÍČINA	NÁPRAVA
Volný závit	Nesprávná tolerance	Zvolte závitník s těsnější tolerancí
	Nesprávný axiální posuv	Snižte posuv o 5 - 10% (v pružné hlavě) nebo zvýšte tlak upínače
	Nevhodný typ závitníku pro aplikaci	Pro průchozí díry použijte závitník s přímou drážkou a lamačem, pro slepé díry použijte spirálovitý závitník. Povlakovaným nástrojem snížíte možnost tvorby nárůstku. Provéřte alternativní produkty v Selectoru nebo katalogu
	Závitník není v díře vystředěný	Zkontrolujte upínač a pozici, musí být v ose díry
	Nedostatečná lubrikace	Použijte kvalitní lubrikant, který předejde zasekávání třísek v díře. Viz kapitola o lubrikaci v technické příručce
	Řezná rychlost příliš nízká	Dodržujte doporučení z katalogu nebo Selectoru
Těsný závit	Nevhodný typ závitníku pro aplikaci	Pro průchozí díry použijte závitník s přímou drážkou a lamačem, pro slepé díry použijte spirálovitý závitník. Povlakovaným nástrojem snížíte možnost tvorby nárůstku. Použijte závitník s větším úhlem čela. Provéřte alternativní produkty v Selectoru nebo katalogu
	Nesprávná tolerance	Zvolte závitník s volnější tolerancí, obzvláště do materiálů, které mají tendenci ke smršťování (nerez), nebo abrazivních materiálů (litina)
	Nedostatečná nebo nevhodná lubrikace	Použijte kvalitní lubrikant, který předejde zasekávání třísek v díře. Viz kapitola o lubrikaci v technické příručce
	Předvrtaná díra příliš malá	Zvětšete průměr vrtáku na maximální hodnotu. Zkontrolujte průměr předvrtané díry.
	Materiál se po závitování stahuje	Zkontrolujte doporučené parametry v katalogu nebo Selectoru a vhodné alternativy
Zasekávání třísek	Nevhodný typ závitníku pro danou operaci	Zvolte závitník s menším úhlem čela. Zvolte závitník s delším náběhem. Do průchozích děr používejte závitník s přímou drážkou, do slepých spirálovitě, zabráníte zasekávání třísek. Zkontrolujte v katalogu nebo Selectoru alternativní vhodné závitníky
	Nevhodná nebo nedostatečná lubrikace	Použijte kvalitní lubrikant, který předejde zasekávání třísek v díře. Viz kapitola o lubrikaci v technické příručce
	Závitník naráží do dna	Zvyšte hloubku vrtání nebo snižte hloubku závitování
	Povrch díry se obráběním vytvrzuje	Snižte řeznou rychlost, použijte vhodný lubrikant. Viz kapitola o obrábění nerez v technické příručce
	Zasekávání třísek při výjezdu	Vyvarujte se prudkých změn otáček při reverzaci
	Úkos naráží do vchodu do díry	Zkontrolujte axiální polohu a snižte odchylku od osy na minimum
	Předvrtaná díra příliš malá	Zvětšete průměr vrtáku na maximum. Zkontrolujte průměr předvrtané díry.

ŘEŠENÍ PROBLÉMŮ PŘI ZÁVITOVÁNÍ

PROBLÉM	PŘÍČINA	NÁPRAVA
Zlomení	Otupený závitník	Použijte nový závitník nebo přebroušte otupený
	Nedostatečná lubrikace	Použijte kvalitní lubrikant, který předejde zasekávání třísek v díře. Viz kapitola o lubrikaci v technické příručce
	Závitník naráží do dna díry	Zvyšte hloubku vrtání nebo snižte hloubku závitování
	Řezná rychlost příliš vysoká	Snižte řeznou rychlost. Dodržujte doporučení z katalogu nebo Selectoru
	Povrch se obráběním vytvrzuje	Snižte rychlost. Použijte povlakovaný nástroj. Použijte kvalitní lubrikant. Viz kapitola o obrábění nerezů v technické příručce
	Předvrtaná díra příliš malá	Zvětšete průměr vrtáku na maximum. Viz tabulky vrtáků pod závit
	Vysoký krouticí moment	Použijte závitovací hlavu s nastavením krout. momentu
	Materiál se po závitování stahuje	Zkontrolujte doporučení v katalogu nebo Selectoru, najděte vhodný typ závitníku
Rychlé opotřebování	Nevhodný typ závitníku na danou aplikaci	Zvolte závitník s menším úhlem čela. Zvolte závitník s delším náběhem. Do průchozích děr použijte závitník s přímou drážkou, do slepých spirálovitých, zabráníte zasekávání třísek. Zkontrolujte v katalogu nebo Selectoru alternativní vhodné závitníky
	Nedostatečná lubrikace	Použijte kvalitní lubrikant, který předejde zasekávání třísek v díře a teplotnímu zatížení břitu. Viz kapitola o lubrikaci v technické příručce
	Řezná rychlost příliš vysoká	Snižte řeznou rychlost. Dodržujte doporučení z katalogu nebo Selectoru
Nárůstek	Nevhodný typ závitníku na danou aplikaci	Použijte závitník s menším úhlem čela nebo/a větším odlehčením zubů. Zkontrolujte katalog nebo Selector, najděte vhodný nástroj
	Nedostatečná lubrikace	Použijte kvalitní lubrikant, který předejde zasekávání třísek v díře a teplotnímu zatížení břitu. Viz kapitola o lubrikaci v technické příručce
	Nevhodná povrchová úprava	Použijte závitník s vhodným povlakem.
	Řezná rychlost příliš nízká	Dodržujte doporučení z katalogu nebo Selectoru

FRÉZOVÁNÍ

VŠEOBECNÉ POKYNY PRO FRÉZOVÁNÍ

Frézování je proces, kdy je odebírán stanovený přídavek materiálu frézou, která rotuje kolem své osy a zároveň se posouvá do řezu.

Fréza je obvykle vícebřítý nástroj, kde každý břit odebírá materiál

TYPY FRÉZ

Rozlišujeme tři základní druhy frézovacích operací a tím i druhů fréz: (A) obvodové frézování, (B) čelní frézování a (C) frézování stopkovými frézami.

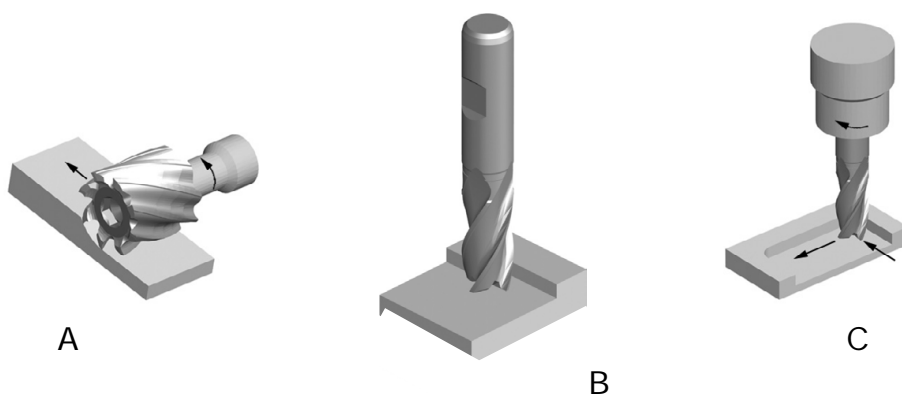

Při obvodovém frézování válcovými frézami je osa rotace nástroje rovnoběžná s povrchem obráběné součásti. Fréza má po obvodu určitý počet zubů, každý z těchto zubů funguje stejně jako jednobřítý nástroj. Válcové frézy mohou mít přímé zuby nebo zuby šroubovicové.

Při čelním frézování je osa otáčení frézy kolmá na povrch obráběné součásti. Frézování probíhá na břitech, které jsou na čele a na obvodu frézy. Při frézování stopkovými frézami je osa frézy vertikálně kolmá na povrch obrobku a obvykle může frézovat všemi směry, které jsou na čele i na obvodu frézy.

POUŽITÍ

Druh obráběcí operace přímo souvisí s hodnotou Q. Různé aplikace umožňují dosahovat různých hodnot Q. Aktuální katalog Dormer ukazuje prostřednictvím jednoduchých ikon použití fréz.

Frézování bokem	Čelní frézování	Drážkování	Zavrtávání	Zavrtávání po rampě
Radiální hloubka by měla být menší než 0,25 x průměr frézy.	Radiální hloubka by neměla být vyšší než 0,9 x průměr frézy, axiální hloubka řezu méně než 0,1 x průměr.	Obrábění drážek na pera. Radiální hloubka je rovna průměru frézy.	Zavrtávání je možné s frézami, které mají břit přes střed. V těchto operacích je třeba snížit posuv na polovinu.	Rampování, radiální i axiální nájezd do materiálu.

ŘEŠENÍ PROBLÉMŮ PŘI FRÉZOVÁNÍ

PROBLÉM	PŘÍČINA	NÁPRAVA
Zlomení	Příliš velký přídavek materiálu	Snižte posuv na zub
	Příliš velký posuv	Snižte posuv
Opotřebení	Délka pracovní části nebo celková délka příliš dlouhá	Upněte tak, aby fréza zbytečně nečouhala z upínače nebo použijte kratší frézu
	Příliš tvrdý materiál obrobku	Zkontrolujte katalog nebo Selector, zda je v nabídce odolnější nástroj nebo nástroj s povlakem
	Nesprávná řezná rychlost a posuv	Zkontrolujte řezná data v katalogu nebo Selectoru
	Špatný odvod třísek	Zamiřte trysky s chlazením
	Nesousledné frézování	Sousledné frézování
	Nevhodná šroubovice	Zkontrolujte doporučení v katalogu/Selectoru a alternativní nástroje
Vylamování	Příliš velký posuv	Snižte posuv
	Vylamování	Snižte řeznou rychlost
	Nízká řezná rychlost	Zvyšte řeznou rychlost
	Nesousledné frézování	Sousledné frézování
	Tuhost nástroje	Vyberte kratší frézu nebo stopku zasuňte hlouběji do upínače
	Tuhost obrobku	Pevně upněte obrobek
Krátká životnost	Houževnatý materiál obrobku	Zkontrolujte katalog nebo Selector a vyberte alternativní frézu
	Nevhodná geometrie břítu	Zadejte správná řezná data
	Tření mezi frézou a povrchem obrobku	Použijte povlakovaný nástroj
Špatná kvalita povrchu	Příliš velký posuv	Snižte řeznou rychlost
	Nízký posuv	Zvyšte řeznou rychlost
	Zasekávání třísek	Zmenšete přídavek materiálu
	Opotřebení nástroje	Vyměňte nebo přebrušte nástroj
	Tvorba nárůstku	Zvolte frézu s větším úhlem šroubovice
	Nalepování třísek	Zvyšte intenzitu chlazení

PROBLÉM	PŘÍČINA	NÁPRAVA
Nepřesnost obrobku	Ohyb nástroje	Zvolte kratší nástroj nebo zasuňte stopku hlouběji do upínače
	Nedostatečný počet drážek (zubů)	Zvolte nástroj s více drážkami (zuby)
	Uvolněný, opotřeбенý upínač	Opravte nebo vyměňte
	Nedostatečná tuhost upínače	Vyměňte za kratší a tužší upínač
	Nedostatečná tuhost vřetene	Použijte stroj z vyšší tuhostí
Vylamování	Řezná rychlost a posuv příliš vysoké	Změňte řezná data za pomoci katalogu/Selectoru
	Délka pracovní části nebo celková délka nástroje příliš dlouhá	Zasuňte stopku hlouběji do upínače a použijte kratší frézu
	Příliš velká hloubka obrábění	Snižte hloubku řezu
	Nedostatečná tuhost (stroj nebo upínač)	Zkontrolujte upínač a je-li třeba, vyměňte jej

KARBIDOVÉ FRÉZY

OBECNÉ POZNÁMKY KE KARBIDOVÝM FRÉZÁM

Karbidové frézy se hojně užívají pro přípravu a dokončování součástek v široké paletě materiálů.

Používají se typicky v ručních pneumatických bruskách.

VLASTNOSTI A VÝHODY

Tvrzené a kalené ocelové stopky zlepšují tuhost a snižují nebezpečí ohnutí a vibrací.

Přesně vybroušené stopky zlepšují držení a snižují riziko prokluzu.

Speciální pájení brání závadám způsobeným vysokými teplotami a zajišťuje rovněž vyšší pevnost umožňující jim odolat tlaku a nárazu.

Univerzální geometrie Double Cut je vhodná pro široké spektrum materiálů a aplikací.

Existují rovněž speciální geometrie pro různé materiály vhodné pro ocel (ST), korozivzdornou ocel (VA), hliník (AL) a sklolaminát (GRP)

Jsou vybaveny TiAlN povlakováním zvyšujícím životnost nástroje při práci v abrazivních materiálech.

Válcové frézy s kulovým čelem jsou vybroušeny na geometrii Skip Flute (s vynecháním drážky).

Díky tomu vzniká aktivní geometrie u středu frézy, což zlepšuje záběr a snižuje riziko nahromadění třísek a ucpání.

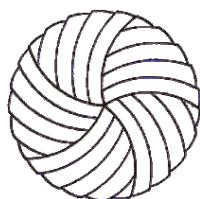

Skip

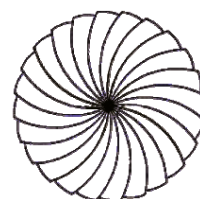

Normální

BEZPEČNOST PŘEDEVŠÍM

Vysokorychlostní rotační nástroje mohou být při nesprávném použití nebezpečné.

Před výměnou frézy vždy odpojte ruční brusku od přívodu stlačeného vzduchu.

Zkontrolujte stav brusky, a pokud je to možné, používejte typy s nízkými vibracemi.

Vždy používejte vhodné ochranné pomůcky a zajistěte rovněž ochranu osob pracujících v blízkosti.



Za všech okolností je třeba používat osobní ochranné pomůcky.

DOPORUČENÍ

Vždy používejte ruční brusku s vhodnou rychlostí otáčení.

Běžná údržba brusek je důležitá, zajistěte, že jsou dobře promazány a ložiska nejsou opotřebovaná.

Při výměně frézy vždy očistěte upínací matici, pouzdro a vnitřní kužel brusky.

Snažte se předcházet nárazům a tvrdým úderům do fréz.

Snažte se předcházet teplotnímu šoku fréz tím, že zabráníte jejich přehřátí.

Nezanořujte frézu příliš hluboko do obrobku ani ji nezarážejte do rohů či štěrbin.

Řešení problémů při POUŽITÍ FRÉZ

PROBLÉM	PŘÍČINA
Vylamování zubů frézy	Běh při příliš nízkých otáčkách může vyvolat odskakování
	Nevystředěnost (opotřebované vřeteno, pouzdro nebo ložiska)
	Zanořování a zarážení frézy do obrobku
Ucpávání zubů frézy	Přílišná délka štěrbin nebo celého nástroje
	Nesprávně zvolená geometrie pro daný materiál obrobku
Předčasné opotřebení	Provoz při příliš vysokých otáčkách frézy vzhledem k materiálu obrobku
	Nevystředěnost (opotřebované vřeteno, pouzdro nebo ložiska)
Hlavice se odděluje od stopky	Příliš vysoké otáčky vedou k přehřátí
	Dlouhodobý provoz vede k přehřátí

Русский		Твердость	Предел прочности	ISO
Группы обрабатываемых материалов (AMG)		HB	N/mm ²	
1. Сталь	1.1 Автоматная сталь	< 120	< 400	P 1
	1.2 Низкоуглеродистая сталь	< 200	< 700	P 1
	1.3 Углеродистая нелегированная сталь	< 250	< 850	P 2
	1.4 Легированная сталь	< 250	< 850	P 3
	1.5 Легированная сталь после отжига	> 250 < 350	> 850 < 1200	P 4
2. Нержавеющая сталь	1.6 Высоколегированная сталь после отжига	> 350	> 1200 < 1620	H 1
	1.7 Легированная закаленная сталь	49-55HRC	> 1620	H 3
	1.8 Легированная закаленная сталь	55-63HRC	> 1980	H 4
	2.1 ферритная нержавеющая сталь	< 250	< 850	M 1
	2.2 аустенитная нержавеющая сталь	< 320	< 1100	M 3
	2.3 ферритно-аустенитная нержавеющая сталь	< 300	< 1000	M 2
	2.4 Сталь дисперсионного твердения	>320 <410	>1100 <1400	S 2
	3.1 Серый чугун	< 150	> 500	K 1
3. Чугун	3.2 Ковкий чугун	> 150 <300	> 500 < 1000	K 2
	3.3 Высокопрочный чугун	< 200	< 700	K 3
4. Титан	3.4 Высокопрочный чугун	> 200 < 300	> 700 < 1000	K 4
	4.1 Технически чистый титан	< 200	< 700	S 1
	4.2 Титановые сплавы	< 270	< 900	S 2
5. Никель	4.3 Титановые сплавы	> 270 < 350	> 900 ≤ 1250	S 3
	5.1 Технически чистый никель	< 150	< 500	S 1
	5.2 Никелевые сплавы	< 270	> 900	S 2
6. Медь	5.3 Никелевые сплавы	> 270 < 350	> 900 < 1200	S 3
	6.1 Технически чистая медь	< 100	< 350	N 3
	6.2 Бронза	< 200	< 700	N 4
	6.3 Латунь	< 200	< 700	N 3
7. Алюминий, магний	6.4 Высокопрочная бронза	< 470	< 1500	N 4
	7.1 Технически чистый алюминий/магний	< 100	< 350	N 1
	7.2 Сплавы Al с содержанием Si < 0.5%	< 150	< 500	N 1
	7.3 Сплавы Al с содержанием 0.5% < Si < 10%	< 120	< 400	N 1
8. Полимеры	7.4 Сплавы Al с содержанием Si > 10%	< 120	< 400	N 2
	8.1 Термопластики	---	---	O
9. Твердые материалы	8.2 Термореактивные полимеры	---	---	O
	8.3 Армированные полимеры	---	---	O
	9.1 Металлокерамика	< 550	< 1700	H
10. Графит	10.1 Технический графит	---	< 100	O

ПРИМЕРЫ ОБРАБАТЫВАЕМЫХ МАТЕРИАЛОВ
ПО СТАНДАРТАМ РАЗНЫХ СТРАН

AMG	EN	W.Nr.	DIN	BS	SS	USA	UNS	ISO
1.1		1.1015, 1.1013	Rf60, Rf6100	230Mn7, 050A12	1160	Leaded Steels	G12120	P 1
1.2	EN 10 025 - S235JRG2	1.1012, 1.1053, 1.17131	S137-2, 16MnCr5, S150-2	060A35, 080M40, 4360-50B	1312, 1412, 1914	135, 30	G10100	P 1
1.3	EN 10 025 - E295	1.1191, 1.0601	CK45, C60	080M46, 080A62	1550, 2142, 2172	1024, 1060, 1061	G10600	P 2
1.4	EN 10 083-1 - 42 CrMo 4 - EN 10 270-2	1.7225, 1.3505, 1.6582, 1.3247	42CrMo4, 100Cr6, 34CrNiMo6, S2-10-1+8	708M40/42, 817M40, 534A99, BM2, BT42	1672-04, 2090, 2244-02, 2541-02	4140, A2, 4340, M42, M2	G41270, G41470, T30102, T11342	P 3
1.5	EN ISO 4957 - HS6-5-2 - EN ISO 4957 - HS6-5-25	1.2510, 1.2713, 1.3247, 1.2080	100MnCrW12, 5NiCrMoV6, X210Cr12, S2-10-1+8	B01, BM2, BT42, 826 M40, 830M31	2244-04, 2541-03, 2550, 2722, 2723	01, L6, M42, D3, A2, M2, 4140, 8630	G86300, T30102, T11302, T30403, T11342	P 4
1.6	EN ISO 4957 - HS2-9-1+8	1.2510, 1.2713, 1.3247, 1.2080	100MnCrW12, X210Cr12, S2-10-1+8	801, 826 M40, 830M31	2244-05, 2541-05, ,HARDFOX 400	01, L6, M42, D3, 4140, 8130	T30403, G41400, J14047	H 1
1.7	EN ISO 4957 - HS2-9-1+8	1.2510	100MnCrW12	B01, BD3, BH13	HARDFOX 500			H 3
1.8	EN ISO 4957 - X40CrMoV5-1	1.3343, 1.2344	S6-5-2, GX40CrMoV5-1	BM2, BH13	2242 HARDFOX 600			H 4
2.1	EN 10 088-3 - X14CrMoS17	1.4305, 1.4104	X10CrNiS189, X12CrMoS17	303 S21, 416 S37	2301, 2312, 2314, 2346, 2380	303, 416, 430F	S30300, S41600, S43020	M 1
2.2	EN 10 088-2-0-3 - 1.4301+AT	1.4301, 1.4541, 1.4571	X5CrNi189 X10CrNiMoTi1810	304 S15, 321 S17, 316 S, 320 S12	2310, 2333, 2337, 2343, 2353, 2377	304, 321, 316	S30400, S32100, S31600	M 3
2.3	EN 10 088-3 - 1.4460	1.4460, 1.4512, 1.4582	X8CrNiMo275, X4CrNiMoN6257	317 S16, 316 S16	2324, 2387, 2570	409, 430, 436	S40900, S4300, S43600	M 2
2.4	EN 1.4547	1.4547	X2CrNiMo20-18-6	HR41	2378	17-4PH	S31254	S 2
3.1	EN 1561 - EN-JL1030	0.6010, 0.6040	GG10, GG40	Grade150, Grade 400	0120, 0212, 0814	ASTM A48 class 20	F11401, F12801	K 1
3.2	EN 1561 - EN-JL1050	0.6025, 0.6040	GG25, GG40	Grade200, Grade 400	0125, 0130, 0140, 0217	ASTM A48 class 40, STM A48 class 60	F12801, F14101	K 2
3.3	EN 1561 - EN-JL2040	0.7040, 0.7070, 0.8145, 0.8045	GG40, GGG70, GTS45-06, GTW45-07	42012, P44007, 7002, 30g/72	0219, 0717, 0727, 0732, 0852	ASTM A220 grade 40010, ASTM A602 grade M4504	F22830, F20001	K 3
3.4	EN 1561 - EN-JL2050	0.7040, 0.7070, 0.8145, 0.8045	GG40, GGG70, GTS45-06, GTW45-07	42012, P44007, 7002, 30g/72	0221, 0223, 0737, 0854	ASTM A220 grade 90001, ASTM A602 grade M8501	F26230, 20005	K 4
4.1		3.7024LN	T199.8	TA1 to 9	T199.8	ASTM B265 grade 1	R50250	S 1
4.2		3.7164LN, 3.7119LN	TA16V4, TA165n2	TA10 to 14, TA17	TA16V4, TA165n2	AMS4928	R54790	S 2
4.3		3.7164LN, 3.7174LN, 3.7184LN	TA16V4, TA16V5Sn2, TA14MoSn2	TA10 to 13, TA28	TA16V5Sn2	AMS4928, AMS4971	R56400, R54790	S 3
5.1		2.4060, 2.4066	Nickel 200, 270, N199.6	NA 11, NA12	N1200, N1270	Nickel 200, Nickel 230	N02200, N02230	S 1
5.2		2.4630LN, 2.4602, 2.4650LN	Nimonic 75, Monel 400, Hastelloy C, Inconel 600	HR203, 3027-76		Nimonic 75, Monel 400, Hastelloy, Inconel 600	N06075, N10002, N04400, N06600	S 2
5.3		2.4668LN, 2.4631LN, 2.6554LN	Inconel 718, Nimonic 80A, Waspaloy	HR8, HR401, 601		Inconel 718, 625, Nimonic 80	N07718, N07080, N06625	S 3
6.1	EN 1652 - CW004A	2.0060, 2.0070	E-Cu57, SE-Cu	C101	5010	101	C10100, C1020	N 3
6.2	EN 1652 - CW612N	2.0360, 2.0360, 2.1030, 2.1080	CuZn39Pb2, CuZn40, CuSn8, CuSn6Zn	CZ120, CZ109, PB104	5168		C28000, C37710	N 4
6.3	EN 1652 - CW508L	2.0321, 2.0260	CuZn37, CuZn28	CZ108, CZ106	5150		C2600, C37720	N 3
6.4			Ampco 18, Ampco 25	AB1 type	5238, JIM7-20			N 4
7.1	EN 485-2 - EN AW-1070A	3.0255	Al99.5	LM0, 1 B (1050A)	4005	EC, 1060, 1100	A91060, A91100	N 1
7.2	EN 755-2 - EN AW-5005	3.1355, 3.3525	AlCuMg2, AlMg2Mn0.8	LM5, 10, 12, N4 (6251)	4106, 4212	380, 520.0, 520.2, 2024, 6061	A03800, A05200, A92024	N 1
7.3	EN 1706 - EN AC-42000	3.2162.05, 3.2341.01	GD-ALSi8Cu, G-ASi5Mg	LM2, 4, 16, 18, 21, 22, 24, 25, 26, 27, L109	4244	319.0, 333.0, 319.1, 356.0	A03190, A03330, C35600	N 1
7.4	SS-EN 1706 - EN AC-47000	3.2581.01	G-ALSiH8, G-ALSi12	LM6, 12, 13, 20, 28, 29, 30	4260, 4261, 4262	4032, 222.1, A332.0	A94032, A02220, A13320	N 2
8.1			Polystyrene, Nylon, PVC Cellulose, Acetate & Nitrate			Polystyrene, Nylon, PVC		O
8.2			Ebonite, Tufnol, Bakelite			Bakelite		O
8.3			Kevlar, Printed Circuit boards			Kevlar		O
9.1			Ferrocite, Ferrotitanit					H
10.1			Graphite					O

Таблица режимов резания

м/мин	5	8	10	15	20	25	30	40	50	60	70	80	90	100	110	150	
футов/мин	16	26	32	50	66	82	98	130	165	197	230	262	296	330	362	495	
Ø		об/мин															
мм	дюйм																
1,00		1592	2546	3183	4775	6366	7958	9549	12732	15916	19099	22282	25465	28648	31831	35014	47747
1,50		1061	1698	2122	3183	4244	5305	6366	8488	10610	12732	14854	16977	19099	21221	23343	31831
2,00		796	1273	1592	2387	3183	3979	4775	6366	7958	9549	11141	12732	14324	15916	17507	23873
2,50		637	1019	1273	1910	2546	3183	3820	5093	6366	7639	8913	10186	11459	12732	14006	19099
3,00		531	849	1061	1592	2122	2653	3183	4244	5305	6366	7427	8488	9549	10610	11671	15916
3,18	1/8	500	801	1001	1501	2002	2502	3003	4004	5005	6006	7007	8008	9009	10010	11011	15015
3,50		455	728	909	1364	1819	2274	2728	3638	4547	5457	6366	7276	8185	9095	10004	13642
4,00		398	637	796	1194	1592	1989	2387	3183	3979	4775	5570	6366	7162	7958	8754	11937
4,50		354	566	707	1061	1415	1768	2122	2829	3537	4244	4951	5659	6366	7074	7781	10610
4,76	3/16	334	535	669	1003	1337	1672	2006	2675	3344	4012	4681	5350	6018	6687	7356	10031
5,00		318	509	637	955	1273	1592	1910	2546	3183	3820	4456	5093	5730	6366	7003	9549
6,00		265	424	531	796	1061	1326	1592	2122	2653	3183	3714	4244	4775	5305	5836	7958
6,35	1/4	251	401	501	752	1003	1253	1504	2005	2506	3008	3509	4010	4511	5013	5514	7519
7,00		227	364	455	682	909	1137	1364	1819	2274	2728	3183	3638	4093	4547	5002	6821
7,94	5/16	200	321	401	601	802	1002	1203	1604	2004	2405	2806	3207	3608	4009	4410	6013
8,00		199	318	398	597	796	995	1194	1592	1989	2387	2785	3183	3581	3979	4377	5968
9,00		177	283	354	531	707	884	1061	1415	1768	2122	2476	2829	3183	3537	3890	5305
9,53	3/8	167	267	334	501	668	835	1002	1336	1670	2004	2338	2672	3006	3340	3674	5010
10,00		159	255	318	477	637	796	955	1273	1592	1910	2228	2546	2865	3183	3501	4775
11,11	7/16	143	229	287	430	573	716	860	1146	1433	1719	2006	2292	2579	2865	3152	4298
12,00		133	212	265	398	531	663	796	1061	1326	1592	1857	2122	2387	2653	2918	3979
12,70	1/2	125	201	251	376	501	627	752	1003	1253	1504	1754	2005	2256	2506	2757	3760
14,00		114	182	227	341	455	568	682	909	1137	1364	1592	1819	2046	2274	2501	3410
14,29	9/16	111	178	223	334	446	557	668	891	1114	1337	1559	1782	2005	2228	2450	3341
15,00		106	170	212	318	424	531	637	849	1061	1273	1485	1698	1910	2122	2334	3183
15,88	5/8	100	160	200	301	401	501	601	802	1002	1203	1403	1604	1804	2004	2205	3007
16,00		99	159	199	298	398	497	597	796	995	1194	1393	1592	1790	1989	2188	2984
17,46	11/16	91	146	182	273	365	456	547	729	912	1094	1276	1458	1641	1823	2005	2735
18,00		88	141	177	265	354	442	531	707	884	1061	1238	1415	1592	1768	1945	2653
19,05	3/4	84	134	167	251	334	418	501	668	835	1003	1170	1337	1504	1671	1838	2506
20,00		80	127	159	239	318	398	477	637	796	955	1114	1273	1432	1592	1751	2387
24,00		66	106	133	199	265	332	398	531	663	796	928	1061	1194	1326	1459	1989
25,00		64	102	127	191	255	318	382	509	637	764	891	1019	1146	1273	1401	1910
27,00		59	94	118	177	236	295	354	472	589	707	825	943	1061	1179	1297	1768
30,00		53	85	106	159	212	265	318	424	531	637	743	849	955	1061	1167	1592
32,00		50	80	99	149	199	249	298	398	497	597	696	796	895	995	1094	1492
36,00		44	71	88	133	177	221	265	354	442	531	619	707	796	884	973	1326
40,00		40	64	80	119	159	199	239	318	398	477	557	637	716	796	875	1194
50,00		32	51	64	95	127	159	191	255	318	382	446	509	573	637	700	955

HV	HRC	HB		
Vickers	Rockwell	Brinell	N/ mm ²	Tons/ sq. in.
940	68			
900	67			
864	66			
829	65			
800	64			
773	63			
745	62			
720	61			
698	60			
675	59			
655	58		2200	142
650		618	2180	141
640		608	2145	139
639	57	607	2140	138
630		599	2105	136
620		589	2070	134
615	56	584	2050	133
610		580	2030	131
600		570	1995	129
596	55	567	1980	128
590		561	1955	126
580		551	1920	124
578	54	549	1910	124
570		542	1880	122
560	53	532	1845	119
550		523	1810	117
544	52	517	1790	116
540		513	1775	115
530		504	1740	113
527	51	501	1730	112
520		494	1700	110
514	50	488	1680	109
510		485	1665	108
500		475	1630	105
497	49	472	1620	105
490		466	1595	103
484	48	460	1570	102
480		456	1555	101
473	47	449	1530	99
470		447	1520	98
460		437	1485	96
458	46	435	1480	96
450		428	1455	94
446	45	424	1440	93
440		418	1420	92

HV	HRC	HB		
Vickers	Rockwell	Brinell	N/ mm ²	Tons/ sq. in.
434	44	413	1400	91
423	43	402	1360	88
413	42	393	1330	86
403	41	383	1300	84
392	40	372	1260	82
382	39	363	1230	80
373	38	354	1200	78
364	37	346	1170	76
355	36	337	1140	74
350		333	1125	73
345	35	328	1110	72
340		323	1095	71
336	34	319	1080	70
330		314	1060	69
327	33	311	1050	68
320		304	1030	67
317	32	301	1020	66
310	31	295	995	64
302	30	287	970	63
300		285	965	62
295		280	950	61
293	29	278	940	61
290		276	930	60
287	28	273	920	60
285		271	915	59
280	27	266	900	58
275		261	880	57
272	26	258	870	56
270		257	865	56
268	25	255	860	56
265		252	850	55
260	24	247	835	54
255	23	242	820	53
250	22	238	800	52
245		233	785	51
243	21	231	780	50
240		228	770	50
235		223	755	49
230		219	740	48
225		214	720	47
220		209	705	46
215		204	690	45
210		199	675	44
205		195	660	43
200		190	640	41

Квалитет	Ø mm							
	> 1 ≤ 3	> 3 ≤ 6	> 6 ≤ 10	> 10 ≤ 18	> 18 ≤ 30	> 30 ≤ 50	> 50 ≤ 80	> 80 ≤ 120
	µm							
e8	-14 / -28	-20 / -38	-25 / -47	-32 / -59	-40 / -73	-50 / -89	-60 / -106	-72 / -126
f6	-6 / -12	-10 / -18	-13 / -22	-16 / -27	-20 / -33	-25 / -41	-30 / -49	-36 / -58
f7	-6 / -16	-10 / -22	-13 / -28	-16 / -34	-20 / -41	-25 / -50	-30 / -60	-36 / -71
h6	0 / -6	0 / -8	0 / -9	0 / -11	0 / -13	0 / -16	0 / -19	0 / -22
h7	0 / -10	0 / -12	0 / -15	0 / -18	0 / -21	0 / -25	0 / -30	0 / -35
h8	0 / -14	0 / -18	0 / -22	0 / -27	0 / -33	0 / -39	0 / -46	0 / -54
h9	0 / -25	0 / -30	0 / -36	0 / -43	0 / -52	0 / -62	0 / -74	0 / -87
h10	0 / -40	0 / -48	0 / -58	0 / -70	0 / -84	0 / -100	0 / -120	0 / -140
h11	0 / -60	0 / -75	0 / -90	0 / -110	0 / -130	0 / -160	0 / -190	0 / -220
h12	0 / -100	0 / -120	0 / -150	0 / -180	0 / -210	0 / -250	0 / -300	0 / -350
k10	+40 / 0	+48 / 0	+58 / 0	+70 / 0	+84 / 0	+100 / 0	+120 / 0	+140 / 0
k12	+100 / 0	+120 / 0	+150 / 0	+180 / 0	+210 / 0	+250 / 0	+300 / 0	+350 / 0
m7	+2 / +12	+4 / +16	+6 / +21	+7 / +25	+8 / +29	+9 / +34	+11 / +41	+13 / +48
js14	+/- 125	+/- 150	+/- 180	+/- 215	+/- 260	+/- 310	+/- 370	+/- 435
js16	+/- 300	+/- 375	+/- 450	+/- 550	+/- 650	+/- 800	+/- 950	+/- 1100
H7	+10 / 0	+12 / 0	+15 / 0	+18 / 0	+21 / 0	+25 / 0	+30 / 0	+35 / 0
H8	+14 / 0	+18 / 0	+22 / 0	+27 / 0	+33 / 0	+39 / 0	+46 / 0	+54 / 0
H9	+25 / 0	+30 / 0	+36 / 0	+43 / 0	+52 / 0	+62 / 0	+74 / 0	+87 / 0
H12	+100 / 0	+120 / 0	+150 / 0	+180 / 0	+210 / 0	+250 / 0	+300 / 0	+350 / 0
P9	-6 / -31	-12 / -42	-15 / -51	-18 / -61	-22 / -74	-26 / -86	-32 / -106	-37 / -124

1µm = 0.001 mm

СВЕРЛЕНИЕ

ОБЩИЕ УКАЗАНИЯ ПО СВЕРЛЕНИЮ

1. Выберите оптимальное сверло для выполняемой операции, учитывая характеристики обрабатываемого материала, станка и используемой СОЖ.
2. Недостаточная жесткость обрабатываемой детали и шпинделя станка могут привести к поломке сверла. Жесткость можно увеличить, используя сверла с наименьшей возможной длиной.
3. При сверлении важно правильное закрепление инструмента, сверло должно иметь минимальное радиальное биение и не перемещаться в патроне.
4. При сверлении некоторых материалов рекомендуется использовать смазочно-охлаждающие жидкости. При их применении убедитесь, что СОЖ подается в достаточном количестве, в том числе и к вершине сверла.
5. Удаление стружки необходимо для обеспечения надежности процесса сверления. Не допускайте забивания стружкой стружечных канавок сверла.
6. При переточке сверла необходимо следить за правильностью заточки геометрии вершины сверла и за полным удалением следов износа.

РАЗМЕР ОТВЕРСТИЯ

Точность обработанного отверстия возрастает с улучшением геометрии, вида инструментального материала и покрытия используемого сверла. Как правило, сверлом со стандартной геометрией можно получить отверстие с допуском по Н12. В благоприятных условиях твердосплавное сверло с оптимизированной заточкой позволяет получить отверстие с допуском по Н8. Для лучшего понимания ниже приведены различные типы сверл и точность отверстий, ими обработанных:

- Сверла общего применения из быстрорежущей стали – Н12
- Сверла с параболической канавкой для сверления глубоких отверстий из быстрорежущей стали / HSS-E – Н10
- С покрытием из твердого сплава с высокими характеристиками – Н8/Н9

МЕТОДИКА СВЕРЛЕНИЯ ГЛУБОКИХ ОТВЕРСТИЙ

При сверлении глубоких отверстий могут быть использованы различные методы. Ниже, на примере сверления отверстия глубиной 10xD, приведены четыре из них.

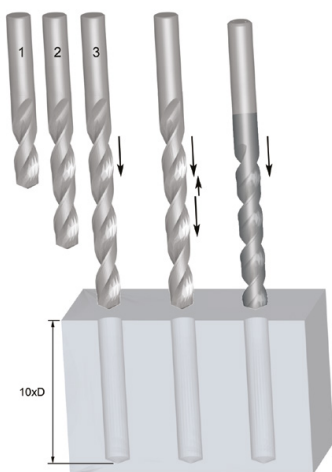

	Сверление набором сверл	Сверление набором сверл
Количество сверл	3 (2,5xD, 6xD, 10xD)	2 (2,5xD, 10xD)
Тип сверла	Стандартная геометрия, общего применения	Стандартная геометрия, общего применения
+ / -	Дорогой, Требующий значительных временных затрат	Более экономически эффективный, Быстрый

	Сверление с выводом	Сверление за один проход
Количество сверл	1 (10xD)	1 (10xD)
Тип сверла	Стандартная геометрия, общего применения	Сверла для специального применения
+ / -	Требующий значительных временных затрат	Экономически эффективный, Быстрый

ВОЗМОЖНЫЕ ТРУДНОСТИ ПРИ СВЕРЛЕНИИ И СПОСОБЫ ИХ УСТРАНЕНИЯ

ПРОБЛЕМА	ПРИЧИНА	СПОСОБ УСТРАНЕНИЯ
Сломанная или погнутая лапка сверла	Плохой контакт между хвостовиком сверла и патроном	Устранить загрязнения и повреждения на хвостовике сверла и в патроне
Трещина перемычки	Слишком большая подача	Снизить подачу до оптимального значения
	Недостаточный задний угол	Переточить сверло с соблюдением геометрии
	Слишком большая подточка перемычки	Переточить сверло с соблюдением геометрии
	Сильный удар по вершине сверла	Избегайте ударов по вершине сверла. Осторожно закрепляйте и извлекайте сверла с конусом Морзе из шпинделя
Изношены внешние углы сверла	Слишком большая скорость резания	Снизить скорость до оптимального значения – возможно увеличить подачу
Сколоты внешние углы сверла	Нежесткое закрепление заготовки	Жестче закрепить заготовку, оптимизировать перемещения сверла в заготовке
Выкрашивание режущих кромок	Слишком большой задний угол	Переточить сверло с соблюдением геометрии
Поломка ленточек	Закусывание ленточек	Применить сверление с выводом / сверление набором сверл
	Сверло проворачивается	Проверить закрепление сверла в патроне и в шпинделе
Спиральный след в отверстии	Недостаточная подача	Увеличить подачу
	Увод сверла	Использовать центровочное сверло перед сверлением
Диаметр отверстия выходит за пределы поля допуска	Неправильная геометрия вершины сверла	Проверить геометрию
	Плохой отвод стружки, пакетирование	Изменить скорость, подачу и глубину сверления для получения более управляемого отвода стружки

РАЗВЁРТЫВАНИЕ**ОБЩИЕ УКАЗАНИЯ ПО РАЗВЁРТЫВАНИЮ**

Для получения наилучших результатов при развёртывании очень важно заставить развёртку работать. Общей ошибкой является минимальный припуск при подготовке отверстия под развёртывание. При развёртывании отверстия с недостаточным припуском инструмент будет стирать его, но не резать, и как следствие, быстро изнашиваться теряя размер. Также важно не оставить слишком большой припуск под развёртывание. (См. “Припуск на обработку”, описанный ниже).

1. Выберите оптимальный инструмент и режимы резания для выполняемой операции. Убедитесь, что отверстия, подготовленные под развёртывание, имеют правильный диаметр.
2. Обрабатываемая деталь должна быть жестко закреплена, шпиндель станка не должен иметь биения.
3. Для закрепления развёртки с цилиндрическим хвостовиком необходимо использовать качественный патрон. Биение развёртки в патроне при автоматической подаче может привести к поломке инструмента.
4. Старайтесь применять инструмент на минимальном вылете от шпинделя станка.
5. Применение СОЖ увеличивает стойкость развёртки, при этом необходимо следить за поступлением СОЖ непосредственно к режущим кромкам инструмента. Использование СОЖ с концентрацией 40:1 дает хорошие результаты. При обработке чугуна можно применить охлаждение сжатым воздухом.
6. Не допускайте пакетирования стружки в стружечных канавках при развёртывании.
7. Перед переточкой развёртки необходимо проверить ее биение относительно центровых отверстий. В большинстве случаев переточке подлежит только заборная часть развёртки.
8. Сохраняйте развёртки острыми. Частая переточка экономически выгодна, т. к. переточке подлежит только заборная часть, а калибрующие ленточки не перетачиваются. Правильная переточка влияет на качество обработанных отверстий и стойкость инструмента.

ПРИПУСК НА ОБРАБОТКУ

Величина припуска, необходимого для развёртывания, зависит от обрабатываемого материала и качества подготовленного отверстия. Основные рекомендации по припуску на обработку приведены в следующих таблицах:

Диаметр развёртываемого отверстия (мм)	После сверления	После зенкерования	Диаметр развёртываемого отверстия (дюймы)	После сверления	После зенкерования
Менее 4	0.1	0.1	Менее 3/16	0.004	0.004
От 4 до 11	0.2	0.15	От 3/16 до 1/2	0.008	0.006
От 11 до 39	0.3	0.2	От 1/2 до 1 1/2	0.010	0.008
От 39 до 50	0.4	0.3	От 1 1/2 до 2	0.016	0.010

ПРЕДЕЛЫ ДОПУСКА



1. ДОПУСК ДИАМЕТРА КАЛИБРУЮЩЕЙ ЧАСТИ РАЗВЕРТОК

Диаметр (d_1) измеряется на круглой части сразу за скосом или заборным конусом. Допуск соответствует DIN 1420 и предназначен для получения отверстий H7.

ДОПУСК КАЛИБРУЮЩЕЙ ЧАСТИ			
Диаметр (мм)		Предел допуска (мм)	
Свыше	До и включая	Высокий +	Низкий +
	3	0.008	0.004
3	6	0.010	0.005
6	10	0.012	0.006
10	18	0.015	0.008

ДОПУСК КАЛИБРУЮЩЕЙ ЧАСТИ			
Диаметр (мм)		Предел допуска (мм)	
Свыше	До и включая	Высокий +	Низкий +
	30	0.017	0.009
30	50	0.021	0.012
50	80	0.025	0.014

2. ДЛЯ ОТВЕРСТИЯ H7

Точные отверстия, как правило, выполняются с допуском по H7 (см. таблицу ниже). Для отверстий с другими допусками границы поля допуска можно рассчитать, используя схему расчета и таблицу, приведенные в п.3.

ДОПУСК ОТВЕРСТИЯ			
Диаметр (мм)		Предел допуска (мм)	
Свыше	До и включая	Высокий +	Низкий +
	3	0.010	0
3	6	0.012	0
6	10	0.015	0
10	18	0.018	0

ДОПУСК ОТВЕРСТИЯ			
Диаметр (мм)		Предел допуска (мм)	
Свыше	До и включая	Высокий +	Низкий +
	30	0.021	0
30	50	0.025	0
50	80	0.030	0

3. Когда необходимо определить размеры развертки для обработки отверстия с определенным допуском, к примеру, D8, можно использовать следующие рекомендации.

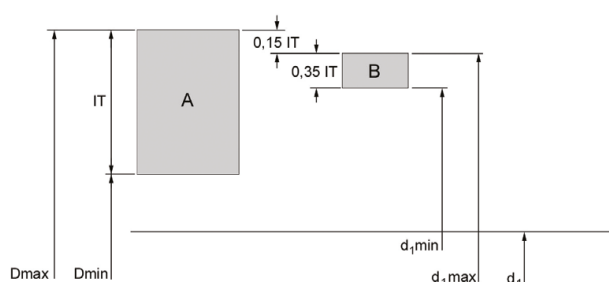

A = Допуск отверстия
 B = Допуск развертки
 IT = Поле допуска
 Dmax = Макс. диаметр отверстия
 Dmin = Мин. диаметр отверстия
 d_1 = Номинальный диаметр развёртки
 $d_{1,max}$ = Макс. диаметр развёртки
 $d_{1,min}$ = Мин. диаметр развёртки

Поле допуска (микроны)	Поле допуска на диаметр (мм)							
	от 1 до включ. 3	от 3 до включ. 6	от 6 до включ. 10	от 10 до включ. 18	от 18 до включ. 30	от 30 до включ. 50	от 50 до включ. 80	от 80 до включ. 120
IT5	4	5	6	8	9	11	13	15
IT6	6	8	9	11	13	16	19	22
IT7	10	12	15	18	21	25	30	35
IT8	14	18	22	27	33	39	46	54
IT9	25	30	36	43	52	62	74	87
IT10	40	48	58	70	84	100	120	140
IT11	60	75	90	110	130	160	190	220
IT12	100	120	150	180	210	250	300	350

например, отверстие в 10 мм с допуском D8, макс. диам. отверстия = 10,062, мин. диам. отверстия = 10,040, поле допуска на диаметр (IT8) = 0,022

Для расчета макс. диаметра развертки из макс. диаметра отверстия: вычитаем 0,15 от поля допуска для отверстия, округленных до 0,001 мм в большую сторону. 0,15 x поле допуска отверстия (IT8) = 0,0033, округляем до 0,004 мм

Для расчета мин. диаметра развертки из макс. диаметра отверстия: вычитаем 0,35 от поля допуска для отверстия, округленных до 0,001 мм в большую сторону. 0,35 x поле допуска отверстия (IT8) = 0,0077, округляем до 0,008 мм

Макс. диаметр развертки = 10,062 – 0,004 = 10,058

Мин. диаметр развертки = 10,058 – 0,008 = 10,050

ВОЗМОЖНЫЕ ТРУДНОСТИ ПРИ РАЗВЕРТЫВАНИИ И СПОСОБЫ ИХ УСТРАНЕНИЯ

ПРОБЛЕМА	ПРИЧИНА	СПОСОБ УСТРАНЕНИЯ
Сломанная или погнутая лапка развёртки	Плохой контакт между хвостовиком и патроном	Устранить загрязнения и повреждения на хвостовике развёртки и в патроне
Быстрый износ инструмента	Слишком маленький припуск на обработку	Увеличить припуск на обработку
Выход диаметра отверстия за пределы допуска	Увеличенная высота ленточки	Переточить до требуемого диаметра
	Смещение в шпинделе станка	Отремонтировать шпиндель станка
	Дефект патрона	Заменить патрон
	Хвостовик инструмента поврежден	Замените инструмент или перешлифуйте хвостовик
	Овальность инструмента	Заменить или переточить инструмент
	Несимметричное расположение заборной части	Переточить до требуемого диаметра
	Слишком высокая скорость	Выбрать режимы резания согласно рекомендациям каталога
Отверстие меньше требуемого размера	Слишком маленький припуск на обработку	Увеличить припуск на обработку
	Чрезмерное выделение тепла при развёртывании. Отверстие расширяется при обработке и затем усаживается	Увеличить подачу СОЖ
	Инструмент изношен	Переточить до требуемого диаметра
	Недостаточные подача или скорость резания	Выбрать режимы резания согласно рекомендациям каталога
	Просверленное отверстие имеет слишком маленький диаметр	Уменьшить припуск на обработку
	Отверстие имеет форму овала или конуса	Смещение в шпинделе станка
	Несоосность инструмента с отверстием	Использовать регулируемую развёртку
	Несимметричное расположение заборной части	Переточить до требуемого диаметра
	Плохое качество обработанной поверхности	Слишком большой припуск на обработку
Инструмент изношен		Переточить до требуемого диаметра
Слишком маленький передний угол		Переточить до требуемого диаметра
Плохое качество СОЖ или низкая концентрация		Увеличить концентрацию
Слишком маленькая подача или скорость резания		Выбрать режимы резания согласно рекомендациям каталога
Слишком высокая скорость резания		Выбрать режимы резания согласно рекомендациям каталога
Инструмент прихватывается и ломается	Инструмент изношен	Переточить до требуемого диаметра
	Обратная конусность инструмента слишком мала	Проверить и заменить инструмент
	Ширина ленточки слишком большая	Проверить и заменить инструмент
	Обрабатываемый материал склонен к усадке	Использовать регулируемую развёртку для компенсации усадки
	Слишком большой припуск на обработку	Уменьшить припуск на обработку
	Неоднородный материал с твердыми включениями	Использовать твердосплавную развёртку

ФРЕЗЕРОВАНИЕ РЕЗЬБЫ

ОБЩИЕ СВЕДЕНИЯ О ФРЕЗЕРОВАНИИ РЕЗЬБЫ

Фрезерование резьбы — это процесс нарезания резьбы путем винтовой интерполяции фрезы с определенной геометрией резьбы вокруг ее периферии.

Чтобы использовать резьбовую фрезу, необходимо иметь станок с ЧПУ, который может совершать движения по винтовой интерполяции.

Большинство современных станков с ЧПУ имеет циклы обработки для фрезерования резьбы.

Для получения информации ознакомьтесь с руководством или обратитесь к поставщику станка.

ОСОБЕННОСТИ И ПРЕИМУЩЕСТВА

Фрезерование резьбы способствует увеличению надежности и срока службы инструмента.

При использовании резьбовых фрез образуется мелкая стружка.

Корректировка допуска может быть выполнена при условии использования точных координат.

Можно нарезать резьбу на всю глубину отверстия.

Можно обрабатывать самые разнообразные материалы.

Кроме того, одна и та же фреза может быть использована для нарезания резьбы разного размера, при условии, что шаг остается неизменным.

Одним и тем же инструментом можно нарезать как правую, так и левую резьбу

Некоторые резьбовые фрезы можно также использовать для обработки заходных фасок (J200, J205, J260)

ВЫБОР ИНСТРУМЕНТА

Резьбовые фрезы имеют код товара, формируемый на основе типа, диаметра (d_1) и шага (P).

Код товара — это номер, используемый при заказе инструмента.

Постоянно обращайтесь к каталогу для уверенности в правильном использовании размеров резьбы.

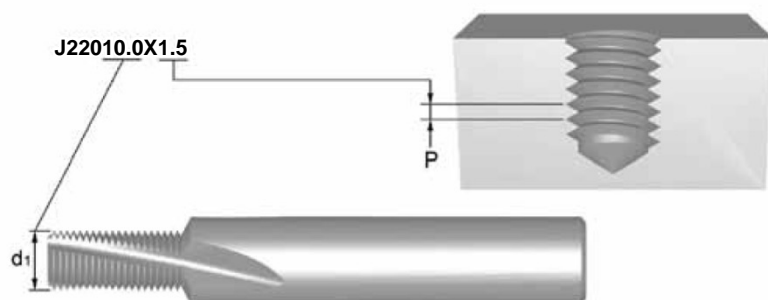

Данная резьбовая фреза может использоваться для нарезания резьб $\geq M12 \times 1,5$ ($M14 \times 1,5$, $M18 \times 1,5$ и т. д.).

ПРОГРАММИРОВАНИЕ С ИСПОЛЬЗОВАНИЕМ ИНДИВИДУАЛЬНОГО ЗНАЧЕНИЯ КОРРЕКЦИИ НА РАДИУС (RPRG)

Для облегчения регулировки допуска резьбы всегда производите программирование с поправкой на радиус.

Значение Rprg является начальным значением для новой резьбы; это значение можно найти на хвостовике фрезы. Его необходимо внести в список коррекций на инструмент в памяти.

Значение Rprg связано с теоретической нулевой линией резьбы. Это означает, что при программировании с использованием значения Rprg резьба никогда не выйдет за пределы допуска, она будет иметь требуемые параметры.

Таким образом, при внесении небольшого изменения в координаты программы можно получить резьбу необходимого размера.

РЕКОМЕНДАЦИИ

Всегда используйте надлежащие данные для расчета режимов резания (см. таблицу данных для расчета режимов резания).

Используйте сверло рекомендуемого размера с учетом диаметра резьбы, как и при работе с обычными метчиками.

Для облегчения регулировки допуска резьбы всегда начинайте обработку со значения Rprg, обозначенного на хвостовике резьбовой фрезы.

Используйте калибр для проверки допуска на первой резьбе, чтобы определить, не требуется ли корректировка радиуса. Радиус можно корректировать 2 или 3 раза, прежде чем произойдет износ резьбы.

При сухой обработке рекомендуется использовать сжатый воздух, который поможет удалить стружку.

При нарезании резьбы в труднообрабатываемых материалах рекомендуется делать 2 или 3 прохода.

НАРЕЗАНИЕ РЕЗЬБЫ

ОБЩИЕ УКАЗАНИЯ ПО НАРЕЗАНИЮ РЕЗЬБЫ МЕТЧИКАМИ

Результат любой операции по нарезанию резьбы зависит от ряда факторов, каждый из которых, в конечном счете, влияет на качество готовой детали.

1. Выберите правильную конструкцию метчика для данного обрабатываемого материала и типа отверстия, т. е. сквозного или глухого, из таблицы группы обрабатываемых материалов.
2. Убедитесь, что деталь надежно закреплена – перемещения в процессе обработки могут привести к поломке метчика или плохому качеству резьбы.
3. Выберите правильный размер сверла с соответствующей страницы каталога. Старайтесь не допускать упрочнения материала заготовки.
4. Выберите правильное значение скорости резания, как показано в каталоге.
5. Используйте СОЖ, соответствующую выполняемой операции.
6. При нарезании резьбы на станках с ЧПУ проверьте значение подачи, указанное в программе. При использовании резьбонарезного патрона значение подачи на оборот должно составлять от 95 до 97 % от шага, чтобы позволить метчику самому формировать нужный профиль резьбы.
7. По возможности используйте качественные патроны с компенсацией для ограничения крутящего момента, которые гарантируют осевое перемещение метчика и устанавливают его прямо в отверстии. Также это предохранит метчик от поломки при случайном столкновении с дном отверстия.
8. Убедитесь в том, что метчик плавно входит в отверстие, прерывистая подача может привести к искажению профиля резьбы.

ТАБЛИЦА СООТВЕТСТВИЯ ДОПУСКОВ МЕТЧИКОВ И ВНУТРЕННИХ РЕЗЬБ

ПОЛЕ ДОПУСКА, МЕТЧИК			ПОЛЕ ДОПУСКА, ВНУТРЕННЯЯ РЕЗЬБА (ГАЙКА)					ПРИМЕНЕНИЕ
ISO	DIN	ANSI BS						
ISO 1	4 H	3 B	4 H	5 H				Соединение с натягом
ISO 2	6 H	2 B	4 G	5 G	6 H			Соединение по переходной посадке
ISO 3	6 G	1 B			6 G	7 H	8 H	Соединение с зазором
-	7 G	-				7 G	8 G	Прослабленная резьба под нанесение покрытия

ВОЗМОЖНЫЕ ТРУДНОСТИ ПРИ РАБОТЕ МЕТЧИКАМИ И СПОСОБЫ ИХ УСТРАНЕНИЯ

ПРОБЛЕМА	ПРИЧИНА	СПОСОБ УСТРАНЕНИЯ
Увеличенный размер резьбового отверстия	Неправильный допуск	Выбрать метчик с меньшим полем допуска
	Неправильное значение осевой подачи	Снизить подачу на 5-10% или увеличить жесткость пружины в резьбовом патроне
	Для данной операции неправильно выбран тип метчика	Использовать метчик со спиральной подточкой для сквозных отверстий или со спиральной канавкой для глухих отверстий. Использовать инструмент с покрытием для предотвращения наростообразования
	Ось метчика не совпадает с осью отверстия	Проверить резьбовой патрон и позиционирование относительно отверстия
	Недостаточный подвод СОЖ	Улучшить смазочно-охлаждающую среду для предотвращения наростообразования. См. раздел СОЖ в “Техническом Руководстве”
	Недостаточная скорость резания	Следуйте рекомендациям в каталоге / Product Selector
Уменьшенный размер резьбового отверстия	Для данной операции неправильно выбран тип метчика	Использовать метчик со спиральной подточкой для сквозных отверстий или со спиральной канавкой для глухих отверстий. Использовать инструмент с покрытием для предотвращения наростообразования. Использовать метчик с большим передним углом
	Неправильный допуск	Выбрать метчик с меньшим полем допуска, особенно для материалов, не склонных к изменению размеров, таких как сталь и чугун
	Неправильный или недостаточный подвод СОЖ	Улучшить смазочно-охлаждающую среду для предотвращения пакетирования стружки в отверстии. См. раздел СОЖ в “Техническом Руководстве”
	Диаметр отверстия под резьбу слишком мал	Увеличить диаметр сверла до Максимального значения. Проверьте рекомендуемый диаметр сверления под резьбу
	Материал сужается после нарезания резьбы	См. рекомендации в каталоге Dormer или Product Selector для правильного выбора инструмента
Выкрашивания	Для данной операции неправильно выбран тип метчика	Выбрать метчик с меньшим передним углом. Использовать метчик с более длинной заборной частью или со спиральной подточкой для сквозных отверстий, или со спиральной канавкой для глухих отверстий для предотвращения пакетирования стружки
	Неправильный или недостаточный подвод СОЖ	Улучшить смазочно-охлаждающую среду для предотвращения наростообразования. См. раздел СОЖ в “Техническом Руководстве”
	Метчик ударяется о дно отверстия	Увеличить глубину сверления или уменьшить глубину резбонарезания
	Наклеп на обработанной поверхности	Уменьшить скорость, использовать инструмент с покрытием, улучшить смазочно-охлаждающую среду. См. раздел “обработка нержавеющей сталей” в “Техническом Руководстве”
	Заклинивание стружки при вывинчивании на обратном ходу	Избегать внезапного вывода метчика на обратном ходу
	Заборная часть бьет при входе в отверстие	Проверить соосность отверстия и метчика, устранить несоосность
	Диаметр отверстия под резьбу слишком мал	Увеличить диаметр сверла до максимального значения. Проверьте рекомендуемый диаметр сверления под резьбу

ВОЗМОЖНЫЕ ТРУДНОСТИ ПРИ РАБОТЕ МЕТЧИКАМИ И СПОСОБЫ ИХ УСТРАНЕНИЯ

ПРОБЛЕМА	ПРИЧИНА	СПОСОБ УСТРАНЕНИЯ
Поломка	Метчик изношен	Использовать новый метчик или переточить изношенный
	Недостаточный подвод СОЖ	Улучшить смазочно-охлаждающую среду для предотвращения наростообразования и пакетирования стружки
	Метчик ударяется о дно отверстия	Увеличить глубину сверления или уменьшить глубину резьбонарезания
	Слишком высокая скорость резания	Снизить скорость резания. Следовать рекомендациям в каталоге/Product Selector
	Наклеп на обработанной поверхности	Уменьшить скорость, использовать инструмент с покрытием, улучшить смазочно-охлаждающую среду. См. раздел "обработка нержавеющей сталей" в "Техническом Руководстве"
	Диаметр отверстия под резьбу слишком мал	Увеличить диаметр сверла до максимального значения. См. таблицы с рекомендациями
	Слишком высокий момент при нарезании резьбы	Использовать резьбовой патрон с предохранительной муфтой
	Материал сужается после нарезания резьбы	См. рекомендации в каталоге Dormer или Product Selector для правильного выбора инструмента
Быстрое изнашивание метчика	Для данной операции неправильно выбран тип метчика	Использовать метчик с меньшим передним углом и/или большим затылованием и/или более длинной заборной частью. Использовать инструмент с покрытием
	Недостаточный подвод СОЖ	Улучшить смазочно-охлаждающую среду для предотвращения наростообразования и термических напряжений на режущей кромке.
	Слишком высокая скорость резания	Уменьшить скорость. Следуйте рекомендациям каталога Dormer или Product Selector
Образование нароста	Для данной операции неправильно выбран тип метчика	Использовать метчик с меньшим передним углом и/или большим затылованием
	Недостаточный подвод СОЖ	Улучшить смазочно-охлаждающую среду для предотвращения наростообразования
	Применение покрытий невозможно	Используйте метчик с рекомендованным типом поверхностной обработки
	Слишком низкая скорость резания	Следуйте рекомендациям каталога Dormer или Product Selector

Фрезерование

ОБЩИЕ УКАЗАНИЯ ПО ФРЕЗЕРОВАНИЮ

Фрезерование - процесс получения обработанной поверхности постепенным удалением определенного количества материала, называемого припуском, при помощи относительно медленного перемещения (подачи) фрезы, вращающейся с относительно высокой скоростью.

Отличительной чертой фрезерования является удаление каждым режущим зубом части припуска в форме мелкосегментной стружки.

ТИПЫ ФРЕЗЕРНОГО ИНСТРУМЕНТА

Три основных типа показаны ниже: (А) обработка плоскостей цилиндрической частью фрезы, (В) обработка плоскостей торцевой частью фрезы и (С) фрезерование уступов и пазов.

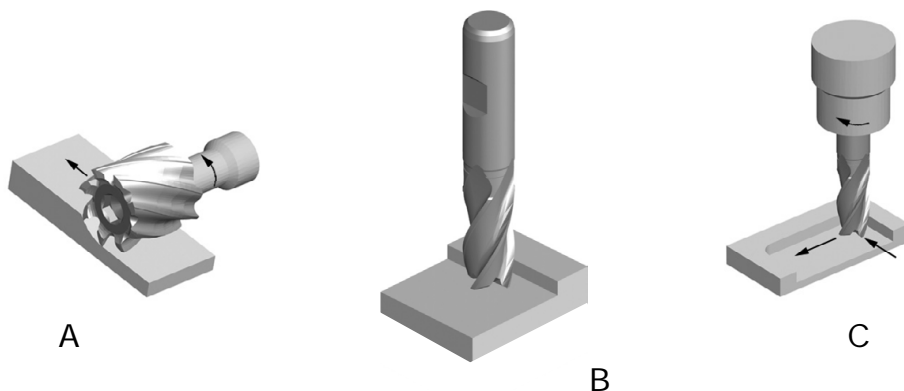

При цилиндрическом фрезеровании ось вращения фрезы параллельна обрабатываемой поверхности. Цилиндрическая фреза имеет несколько режущих зубьев, расположенных на поверхности цилиндра, каждый из которых последовательно срезает с заготовки слой металла.

Фрезы для торцевого фрезерования могут иметь прямые или спиральные режущие зубья, работающие в перпендикулярном или периферийном направлении.

При торцевом фрезеровании инструмент закрепляется в шпинделе станка так, чтобы ось вращения была перпендикулярна обрабатываемой поверхности. Обработка поверхности достигается за счет действия режущих кромок, расположенных на торце и периферии фрезы. При фрезеровании концевыми фрезами инструмент вращается, как правило, перпендикулярно к обработанной поверхности. Концевые фрезы могут быть наклонены для обработки конических поверхностей. Режущие кромки расположены на торце и периферии инструмента.

ОБЛАСТЬ ПРИМЕНЕНИЯ

Скорость съема материала и область применения фрезы сильно связаны между собой. Для каждой из областей применения мы имеем различные скорости съема материала, возрастающие с увеличением ширины фрезерования. В последнем каталоге Dormer различные области применения обозначаются простыми пиктограммами.

Фрезерование стенок	Торцевое фрезерование	Фрезерование пазов	Плунжерное фрезерование	Фрезерование с врезанием под углом
Ширина фрезерования должна быть не более 0.25 диаметра концевой фрезы.	Ширина фрезерования должна быть не более 0.9 диаметра концевой фрезы, глубина резания не более 0.1 диаметра.	Фрезерование пазов. Ширина фрезерования равна диаметру фрезы.	Засверливание возможно только фрезами с перекрытием режущих кромок на торце. При засверливании значение подачи должно быть равно половине рекомендуемого значения.	Врезание в материал заготовки происходит под углом (с подачей по двум координатам).

ВОЗМОЖНЫЕ ТРУДНОСТИ ПРИ ФРЕЗЕРОВАНИИ И СПОСОБЫ ИХ УСТРАНЕНИЯ

ПРОБЛЕМА	ПРИЧИНА	СПОСОБ УСТРАНЕНИЯ
Поломка	Слишком большая величина припуска, снимаемого за проход	Уменьшить значение подачи на зуб
	Слишком большая подача	Снизить подачу
Износ	Глубина резания или общая длина фрезы слишком велика	Выбрать инструмент с меньшей длиной/ закрепить инструмент ближе к зоне обработки
	Обрабатываемый материал имеет высокую твердость	Выбрать из каталога или Product Selector инструмент из соответствующего материала и с необходимым покрытием
	Неправильно выбраны значения подачи и скорости	См. рекомендуемые режимы резания в каталоге или Product Selector
	Плохая эвакуация стружки	Изменить место подвода СОЖ
	Встречное фрезерование	Попутное фрезерование
	Неправильно выбран угол наклона винтовой канавки	См. рекомендации по выбору инструмента в каталоге или Product Selector
Выкрашивание	Слишком высокая подача	Снизить подачу
	Вибрации	Снизить частоту вращения
	Низкая скорость резания	Увеличить частоту вращения
	Встречное фрезерование	Попутное фрезерование
	Жесткость инструмента	Выбрать инструмент с меньшей длиной/утопить хвостовик дальше в патрон
	Жесткость заготовки	Закрепить заготовку надежнее
Низкая стойкость	Слишком прочный обрабатываемый материал	См. рекомендации по выбору инструмента в каталоге или Product Selector
	Неправильно выбран передний угол и величина затылования	Выбрать инструмент с правильным передним углом
	Трение инструмент/заготовка	Использовать фрезу с покрытием
Плохое качество обработанной поверхности	Слишком высокая подача	Снизить величину подачи до рекомендуемых значений
	Слишком низкая скорость резания	Увеличить скорость
	Забивание стружкой	Уменьшить припуск, срезаемый за проход
	Износ инструмента	Заменить или переточить инструмент
	Наростообразование	Использовать фрезу с большим углом наклона канавок
	Приваривание стружки	Увеличить количество подаваемой СОЖ

ПРОБЛЕМА	ПРИЧИНА	СПОСОБ УСТРАНЕНИЯ
Неточность детали	Отжатие инструмента	Выбрать инструмент с меньшей длиной/утопить хвостовик дальше в патрон
	Недостаточное количество режущих зубьев	Выбрать инструмент с большим числом зубьев
	Износ или биение патрона	Заменить или отремонтировать патрон
	Недостаточная жесткость патрона	Заменить более коротким/жестким патроном
	Недостаточная жесткость шпинделя станка	Использовать станок с большим шпинделем
Вибрации	Слишком высокие величины скорости и подачи	Выбрать инструмент с меньшей длиной/закрепить инструмент ближе к зоне обработки
	Глубина резания или общая длина фрезы слишком велика	Выбрать инструмент с меньшей длиной/закрепить инструмент ближе к зоне обработки
	Слишком большая глубина резания	Уменьшить глубину резания
	Недостаточная жесткость станка и патрона	Проверить патрон и при необходимости заменить

ТВЕРДОСПЛАВНЫЕ БОРФРЕЗЫ (НА ОСНОВЕ КАРБИДА ВОЛЬФРАМА)

ОБЩИЕ СВЕДЕНИЯ О ТВЕРДОСПЛАВНЫХ БОРФРЕЗАХ

Твердосплавные борфрезы на основе карбида вольфрама широко используются для подготовки и отделки компонентов из широкого спектра материалов.

Обычно они используются в ручном режиме и устанавливаются на пневматических шлифовальных машинках.

ОСОБЕННОСТИ И ПРЕИМУЩЕСТВА

Упрочненные и закаленные стальные хвостовики увеличивают жесткость и уменьшают риск искривления и вибрации.

Точно выполненные хвостовики способствуют оптимальному удержанию и уменьшают вероятность вращения.

Использование специальных тупоугольных элементов позволяет предотвращать отказы в результате перегрева и также обеспечивает повышенную прочность, что помогает выдерживать давление и ударное воздействие.

Универсальная геометрия с двойной насечкой подходит для широкого спектра материалов и применений. Также возможно использование специальных геометрий, подходящих для стали (ST), нержавеющей стали (VA), алюминия (AL) и стекловолокна (GRP).

Возможно использование покрытия TiAlN, позволяющего увеличить срок службы инструмента при обработке абразивных материалов.

Борфрезы с закругленным концом являются фрезами с винтовой геометрией.

Это обеспечивает поддержание активной геометрии по направлению к центру борфрезы, что улучшает режущее действие и уменьшает вероятность образования стружки и засорения.

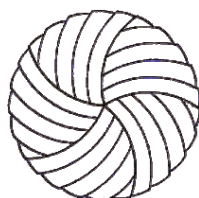

С винтовой геометрией

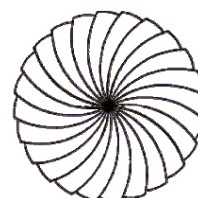

Обычные

БЕЗОПАСНОСТЬ ПРЕЖДЕ ВСЕГО

Высокоскоростные вращающиеся инструменты представляют собой опасность и могут быть опасны при использовании ненадлежащим образом.

Всегда отключайте шлифовальную машинку от линии подачи воздуха, прежде чем пытаться заменить борфрезы.

Проверьте состояние шлифовальной машинки и по возможности используйте ее вариант с меньшим уровнем вибрации.

Всегда используйте соответствующее защитное оборудование и проследите за тем, чтобы все, кто работает поблизости, также были защищены.



Средства индивидуальной защиты нужно использовать всегда.

РЕКОМЕНДАЦИИ

Всегда используйте подходящую шлифовальную машинку с номинальной скоростью вращения.

Важное значение имеет регулярное техническое обслуживание шлифовальных машинок, необходимо следить, чтобы они были смазаны, а подшипники не были изношенными.

При замене борфрезы всегда чистите зажимную гайку, патрон и внутренний конус шлифовальной машинки.

Старайтесь избегать механического воздействия на борфрезы и сильных ударов.

Старайтесь избегать резкой тепловой нагрузки на борфрезу, не допуская ее перегрева.

Не вводите борфрезу слишком глубоко в материал заготовки и не допускайте ее заклинивания в углах и каналах.

Устранение неисправностей при ИСПОЛЬЗОВАНИИ БОРФРЕЗ

ПРОБЛЕМА	ПРИЧИНА
Скалывание зубьев борфрезы	Использование при слишком низком числе оборотов, может привести к рывкам при работе борфрезы Биение (износ шпинделя, патрона или подшипников)
	Погружение борфрезы в материал и заклинивание
Забивание канавок для стружки борфрезы	Слишком большая длина канавки или общая длина
	Неверный выбор геометрии для материала заготовки
Преждевременный износ	Использование при слишком большом числе оборотов без учета размера борфрезы и материала заготовки Биение (износ шпинделя, патрона или подшипников)
	Использование при слишком большом числе оборотов, вызвавшее перегрев
Отсоединение головки от хвостовика	Использование при слишком большом числе оборотов, вызвавшее перегрев
	Использование в течение длительного периода времени, вызвавшее перегрев

Polski		Twardość	Wytrzymałość na rozciąganie	ISO
Grupy materiałów obrabianych (AMG)		HB	N/mm ²	
1. Stal	1.1 magnetyczna miękka	< 120	< 400	P 1
	1.2 konstrukcyjna do nawęglania	< 200	< 700	P 1
	1.3 węglowa	< 250	< 850	P 2
	1.4 stopowa	< 250	< 850	P 3
	1.5 stopowa-hartowana i odpuszczana	> 250 < 350	> 850 < 1200	P 4
	1.6 stopowa-hartowana i odpuszczana	> 350	> 1200 < 1620	H 1
	1.7 stopowa-hartowana	49-55HRC	> 1620	H 3
	1.8 stopowa-hartowana	55-63HRC	> 1980	H 4
2. Stal nierdzewna	2.1 automatowa	< 250	< 850	M 1
	2.2 austenityczna	< 320	< 1100	M 3
	2.3 ferrytyczna+austenityczna	< 300	< 1000	M 2
	2.4 Utwardzane wydzieleniowo	>320 <410	>1100 <1400	S 2
3. Żeliwo	3.1 szare	< 150	> 500	K 1
	3.2 szare	> 150 <300	> 500 < 1000	K 2
	3.3 sferoidalne ciągliwe	< 200	< 700	K 3
	3.4 sferoidalne ciągliwe	> 200 < 300	> 700 < 1000	K 4
4. Tytan	4.1 niestopowy	< 200	< 700	S 1
	4.2 stopy tytanu	< 270	< 900	S 2
	4.3 stopy tytanu	> 270 < 350	> 900 ≤ 1250	S 3
5. Nikiel	5.1 niestopowy	< 150	< 500	S 1
	5.2 stopy niklu	< 270	> 900	S 2
	5.3 stopy niklu	> 270 < 350	> 900 < 1200	S 3
6. Miedź	6.1 niestopowa	< 100	< 350	N 3
	6.2 Mosiądz-β, brąz	< 200	< 700	N 4
	6.3 Mosiądz CuZn	< 200	< 700	N 3
	6.4 Brąz o wysokiej wytrzymałości	< 470	< 1500	N 4
7. Aluminium Magnez	7.1 Al, Mg, niestopowe	< 100	< 350	N 1
	7.2 Al, Stopowe, Si<0,5%	< 150	< 500	N 1
	7.3 Al, Stopowe, Si>0,5%<10%	< 120	< 400	N 1
	7.4 Al, Stopowe, Si> 10%	< 120	< 400	N 2
8. Tworzywa sztuczne	8.1 Tworzywa termoplastyczne	---	---	O
	8.2 Tworzywa termoutwardzalne	---	---	O
	8.3 Zbrojone tworzywa sztuczne	---	---	O
9. Materiały twarde	9.1 Cermetale	< 550	< 1700	H
10. Grafit	10.1 Grafit standartowy	---	< 100	O

PRZYKŁADY NORM - KLASYFIKACJA
WG. ISO I AMG

AMG	EN	W.N.	DIN	BS	SS	USA	UNS	ISO
1.1		1.1015, 1.1013	Rte60, Rte100	230M07, 050A12	1160	Leadeds Steels	G12120	P1
1.2	EN 10 025 - S235JRG2	1.1012, 1.1053, 1.7131	S137-2, 16MnCr5, S150-2	060A35, 080M40, 4360-50B	1312, 1412, 1914	135, 30	G10100	P1
1.3	EN 10 025 - E295	1.1191, 1.0601	CK45, C60	080M46, 080A62	1550, 2142, 2172	1024, 1060, 1061	G10600	P2
1.4	EN 10 083-1 - 42 CrMo 4 - EN 10 270-2	1.7225, 1.3505, 1.6582, 1.3247	42CrMo4, 100Cr6, 34CrNiMo6, S2-10-1-8	708M40/42, 817M40, 554A99, BM2, BT42	1672-04, 2090, 2244-02, 2541-02	4140, A2, 4340, M42, M2	G41270, G41470, T30102, T11342	P3
1.5	EN ISO 4957 - HS6-5-2 - EN ISO 4957 - HS6-5-2-5	1.2510, 1.2713, 1.3247, 1.2080	100MnCrW12, 55NiCrMoV6, X210Cr12, S2-10-1-8	B01, BM2, BT42, 826 M40, 830M81	2244-04, 2541-03, 2550, 2722, 2723	01, L6, M42, D3, A2, M2, 4140, 8630	G86300, T30102 T11302, T30403, T11342	P4
1.6	EN ISO 4957 - HS2-9-1-8	1.2510, 1.2713, 1.3247, 1.2080	100MnCrW12, X210Cr12, S2-10-1-8	801, 826 M40, 830M81	2244-05, 2541-05, , HARDOX 400	01, L6, M42, D3, 4140, 8130	T30403, G41400, J14047	H1
1.7	EN ISO 4957 - HS2-9-1-8	1.2510	100MnCrW4	BO1, BD3, BH13	HARDOX 500			H3
1.8	EN ISO 4957 - X40CrMoV5-1	1.3343, 1.2344	S6-5-2, GX40CrMoV5-1	BM2, BH13	2242 HARDOX 600			H4
2.1	EN 10 088-3 - X14CrMoS17	1.4305, 1.4104	X10CrNiS189, X12CrMoS17	303 S21, 416 S37	2301, 2312, 2314, 2346, 2380	303, 416, 430F	S30300, S41600, S43020	M1
2.2	EN 10 088-2,0 - 3 - 1.4301+AT	1.4301, 1.4541, 1.4571	X5CrNi189, X10CrNiMoTi1810	304 S15, 321 S17, 316 S, 320 S12	2310, 2333, 2337, 2343, 2353, 2377	304, 321, 316	S30400, S32100, S31600	M3
2.3	EN 10 088-3 - 1.4460	1.4460, 1.4512, 1.4582	XBCrNiMo275, X4CrNiMoN6257	317 S16, 316 S16	2324, 2387, 2570	409, 430, 436	S40900, S4300, S43600	M2
2.4	EN 1.4547	1.4547	X2CrNiMo20-18-6	HR41	2378	17-4PH	S31254	S2
3.1	EN 1561 - EN-JL1030	0.6010, 0.6040	GG10, GG40	Grade 150, Grade 400	0120, 0212, 0814	ASTM A48 class 20	F11401, F12801	K1
3.2	EN 1561 - EN-JL1050	0.6025, 0.6040	GG25, GG40	Grade200, Grade 400	0125, 0130, 0140, 0217	ASTM A48 class 40, STM A48 class 60	F12801, F14101	K2
3.3	EN 1561 - EN-JL2040	0.7040, 0.7070, 0.8145, 0.8045	GGG40, GGG70, GTS45-06, GTW45-07	420/12, P4407, 700/2, 30g/72	0219, 0717, 0727, 0732, 0852	ASTM A220 grade 40010, ASTM A602 grade M4504	F22830, F20001	K3
3.4	EN 1561 - EN-JL2050	0.7040, 0.7070, 0.8145, 0.8045	GGG40, GGG70, GTS45-06, GTW45-07	420/12, P4407, 700/2, 30g/72	0221, 0223, 0737, 0854	ASTM A220 grade 90001, ASTM A602 grade M6501	F26230, 20005	K4
4.1		3.7024LN	Ti99.8	TA1 to 9	Ti99.8	ASTM B265 grade 1	R50250	S1
4.2		3.7164LN, 3.7119LN	TiAl6V4, TiAl5Sn2	TA10 to 14, TA17	TiAl6V4, TiAl5Sn2	AMS4928	R54790	S2
4.3		3.7164LN, 3.7174LN, 3.7184LN	TiAl6V4, TiAl6V5Sn2, TiAl4MoSn2	TA10 to 13, TA28	TiAl6V5Sn2	AMS4928, AMS4971	R56400, R54790	S3
5.1		2.4060, 2.4086	Nickel 200, 270, N699.6	NA 11, NA12	Ni200, Ni270	Nickel 200, Nickel 230	N02200, N02230	S1
5.2		2.4630LN, 2.4602, 2.4650LN	Nimonic 75, Monel 400, Hastelloy C, Inconel 600	HR203, 3027-76		Nimonic 75, Monel 400, Hastelloy, Inconel 600	N06075, N10002, N04400, N06600	S2
5.3		2.4668LN, 2.4631LN, 2.6554LN	Inconel 718, Nimonic 80A, Waspaloy	HR8, HR401, 601		Inconel 718, 625, Nimonic 80	N07718, N07080, N06625	S3
6.1	EN 1652 - CW004A	2.0060, 2.0070	E-Cu57, SE-Cu	C101	5010	101	C10100, C1020	N3
6.2	EN 1652 - CW612N	2.0380, 2.0360, 2.1030, 2.1080	CuZn39Pb2, CuZn40, CuSn8, CuSn6Zn	CZ120, CZ109, PB104	5168		C28000, C37710	N4
6.3	EN 1652 - CW508L	2.0321, 2.0260	CuZn37, CuZn28	CZ108, CZ106	5150		C2800, C27200	N3
6.4			Ampco 18, Ampco 25	AB1 type	5238, JMT-20			N4
7.1	EN 485-2 - EN AW-1070A	3.0255	A99.5	LMO, 1 B (1050A)	4005	EC, 1060, 1100	A91060, A91100	N1
7.2	EN 755-2 - EN AW-5005	3.1355, 3.3525	AlCuMg2, AlMg2Mn0.8	LMS, 10, 12, N4 (5251)	4106, 4212	380, 520.0, 520.2, 2024, 6061	A03800, A05200, A92024	N1
7.3	EN 1706 - EN AC-42000	3.2162.05, 3.2341.01	GD-ALSi8Cu, G-ALSi8Mg	LM2.4, 16, 18, 21, 22., 24, 25, 26, 27, L109	4244	319.0, 333.0, 319.1, 356.0	A03190, A03330, C35600	N1
7.4	SS-EN 1706 - EN AC-47000	3.2581.01	G-ALSi18, G-ALSi12	LM6, 12, 13, 20, 28, 29, 30	4260, 4261, 4262	4032, 222.1, A332.0	A94032, A02220, A13320	N2
8.1			Polystyrene, Nylon, PVC Cellulose, Acetate & Nitrate			Polystyrene, Nylon, PVC		O
8.2			Ebonite, Tufnol, Bakelite			Bakelite		O
8.3			Kevlar, Printed Circuit boards			Kevlar		O
9.1			Ferrotic, Ferritanit					H
10.1			Graphite					O

Tabela Prędkości Obrotowych



		Vc															
m/min		5	8	10	15	20	25	30	40	50	60	70	80	90	100	110	150
stopy/min		16	26	32	50	66	82	98	130	165	197	230	262	296	330	362	495
Ø		obr/min															
mm	cale																
1,00		1592	2546	3183	4775	6366	7958	9549	12732	15916	19099	22282	25465	28648	31831	35014	47747
1,50		1061	1698	2122	3183	4244	5305	6366	8488	10610	12732	14854	16977	19099	21221	23343	31831
2,00		796	1273	1592	2387	3183	3979	4775	6366	7958	9549	11141	12732	14324	15916	17507	23873
2,50		637	1019	1273	1910	2546	3183	3820	5093	6366	7639	8913	10186	11459	12732	14006	19099
3,00		531	849	1061	1592	2122	2653	3183	4244	5305	6366	7427	8488	9549	10610	11671	15916
3,18	1/8	500	801	1001	1501	2002	2502	3003	4004	5005	6006	7007	8008	9009	10010	11011	15015
3,50		455	728	909	1364	1819	2274	2728	3638	4547	5457	6366	7276	8185	9095	10004	13642
4,00		398	637	796	1194	1592	1989	2387	3183	3979	4775	5570	6366	7162	7958	8754	11937
4,50		354	566	707	1061	1415	1768	2122	2829	3537	4244	4951	5659	6366	7074	7781	10610
4,76	3/16	334	535	669	1003	1337	1672	2006	2675	3344	4012	4681	5350	6018	6687	7356	10031
5,00		318	509	637	955	1273	1592	1910	2546	3183	3820	4456	5093	5730	6366	7003	9549
6,00		265	424	531	796	1061	1326	1592	2122	2653	3183	3714	4244	4775	5305	5836	7958
6,35	1/4	251	401	501	752	1003	1253	1504	2005	2506	3008	3509	4010	4511	5013	5514	7519
7,00		227	364	455	682	909	1137	1364	1819	2274	2728	3183	3638	4093	4547	5002	6821
7,94	5/16	200	321	401	601	802	1002	1203	1604	2004	2405	2806	3207	3608	4009	4410	6013
8,00		199	318	398	597	796	995	1194	1592	1989	2387	2785	3183	3581	3979	4377	5968
9,00		177	283	354	531	707	884	1061	1415	1768	2122	2476	2829	3183	3537	3890	5305
9,53	3/8	167	267	334	501	668	835	1002	1336	1670	2004	2338	2672	3006	3340	3674	5010
10,00		159	255	318	477	637	796	955	1273	1592	1910	2228	2546	2865	3183	3501	4775
11,11	7/16	143	229	287	430	573	716	860	1146	1433	1719	2006	2292	2579	2865	3152	4298
12,00		133	212	265	398	531	663	796	1061	1326	1592	1857	2122	2387	2653	2918	3979
12,70	1/2	125	201	251	376	501	627	752	1003	1253	1504	1754	2005	2256	2506	2757	3760
14,00		114	182	227	341	455	568	682	909	1137	1364	1592	1819	2046	2274	2501	3410
14,29	9/16	111	178	223	334	446	557	668	891	1114	1337	1559	1782	2005	2228	2450	3341
15,00		106	170	212	318	424	531	637	849	1061	1273	1485	1698	1910	2122	2334	3183
15,88	5/8	100	160	200	301	401	501	601	802	1002	1203	1403	1604	1804	2004	2205	3007
16,00		99	159	199	298	398	497	597	796	995	1194	1393	1592	1790	1989	2188	2984
17,46	11/16	91	146	182	273	365	456	547	729	912	1094	1276	1458	1641	1823	2005	2735
18,00		88	141	177	265	354	442	531	707	884	1061	1238	1415	1592	1768	1945	2653
19,05	3/4	84	134	167	251	334	418	501	668	835	1003	1170	1337	1504	1671	1838	2506
20,00		80	127	159	239	318	398	477	637	796	955	1114	1273	1432	1592	1751	2387
24,00		66	106	133	199	265	332	398	531	663	796	928	1061	1194	1326	1459	1989
25,00		64	102	127	191	255	318	382	509	637	764	891	1019	1146	1273	1401	1910
27,00		59	94	118	177	236	295	354	472	589	707	825	943	1061	1179	1297	1768
30,00		53	85	106	159	212	265	318	424	531	637	743	849	955	1061	1167	1592
32,00		50	80	99	149	199	249	298	398	497	597	696	796	895	995	1094	1492
36,00		44	71	88	133	177	221	265	354	442	531	619	707	796	884	973	1326
40,00		40	64	80	119	159	199	239	318	398	477	557	637	716	796	875	1194
50,00		32	51	64	95	127	159	191	255	318	382	446	509	573	637	700	955

HV Vickers	HRC Rockwell	HB Brinell	N/ mm ²	Tons/ sq. in.
940	68			
900	67			
864	66			
829	65			
800	64			
773	63			
745	62			
720	61			
698	60			
675	59			
655	58		2200	142
650		618	2180	141
640		608	2145	139
639	57	607	2140	138
630		599	2105	136
620		589	2070	134
615	56	584	2050	133
610		580	2030	131
600		570	1995	129
596	55	567	1980	128
590		561	1955	126
580		551	1920	124
578	54	549	1910	124
570		542	1880	122
560	53	532	1845	119
550		523	1810	117
544	52	517	1790	116
540		513	1775	115
530		504	1740	113
527	51	501	1730	112
520		494	1700	110
514	50	488	1680	109
510		485	1665	108
500		475	1630	105
497	49	472	1620	105
490		466	1595	103
484	48	460	1570	102
480		456	1555	101
473	47	449	1530	99
470		447	1520	98
460		437	1485	96
458	46	435	1480	96
450		428	1455	94
446	45	424	1440	93
440		418	1420	92

HV Vickers	HRC Rockwell	HB Brinell	N/ mm ²	Tons/ sq. in.
434	44	413	1400	91
423	43	402	1360	88
413	42	393	1330	86
403	41	383	1300	84
392	40	372	1260	82
382	39	363	1230	80
373	38	354	1200	78
364	37	346	1170	76
355	36	337	1140	74
350		333	1125	73
345	35	328	1110	72
340		323	1095	71
336	34	319	1080	70
330		314	1060	69
327	33	311	1050	68
320		304	1030	67
317	32	301	1020	66
310	31	295	995	64
302	30	287	970	63
300		285	965	62
295		280	950	61
293	29	278	940	61
290		276	930	60
287	28	273	920	60
285		271	915	59
280	27	266	900	58
275		261	880	57
272	26	258	870	56
270		257	865	56
268	25	255	860	56
265		252	850	55
260	24	247	835	54
255	23	242	820	53
250	22	238	800	52
245		233	785	51
243	21	231	780	50
240		228	770	50
235		223	755	49
230		219	740	48
225		214	720	47
220		209	705	46
215		204	690	45
210		199	675	44
205		195	660	43
200		190	640	41

Tol	Ø mm							
	> 1 ≤ 3	> 3 ≤ 6	> 6 ≤ 10	> 10 ≤ 18	> 18 ≤ 30	> 30 ≤ 50	> 50 ≤ 80	> 80 ≤ 120
	µm							
e8	-14 / -28	-20 / -38	-25 / -47	-32 / -59	-40 / -73	-50 / -89	-60 / -106	-72 / -126
f6	-6 / -12	-10 / -18	-13 / -22	-16 / -27	-20 / -33	-25 / -41	-30 / -49	-36 / -58
f7	-6 / -16	-10 / -22	-13 / -28	-16 / -34	-20 / -41	-25 / -50	-30 / -60	-36 / -71
h6	0 / -6	0 / -8	0 / -9	0 / -11	0 / -13	0 / -16	0 / -19	0 / -22
h7	0 / -10	0 / -12	0 / -15	0 / -18	0 / -21	0 / -25	0 / -30	0 / -35
h8	0 / -14	0 / -18	0 / -22	0 / -27	0 / -33	0 / -39	0 / -46	0 / -54
h9	0 / -25	0 / -30	0 / -36	0 / -43	0 / -52	0 / -62	0 / -74	0 / -87
h10	0 / -40	0 / -48	0 / -58	0 / -70	0 / -84	0 / -100	0 / -120	0 / -140
h11	0 / -60	0 / -75	0 / -90	0 / -110	0 / -130	0 / -160	0 / -190	0 / -220
h12	0 / -100	0 / -120	0 / -150	0 / -180	0 / -210	0 / -250	0 / -300	0 / -350
k10	+40 / 0	+48 / 0	+58 / 0	+70 / 0	+84 / 0	+100 / 0	+120 / 0	+140 / 0
k12	+100 / 0	+120 / 0	+150 / 0	+180 / 0	+210 / 0	+250 / 0	+300 / 0	+350 / 0
m7	+2 / +12	+4 / +16	+6 / +21	+7 / +25	+8 / +29	+9 / +34	+11 / +41	+13 / +48
js14	+/- 125	+/- 150	+/- 180	+/- 215	+/- 260	+/- 310	+/- 370	+/- 435
js16	+/- 300	+/- 375	+/- 450	+/- 550	+/- 650	+/- 800	+/- 950	+/- 1100
H7	+10 / 0	+12 / 0	+15 / 0	+18 / 0	+21 / 0	+25 / 0	+30 / 0	+35 / 0
H8	+14 / 0	+18 / 0	+22 / 0	+27 / 0	+33 / 0	+39 / 0	+46 / 0	+54 / 0

1µm = 0.001mm

WIERCENIE

OGÓLNE WSKAZÓWKI DOT. WIERCENIA

1. Wybór wiertła najlepiej nadających się do danego zastosowania musi uwzględniać obrabiany materiał, właściwości narzędzia skrawającego i chłodzenie.
2. Niestabilność obrabianego przedmiotu i wrzeciona narzędzia mogą uszkodzić wiertła, obrabiany przedmiot i maszynę - należy zwrócić uwagę na maksymalną stabilność. Powinno się wybierać zawsze możliwie najkrótsze wiertło dla danego zastosowania.
3. Mocowanie narzędzia jest ważnym elementem procesu wiercenia. Nie można dopuścić do sytuacji, w której zamocowane wiertło ślizga się lub rusza w uchwycie.
4. Zaleca się używanie odpowiedniego chłodziwa i smaru dla konkretnego zastosowania. Stosując chłodziwo i smar należy zapewnić odpowiednią jego ilość podczas wiercenia.
5. Podczas wiercenia decydujące znaczenie ma odprowadzanie wiórów. Wióry nie powinny nigdy pozostawać wewnątrz rowków wiórowych wiertła.
6. Przy przeszlifowywaniu wiertła należy zawsze uważać na to, aby uzyskać prawidłowy kąt wierzchołkowy wiertła i usunąć wszelkie ślady zużycia krawędzi.

ROZMIARY OTWORÓW

W miarę jak geometria, materiały bazowe i powłoki ulegają dalszemu rozwojowi, udaje się uzyskiwać coraz bardziej precyzyjne rozmiary otworu. Wiertło o standardowej geometrii może ogólnie rzecz biorąc zagwarantować tolerancję otworu H12. Jednak im geometria wiertła staje się bardziej złożona, tym bardziej wymiar otworu jaki udaje się uzyskać w sprzyjających warunkach, może odpowiadać tolerancji H8. Dla lepszej orientacji zestawiono poniżej typy produktów i osiągalne tolerancje otworów.

- Wiertła uniwersalne HSS – H12
- Wiertła do głębokich otworów HSS / HSS-E z parabolicznymi rowkami – H10
- Wysokowydajne wiertła powlekane z węgla spiekane – H8/H9

WIERCENIE GŁĘBOKICH OTWORÓW

W przypadku wiercenia głębokich otworów, można zastosować jedną z kilku dostępnych metod. Poniższy przykład pokazuje cztery sposoby wykonania otworu, gdzie głębokość otworu to 10-krotność średnicy.

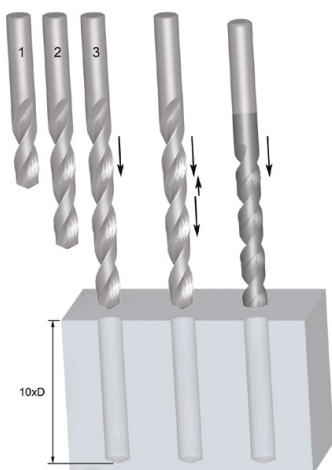

	Wiercenie seryjne	Wiercenie seryjne
Liczba wiertel	3 (2,5xD, 6xD, 10xD)	2 (2,5xD, 10xD)
Typ wiertła	Geometria standardowa, wiertła uniwersalne	Geometria standardowa, wiertła uniwersalne
+ / -	Drogie Wymagające dużo czasu	Bardziej ekonomiczne Szybkie

	Wiercenie z wycofywaniem	Wiercenie ze stałym posuwem
Liczba wiertel	1 (10xD)	1 (10xD)
Typ wiertła	Geometria standardowa, wiertła uniwersalne	Zastosowanie odpowiednich narzędzi
+ / -	Wymagające dużo czasu	Ekonomiczne Szybkie

ROZWIĄZYWANIE PROBLEMÓW PODCZAS WIERCENIA

PROBLEM	PRZYCZYNA	ŚRODEK ZARADCZY
Złamane lub zdeformowane chwyt	Złe osadzenie między oprawką a chwytem	Oprawka i chwyt muszą być czyste i nieuszkodzone
Pęknięcie w rdzeniu	Za wysoki posuw	Wybrać właściwy posuw
	Zbyt mały kąt przyłożenia	Prawidłowo przeszlifować
	Pocieniony ścin	Prawidłowo przeszlifować
	Uderzenie na ścin	Unikać uderzeń na ścin. Należy postępować ostrożnie z wiertłami MK podczas mocowania/ wyciągania ich z wrzeciona
Zużycie narożników	Nadmierna prędkość	Zmniejszyć prędkość do optimum - ew. zwiększenie posuwu
Wyszczerbienie naroży	Niestabilne mocowanie detalu	Usunąć luz mocowania detalu
Wyszczerbienie krawędzi skrawającej	Zbyt duży kąt przyłożenia	Prawidłowo przeszlifować
Pęknięcie ujścia rowka wiórowego	Zatykanie się rowków wiórowych	Zastosować wycofywanie wiertła/ używać wiercenia seryjnego
	Wiertło ślizga się	Upewnić się, że wiertło jest dobrze osadzone w uchwycie zaciskowym i wrzecionie
Zła jakość powierzchni otworu (spirała)	Zbyt mały posuw	Zwiększyć posuw
	Mała precyzja pozycjonowania	Zastosować wstępne nawiercanie
Zbyt duża średnica otworu	Nieprawidłowy kąt wierzchołkowy	Sprawdzić kąt wierzchołkowy
	Niedostateczna głębokość rowka wiórowego	Odpowiednio dostosować pręđ. obrotową, posuw i głębokość wycofywania, by uzyskać lepsze odprowadzanie wiórów

ROZWIERCANIE

UWAGI OGÓLNE O ROZWIERCANIU

W celu uzyskania najlepszych wyników podczas stosowania rozwiertaków, istotne jest, aby przede wszystkim spełniały swoją rolę. Powszechnym błędem w przygotowaniu otworów do rozwiercania jest pozostawienie zbyt małego naddatku. Jeżeli przed rozwiercaniem w otworze pozostawiony jest zbyt mały naddatek, wówczas rozwiertak będzie się ślizgał i przycierał, wykazując zużycie, co będzie skutkowało utratą średnicy. Dla uzyskania odpowiedniego rezultatu równie ważne jest niepozostawianie zbyt dużego naddatku w otworze (patrz usuwanie naddatku poniżej).

1. Wybierać optymalny rodzaj rozwiertaka oraz optymalne prędkości i posuwy dla danego zastosowania. Dopilnować, aby wstępnie wywiercone otwory posiadały prawidłową średnicę.
2. Obrabiany przedmiot musi być zamocowany sztywno, a wrzeciono obrabiarki nie powinno mieć luzów.
3. Uchwyt, w którym mocowany jest rozwiertak o prostym chwycie musi być dobrej jakości. Jeżeli rozwiertak ślizga się w uchwycie, a posuw jest automatyczny, może dojść do pęknięcia rozwiertaka.
4. Utrzymywać minimalny wysięg narzędzia z wrzeciona obrabiarki.
5. W celu zwiększenia trwałości rozwiertaka używać zalecanych środków smarujących i dopilnować, aby ciecz docierała do krawędzi skrawania. Ponieważ rozwiercanie nie jest operacją ciężkiego skrawania, zwykle wystarcza roztwór oleju rozpuszczalnego w proporcji 40:1. Podczas obróbki na sucho, do żeliwa szarego może być używany nadmuch powietrza.
6. Nie dopuścić do zablokowania rowków wiórowych rozwiertaka przez drobne opiłki.
7. Przed ostrzeniem rozwiertaka, sprawdzić współosiowość pomiędzy kłami. W większości przypadków, ostrzenia będzie wymagała tylko powierzchnia skośna.
8. Używać rozwiertaków naostrzonych. Częste ostrzenie jest ekonomicznie uzasadnione, lecz ważne jest, że rozwiertaki skrawają tylko powierzchniami skośnym i stożkowymi, a nie powierzchniami styku. Oznacza to, że jedynie te powierzchnie wymagają ostrzenia. Dokładność ostrzenia jest ważna dla jakości otworu i trwałości narzędzia.

USUWANIE NADDATKU

Zalecane usunięcie naddatku w rozwiercaniu zależy od materiału obrabianego oraz wykończenia powierzchni wstępnie wywierconego otworu. Ogólne wskazówki dotyczące usuwania naddatku pokazano w poniższych tabelach:

Wielkość rozwiercanego otworu (mm)	Gdy wstępnie wywiercony	Gdy wstępnie wiercony rdzeniowo	Wielkość rozwiercanego otworu (cale)	Gdy wstępnie wywiercony	Gdy wstępnie wiercony rdzeniowo
Poniżej 4	0.1	0.1	Poniżej 3/16	0.004	0.004
Ponad 4 do 11	0.2	0.15	3/16 do 1/2	0.008	0.006
Ponad 11 do 39	0.3	0.2	1/2 do 1,1/2	0.010	0.008
Ponad 39 do 50	0.4	0.3	1,1/2 do 2	0.016	0.010

GRANICE TOLERANCJI



1. INFORMACJE O TOLERANCJACH WYMIARÓW STANDARDOWYCH ROZWIERTAKÓW

Średnica (d_1) jest mierzona w poprzek obwodowej powierzchni styku, bezpośrednio za prowadzeniem skosu lub stożka. Tolerancja jest zgodna z DIN 1420 i przeznaczona jest do wykonywania otworów w tolerancji H7.

TOLERANCJA ROZWIERTAKÓW			
Średnica (mm)		Granica tolerancji (mm)	
Ponad	Do i włącznie	Wysoka +	Niska +
	3	0.008	0.004
3	6	0.010	0.005
6	10	0.012	0.006
10	18	0.015	0.008

TOLERANCJA ROZWIERTAKÓW			
Średnica (mm)		Granica tolerancji (mm)	
Ponad	Do i włącznie	Wysoka +	Niska +
	30	0.017	0.009
18	30	0.017	0.009
30	50	0.021	0.012
50	80	0.025	0.014

2. O OTWORZE H7

Najczęstsza tolerancja obrobionego otworu to H7 (patrz tabela poniżej). Dla każdej innej tolerancji, można zastosować rysunek i tabelę w punkcie 3, aby obliczyć położenie i szerokość tolerancji rozwiertaka.

TOLERANCJA OTWORU			
Średnica (mm)		Granica tolerancji (mm)	
Ponad	Do i włącznie	Wysoka +	Niska +
	3	0.010	0
3	6	0.012	0
6	10	0.015	0
10	18	0.018	0

TOLERANCJA OTWORU			
Średnica (mm)		Granica tolerancji (mm)	
Ponad	Do i włącznie	Wysoka +	Niska +
	30	0.021	0
18	30	0.021	0
30	50	0.025	0
50	80	0.030	0

3. Gdy istnieje konieczność zdefiniowania wymiarów specjalnego rozwiertaka przeznaczonego do skrawania z określoną tolerancją, np., D8, można skorzystać z tego sprawdzonego przewoźnika.

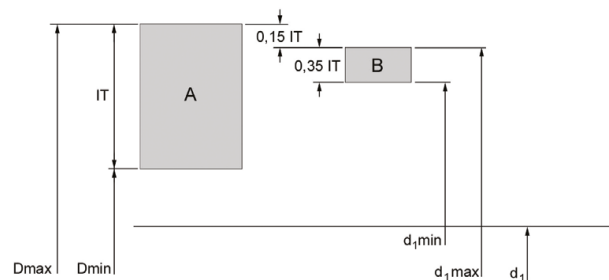

A = Tolerancja Otworu
 B = Tolerancja Rozwiertaków
 IT = Szerokość tolerancji
 Dmax = Maks. średnica otworu
 Dmin = Min. średnica otworu
 d_1 = Średnica znamionowa
 $d_{1,max}$ = Maks. średnica rozwiertaka
 $d_{1,min}$ = Min. średnica rozwiertaka

Szerokość tolerancji (mikrony)	Średnica (mm)							
	ponad 1 włącznie z 3	ponad 3 włącznie z 6	ponad 6 włącznie z 10	ponad 10 włącznie z 18	ponad 18 włącznie z 30	ponad 30 włącznie z 50	ponad 50 włącznie z 80	ponad 80 włącznie z 120
IT5	4	5	6	8	9	11	13	15
IT6	6	8	9	11	13	16	19	22
IT7	10	12	15	18	21	25	30	35
IT8	14	18	22	27	33	39	46	54
IT9	25	30	36	43	52	62	74	87
IT10	40	48	58	70	84	100	120	140
IT11	60	75	90	110	130	160	190	220
IT12	100	120	150	180	210	250	300	350

np. 10 mm otwór o tolerancji D8, Maks. śred. = 10,062, Min. śred. = 10,040, Tol. otworu (IT8) = 0,022

Maksymalna granica: $0,15 \times$ tolerancja otworu (IT8) = 0,0033, w zaokrągleniu = 0,004

Minimalna granica: $0,35 \times$ tolerancja otworu (IT8) = 0,0077, w zaokrągleniu = 0,008

Maksymalna granica dla rozwiertaka = 10,062 - 0,004 = 10,058

Maksymalna granica dla rozwiertaka = 10,058 - 0,008 = 10,050

ROZWIĄZYWANIE PROBLEMÓW PODCZAS ROZWIERCANIA

PROBLEM	PRZYCZYNA	ŚRODEK ZARADCZY
Uszkodzone lub zdeformowane chwyt	Nieprawidłowe pasowanie między uchwytem a uchwytem rozwiertaka	Uchwyt oraz chwyt rozwiertaka muszą być czyste i nieuszkodzone
Szybkie zużycie narzędzia	Nieodpowiednia ilość naddatku do usunięcia	Zwiększyć ilość naddatku do usunięcia
Zbyt duży otwór	Zbyt duża różnica wysokości krawędzi	Prawidłowo przeszlifować
	Niewłaściwe ustawienia wrzeciona maszyny	Poprawić i ustawić wrzeciono we właściwy sposób
	Ugięcie uchwyty narzędzia	Wymienić uchwyt narzędzia
	Chwyt narzędzia jest uszkodzony	Wymienić lub przeszlifować chwyt
	Owalność narzędzia	Wymienić lub przeszlifować narzędzie
	Asymetryczny kąt skosu wiodącego	Prawidłowo przeszlifować
	Zbyt duży posuw lub zbyt wysoka prędkość	Dostosować warunki skrawania zgodnie z Katalogiem
Zbyt mały otwór	Nieodpowiednia ilość naddatku do usunięcia	Zwiększyć ilość naddatku do usunięcia
	Zbyt duża ilość ciepła wytworzona podczas rozwiercania. Otwór rozszerza się i kurczy	Zwiększyć przepływ chłodziwa
	Średnica narzędzia jest zużyta i zbyt mała	Prawidłowo przeszlifować
	Zbyt niski posuw lub zbyt niska prędkość	Dostosować warunki skrawania zgodnie z Katalogiem
	Wstępnie wywiercony otwór jest zbyt mały	Zmniejszyć ilość naddatku do usunięcia
Otwory owalne i stożkowe	Niewłaściwe ustawienia wrzeciona maszyny	Poprawić i ustawić wrzeciono we właściwy sposób
	Niewspółosiowość pomiędzy narzędziem i otworem	Użyć rozwiertaka mostkowego
	Asymetryczny kąt skosu wiodącego	Prawidłowo przeszlifować
Złe wykończenie otworu	Nadmierna ilość naddatku do usunięcia	Zmniejszyć ilość naddatku do usunięcia
	Zużyte narzędzie	Prawidłowo przeszlifować
	Zbyt mały kąt natarcia ostrza	Prawidłowo przeszlifować
	Zbyt rozcieńczona emulsja lub olej do skrawania	Zwiększyć zawartość %
	Zbyt niski posuw lub zbyt niska prędkość	Dostosować warunki skrawania zgodnie z Katalogiem
	Zbyt wysoka prędkość skrawania	Dostosować warunki skrawania zgodnie z Katalogiem
Narzędzie zakleszcza się i łamie	Zużyte narzędzie	Prawidłowo przeszlifować
	Zbieżność narzędzia jest zbyt mała	Sprawdź i wymień/napraw narzędzie
	Zbyt duża szerokość powierzchni ostrza	Sprawdź i wymień/napraw narzędzie
	Obrabiany materiał ulega ściskaniu	Użyć regulowanego rozwiertaka, aby skorygować przemieszczenie
	Wstępnie wywiercony otwór jest zbyt mały	Zmniejszyć ilość naddatku do usunięcia
	Niejednorodny materiał z twardymi wtrąceniami	Użyć rozwiertaka z węgla spiekanego

FREZOWANIE GWINTÓW

OGÓLNE WSKAZÓWKI DOTYCZĄCE FREZOWANIA GWINTÓW

Frezowanie gwintów to rodzaj obróbki polegający na wykonywaniu gwintu metodą interpolacji kołowej za pomocą freza do gwintów o określonej geometrii gwintu, szlifowanego obwodowo.

Do obróbki z użyciem frezów do gwintów niezbędna jest obrabiarka sterowana numerycznie z funkcją prowadzenia narzędzia po drodze kołowej.

W większości nowoczesnych obrabiarek CNC dostępne są cykle obróbkowe do frezowania gwintów

W celu uzyskania dalszych informacji, należy zapoznać się z podręcznikiem lub skontaktować z dostawcą obrabiarki

WŁAŚCIWOŚCI I KORZYŚCI

Frezowanie gwintów zwiększa niezawodność i wydłuża czas eksploatacji narzędzia

Frezy do gwintów wytwarzają mniejsze wióry, dzięki czemu obróbka przebiega bezproblemowo

Regulacje tolerancji mogą być dokonywane z wykorzystaniem dokładnych współrzędnych

Można wykonywać pełniejszy gwint do dna otworu

Możliwość obróbki szerokiej gamy materiałów

To samo narzędzie może być używane do różnych średnic, o ile skok pozostaje niezmienny

Jedno narzędzie można wykorzystać do obróbki gwintów lewo- i prawoskrętnych

Niektóre frezy do gwintów mogą być również wykorzystywane do fazowania (J200, J205, J260)

WYBÓR NARZĘDZI

Wszystkie frezy do gwintów są oznakowane kodem narzędzia określającym typ, średnicę (d_1) i skok (P)

Podczas zamawiania narzędzia należy podać odpowiadający mu kod

Przy wyborze odpowiedniego narzędzia należy zawsze sprawdzić w katalogu, czy wybrane zostały odpowiednie rozmiary gwintu

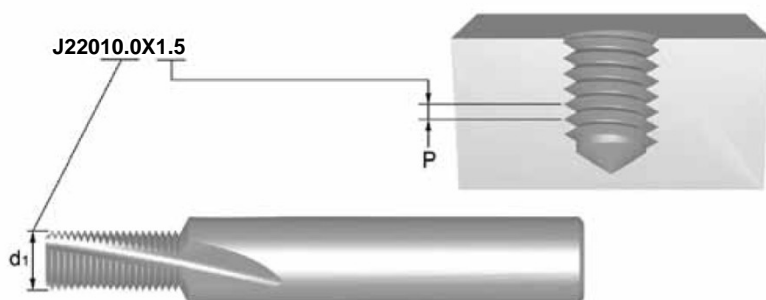

Te frezy do gwintów można stosować do wykonywania gwintów $\geq M12 \times 1.5$ (M14x1.5, M18x1.5 itd)

PROGRAMOWANIE Z Rprg

- Aby w łatwy sposób dostosować tolerancję gwintu podczas programowania, należy zawsze uwzględnić korekcję promienia
- Wartość Rprg, nadrukowana na chwycie narzędzia, jest wartością początkową dla nowego freza. Wartość ta powinna zostać wprowadzona do pamięci obrabiarki
- Wartość Rprg bazuje na teoretycznej linii zerowej gwintu, co oznacza, że w przypadku pracy z wykorzystaniem Rprg gwinty nigdy nie będą zbyt duże, ale zwykle będą zbyt mocno dopasowane
- To oznacza, że aby wykonać gwint o wymaganej wielkości, należy zmodyfikować współrzędne programu o niewielką wartość

ZALECENIA

- Zawsze należy używać właściwych parametrów skrawania
- Należy zastosować zalecaną średnicę otworu pod gwint, jak w przypadku konwencjonalnych gwintowników
- Aby w łatwy sposób dostosować tolerancję gwintu zawsze należy rozpoczynać od wartości Rprg nadrukowanej na chwycie freza do gwintów
- Aby upewnić się, czy konieczna jest korekta promienia, należy dokonać sprawdzenia klasy dokładności na pierwszym gwincie. Przed całkowitym zużyciem się freza do gwintów, promień powinien zostać korygowany 2- lub 3-krotnie
- Przy obróbce na sucho, zalecane jest stosowanie sprężonego powietrza, ułatwiającego usuwanie wiórów
- W przypadku trudnych materiałów zaleca się, by operację frezowania gwintów przeprowadzać w 2 lub 3 przejściach

GWINTOWANIE

OGÓLNE WSKAZÓWKI DOT. GWINTOWANIA OTWORÓW

Sukces każdej operacji gwintowania zależy od wielu czynników, przy czym mają one wszystkie wpływ na jakość gotowego produktu.

1. Wybrać z tabeli klasyfikacji materiałowej prawidłową geometrię gwintownika na podstawie obrabianego materiału i typu otworu (np. wiercenie otworu przelotowego lub nieprzelotowego).
2. Narzędzie musi być dobrze zamocowane - ruch poprzeczny może prowadzić do złej jakości gwintu, a nawet do złamania gwintownika.
3. Wybrać właściwy rozmiar wiertła z odpowiedniej strony w katalogu. Zawsze należy się upewnić, że utwardzenie powierzchniowe materiału jest utrzymywane na minimalnym poziomie.
4. Wybrać prawidłową prędkość skrawania ze strony zbiorczej katalogu gwintowników..
5. Zastosować odpowiednią ciecz chłodząco-smarującą do danej aplikacji.
6. W zastosowaniach NC (numerycznie sterowanych) wartości posuwu powinny być prawidłowe dla wybranego programu. W przypadku użycia przyrządu z kompensacją osiową posuw należy wybrać na poziomie 95 % do 97% skoku, żeby gwintownik bez nacisku wchodził w materiał.
7. Także w przypadku użycia przyrządu z kompensacją osiową, wyposażonego w sprzęgło bardzo ważne jest, żeby gwintownik pracował bez dociskania i odciągania. Chroni to również gwintownik przed pęknięciem w przypadku dojścia gwintownika do dna otworu (otwór nieprzelotowy).
8. Gwintownik powinien wchodzić w otwór z równomiernym posuwem, ponieważ nierównomierny posuw może prowadzić do rozszerzenia gwintu przy końcu obrabianego otworu.

TABELA TOLERANCJI GWINTOWNIKÓW W PORÓWNANIU Z TOLERANCJĄ GWINTÓW WEWNĘTRZNYCH (NAKRĘTKI)

Klasa tolerancji, gwintowniki			Tolerancja, gwinty wewnętrzne (nakrętki)					Zastosowanie
ISO	DIN	ANSI BS						
ISO 1	4 H	3 B	4 H	5 H				Naddatek na obróbkę otworu
ISO 2	6 H	2 B	4 G	5 G	6 H			Prawidłowe pasowanie
ISO 3	6 G	1 B			6 G	7 H	8 H	Pasowanie z większym luzem
-	7 G	-				7 G	8 G	Nadwyżka wymiarowa dla dodatkowej obróbki powierzchni lub nakładania powłok

ROZWIĄZYWANIE PROBLEMÓW ZWIĄZANYCH Z GWINTOWANIEM

PROBLEM	PRZYCZYNA	ŚRODEK ZARADCZY
Nadwymiar	Nieprawidłowa tolerancja	Wybrać gwintownik z mniejszym zakresem tolerancji gwintu.
	Wybrano nieprawidłowy posuw osiowy	Zmniejszyć wartość posuwu o 5-10 % lub sprawdzić nacisk przyrządu gwintującego.
	Nieprawidłowy typ gwintownika dla danego zastosowania	Użyć prostorowkowanego gwintownika z rowkiem wiórowym do otworów przelotowych lub spiralnie rowkowanego gwintownika do otworów nieprzelotowych. Przestrzegać zaleceń dotyczących wyboru prawidłowych narzędzi podanych w katalogu Dormera lub w "Product Selectorze".
	Gwintownik nie pracuje centrycznie	Sprawdzić zamocowanie gwintownika i ustawić środek gwintownika nad otworem.
	Niedostateczne smarowanie	Zadbać o dobre smarowanie, by uniknąć tworzenia się narostu. Patrz rozdział o smarach w Poradniku Technicznym.
	Zbyt niskie obroty gwintownika	Przestrzegać zaleceń z katalogu lub "Product Selectorza"
Podwymiar	Nieprawidłowy typ gwintownika dla danego zastosowania	Użyć prostorowkowanego gwintownika z rowkiem wiórowym do otworów przelotowych lub spiralnie rowkowanego gwintownika do otworów nieprzelotowych. Przestrzegać zaleceń dotyczących wyboru prawidłowych narzędzi podanych w katalogu Dormera lub w "Product Selectorze".
	Nieprawidłowa tolerancja	Należy wybrać gwintownik z większym zakresem tolerancji, szczególnie w przypadku materiałów z niewielką tendencją do nadwymiaru, jak żeliwo, stal nierdzewna.
	Złe smarowanie lub brak smarowania	Stosować dobre smarowanie, by uniknąć blokowania się wiórów w otworze. Patrz rozdział o smarach w Poradniku Technicznym.
	Zbyt wąski otwór pod gwint	Zwiększyć średnicę wiertła do wartości maksymalnej. Sprawdzić średnicę wierconego otworu.
	Zbyt ciasny gwint po wykonaniu gwintownika	Stosować się do zaleceń dotyczących wyboru prawidłowego narzędzia podanych w katalogu Dormera lub "Product Selectorza"
Wykruszenia na narzędziu	Nieprawidłowy typ gwintownika dla danego zastosowania	Użyć gwintownika z mniejszym kątem natarcia. Użyć gwintownika z dłuższym nakrojem. Użyć gwintowników z rowkiem wiórowym do otworów przelotowych a spiralnie rowkowanych do otworów nieprzelotowych, by uniknąć blokowania się wiórów. Przestrzegać zaleceń dotyczących wyboru prawidłowych narzędzi podanych w katalogu Dormera lub w "Product Selectorze".
	Zły lub brakujący środek smarujący	Stosować dobre smarowanie, by uniknąć blokowania się wiórów w otworze. Patrz rozdział o smarach w Poradniku Technicznym.
	Gwintownik dotyka dna wierconego otworu	Zwiększyć głębokość otworu pod gwint lub zmniejszyć głębokość gwintowania.
	Samoutwardzanie powierzchni	Zmniejszyć prędkość, używać powlekanych narzędzi, stosować dobre środki smarujące. Patrz rozdział o obróbce stali nierdzewnej w Poradniku Technicznym.
	Blokada wiórów w przypadku rewersu	Zwrócić uwagę na moment przełączenia z biegu w prawo na bieg w lewo.
	Nakrój natrafia na krawędź otworu	Sprawdzić położenie osiowe i zmniejszyć błąd osiowy.
	Zbyt wąski otwór pod gwint	Zwiększyć średnicę wiercenia do maksymalnej wartości. Sprawdzić średnicę wierconego otworu.

ROZWIĄZYWANIE PROBLEMÓW ZWIĄZANYCH Z GWINTOWANIEM

PROBLEM	PRZYCZYNA	ŚRODEK ZARADCZY
Pęknięcie gwintownika	Zbyt duże zużycie gwintownika	Użyć nowego gwintownika lub stary przeostrzyć.
	Niewystarczające smarowanie	Stosować dobre smarowanie, by uniknąć tworzenia się narostu i zablokowania się wiórów. Patrz rozdział o smarach w Poradniku Technicznym.
	Gwintownik dotyka dna otworu	Zwiększyć głębokość otworu lub zmniejszyć głębokość gwintowania.
	Zbyt wąski gwint po procesie gwintowania	Zmniejszyć szybkość skrawania. Przestrzegać zaleceń w katalogu lub "Product Selectorze".
	Samoutwardzanie powierzchni	Zmniejszyć prędkość, używać powlekanego narzędzia, stosować dobre smarowanie. Patrz rozdział o obróbce stali nierdzewnej w Poradniku Technicznym.
	Zbyt ciasny otwór pod gwint	Zwiększyć średnicę wiercenia do maksymalnej wartości. Patrz tabele gwintowników.
	Zbyt wysoki moment obrotowy	Użyć przyrząd gwintujący ze sprzęgłem z regulacją momentu obrotowego.
	Kurczenie się materiału po gwintowaniu	Przestrzegać zaleceń dotyczących wyboru prawidłowych narzędzi zawartych w katalogu Dormera lub "Product Selectorze".
Zbyt szybkie zużycie	Nieprawidłowy typ gwintownika dla danego zastosowania	Zastosować gwintownik z mniejszym kątem natarcia ostrza i/lub większym skrzętem i/lub dłuższym nakrojem. W miarę możliwości stosować pokrywane narzędzie. Przestrzegać zaleceń dotyczących wyboru prawidłowych narzędzi podanych w katalogu Dormera lub w "Product Selectorze".
	Niewystarczające smarowanie	Stosować dobre smarowanie, by uniknąć tworzenia się narostu i termicznego obciążenia skrawania. Patrz rozdział o smarach w Poradniku Technicznym.
	Zbyt wysoka prędkość gwintowania	Zmniejszyć prędkość. Przestrzegać zaleceń z katalogu lub "Product Selectorza".
Tworzenie się narostu	Nieprawidłowy typ gwintownika dla danego zastosowania	Zastosować gwintownik z mniejszym kątem natarcia ostrza i/lub większym skrzętem. Przestrzegać zaleceń dotyczących wyboru prawidłowych narzędzi podanych w katalogu Dormera lub w "Product Selectorze".
	Brak smarowania	Stosować dostateczną ilość smaru, by uniknąć narostu. Patrz rozdział o smarach w Poradniku Technicznym.
	Sposób obróbki powierzchni jest nieodpowiedni	Wybierz gwintownik z odpowiednią obróbką powierzchni/pokryciem.
	Prędkość gwintowania otworu zbyt niska	Przestrzegać zaleceń z katalogu Dormera lub "Product Selectorza".

Frezowanie

OGÓLNE WSKAZÓWKI DOTYCZĄCE FREZOWANIA

Frezowanie jest to proces obróbki, podczas którego usuwana jest z obrabianego przedmiotu określona ilość materiału za pomocą obracającego się freza pracującego z odpowiednim posuwem.

Charakterystyczną cechą procesu frezowania jest to, że każdy ząb freza usuwa materiał w postaci możliwie najmniejszych wiórów.

TYPY FREZÓW

Trzy podstawowe operacje frezowania pokazane zostały niżej: (A) frezowanie współbieżne, (B) frezowanie czołowe i (C) frezowanie walcowo-czołowe.

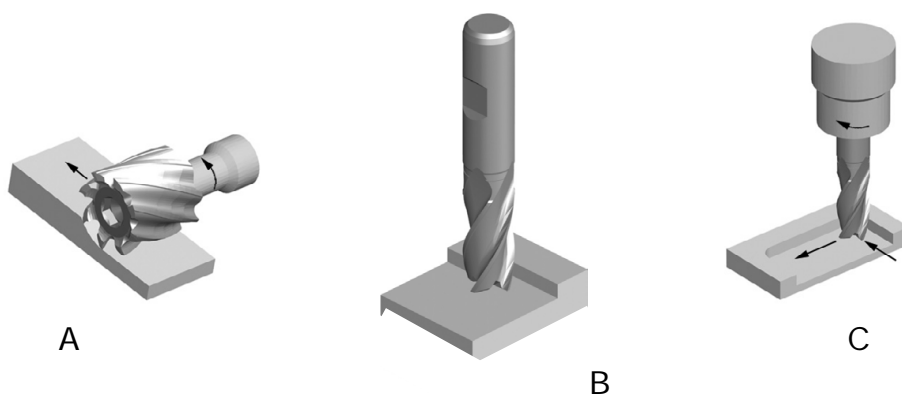

W przypadku frezowania powierzchni czołowych oś rotacji ustawiona jest równoległe do obrabianej powierzchni. Frez ma zęby wzdłuż obwodu koła. Każdy ząb działa samodzielnie.

Frezy stosowane do frezowania powierzchni obrotowych, mają zęby proste lub skręte.

W przypadku frezowania czołowego frez umieszczany jest we wrzecionie. Oś obrotu jest prostopadła do obrabianej powierzchni. Proces frezowania realizowany jest przez krawędzie czołowe freza.

W przypadku frezowania walcowo-czołowego frez obraca się wzdłuż osi pionowej do obrabianej powierzchni. Może też zostać pochylony, żeby obrobić powierzchnie skośne. Narzędzie skrawa także na bokach i ma uzębienie czołowe.

ZASTOSOWANIA

Objętość skrawania i zastosowanie są mocno od siebie zależne. Dla wszystkich różnych zastosowań istnieją różne objętości skrawania. W nowym katalogu Dormera zastosowania zostały oznaczone prostymi symbolami. Możliwe są następujące obróbki:

Frezowanie boczne	Frezowanie czołowe	Frezowanie rowków wpustowych	Frezowanie wgłębne	Frezowanie ukośne
Promieniowa głębokość frezowania powinna być mniejsza niż $0.25 \times D$ freza walcowo-czołowego.	Promieniowa głębokość frezowania powinna odpowiadać wartości nie większej niż $0.9 \times D$, a osiowa głębokość nie mniejszej niż $0.1 \times D$.	Frezowanie rowków wpustowych. Promieniowa głębokość rowka powinna być nie większa niż średnica freza.	Używać tylko narzędzi skrawających czołowo. Posuw zmniejszyć o połowę.	Możliwa jest zarówno osiowa jak i promieniowa obróbka przedmiotu.

ROZWIĄZYWANIE PROBLEMÓW ZWIĄZANYCH Z FREZOWANIEM

PROBLEM	PRZYCZYNA	ŚRODEK ZARADCZY
Pęknięcie	Za duży przekrój skrawania	Zmniejszyć posuw przypadający na ząb
	Za duży posuw	Zmniejszyć posuw
Zużycie	Zbyt duża długość rowków lub całkowita długość	Zastosować krótsze zamocowanie lub krótszy frez
	Zbyt twardy materiał przedmiotu obrabianego	Użyć katalogu lub "Product Selector", żeby wybrać bardziej odporne na zużycie lub lepsze do danego celu pokrycie.
	Nieprawidłowy posuw i liczba obrotów	Wybrać poprawne parametry obróbki z katalogu lub Product Selector
	Utrudnione odprowadzanie wiórów	Zadbać o dobre chłodzenie i smarowanie
	Frezowanie przeciwbieżne	Frezowanie współbieżne
	Nieodpowiedni kąt skrętu rowka wiórowego	W celu wybrania odpowiedniego narzędzia alternatywnego patrz katalog lub Product Selector.
Wyszczerbienie się krawędzi tnącej	Zbyt wysoka wartość posuwu	Zmniejszyć wartość posuwu
	Wibracje	Zmniejszyć liczbę obrotów
	Niska prędkość obróbki	Zwiększyć liczbę obrotów
	Frezowanie przeciwbieżne	Frezowanie współbieżne
	Stabilność narzędzia	Wybrać krótsze narzędzie i/lub narzędzie krócej zamocować
	Stabilność obrabianego przedmiotu	Lepiej zamocować obrabiany przedmiot
Krótka trwałość narzędzia	Trudnoobrabialny materiał	W celu wybrania odpowiedniego narzędzia alternatywnego patrz katalog lub Product Selector.
	Nieodpowiedni kąt skrawania i kąt podstawowy	Wybrać narzędzie z odpowiednim kątem skrawania
	Zbyt wysokie tarcie	Stosować narzędzia powlekane
Zła jakość powierzchni	Zbyt wysoki posuw	Zmniejszyć do prawidłowej wartości
	Za niska liczba obrotów	Zwiększyć liczbę obrotów
	Zbyt duże wióry	Zmniejszyć przekrój skrawania
	Zużycie narzędzia	Wymienić lub przeszlifować narzędzie
	Tworzenie się narostu	Zmienić na narzędzie z większym kątem skrętu rowka wiórowego
	Złe odprowadzenie wiórów	Zwiększyć ilość doprowadzanego chłodziwa

PROBLEM	PRZYCZYNA	ŚRODEK ZARADCZY
Niedokładność obrabianego przedmiotu	Odchylenie narzędzia	Wybrać krótsze narzędzie i/lub narzędzie krócej zamocować
	Niewystarczająca ilość ostrzy	Stosować narzędzie z większą ilością ostrzy
	Zniszczony lub uszkodzony uchwyt zaciskowy	Naprawić lub wymienić
	Niewystarczająca stabilność uchwytu zaciskowego	Zastosować krótszy lub bardziej stabilny uchwyt zaciskowy
	Zła stabilność wrzeciona	Zwrócić uwagę na stabilność wrzeciona
Wibracje	Zbyt wysoki posuw i prędkość	Skorygować posuw i prędkość za pomocą katalogu lub Product Selector.
	Zbyt długi frez	Zastosować krótsze zamocowanie lub krótszy frez czołowo-walcowy
	Zbyt duża głębokość frezowania	Zmniejszyć głębokość frezowania
	Stabilność obrabianego przedmiotu	Lepiej zamocować obrabiany przedmiot

WĘGLIKOWE PILNIKI OBROTOWE

OGÓLNE WSKAZÓWKI DOTYCZĄCE WĘGLIKOWYCH PILNIKÓW OBROTOWYCH

Węglkowe pilniki obrotowe są szeroko stosowane do przygotowywania i obróbki wykończeniowej przedmiotów wykonanych z rozmaitych materiałów.

Zwykle stosowane są w ręcznych pneumatycznych szlifierkach prostych

WŁAŚCIWOŚCI I KORZYŚCI

Chwyty wykonane z utwardzonej i hartowanej stali zapewniają lepszą sztywność, dzięki czemu zmniejszają ryzyko ugięcia oraz ograniczają występowanie drgań

Dokładnie szlifowane chwyt gwarantują pewniejsze mocowanie i ograniczają prawdopodobieństwo obracania się narzędzia

Specjalne wlotowane elementy zapobiegają uszkodzeniom spowodowanym wysoką temperaturą, a ponadto zapewniają zwiększoną wytrzymałość na nacisk i uderzenia

Uniwersalna geometria z podwójnym nakrojem (Double Cut) służy się do obróbki różnorodnych materiałów i szerokiej gamy zastosowań

Dostępne są również geometrie przeznaczone do określonych materiałów, takich jak stal (ST), stal nierdzewna (VA), aluminium (AL) i włókno szklane (GRP)

W ofercie znajdują się również pilniki z powłoką TiAlN, wydłużającą czas eksploatacji narzędzia w materiałach ściernych

Pilniki z czołem kulistym mają geometrię bez szlifowanego rowka

Ta geometria aktywnie wpływa na sposób pracy narzędzia w pobliżu osi, zapewniając sprawniejszy przebieg obróbki oraz zmniejszając tendencję do gromadzenia i zakleszczania się wiórów

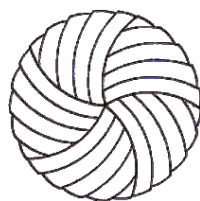

Przerywany

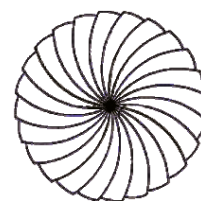

Normalny

NAJWAŻNIEJSZE JEST BEZPIECZEŃSTWO

W przypadku użycia niezgodnego z zaleceniami, narzędzia obrotowe do obróbki z wysokimi prędkościami mogą być niebezpieczne i stanowić zagrożenie

Przed wymianą pilnika zawsze należy odłączyć szlifierkę od źródła zasilania sprężonym powietrzem

Należy sprawdzić stan szlifierki prostej i jeśli to możliwe, używać wersji generującej niskie drgania

Należy zawsze korzystać z odpowiedniego wyposażenia ochronnego i upewnić się, że wszystkie osoby pracujące w pobliżu również korzystają ze środków ochrony



Należy zawsze stosować odzież ochronną.

ZALECENIA

- Zawsze używać szlifierek prostych o odpowiedniej znamionowej prędkości obrotowej
- Duże znaczenie ma regularne przeprowadzanie przeglądów szlifierek, upewniając się, czy poziom oleju jest odpowiedni i czy łożyska nie zostały zużyte
- Podczas wymiany pilnika zawsze należy oczyścić nakrętkę mocującą, tuleję zaciskową i wewnętrzny stożek
- Podczas korzystania z pilników obrotowych należy unikać wstrząsów mechanicznych i silnych uderzeń
- Unikać wstrząsów termicznych poprzez niedopuszczanie do przegrzewania się pilników
- Nie zagłębiać zbyt mocno pilników w obrabiany przedmiot, ani nie zakleszczać ich w narożach lub kanałach

Rozwiązywanie problemów występujących podczas UŻYTKOWANIA PILNIKÓW OBROTOWYCH

PROBLEM	PRZYCZYNA
Wykruszanie się ostrzy pilnika	Obróbka przy zbyt niskiej prędkości obrotowej może powodować odskakiwanie narzędzia
	Niewspółśrodkowość (zużyte wrzeciono, tuleja zaciskowa lub łożyska)
	Zagłębianie lub zakleszczanie pilnika w obrabianym przedmiocie
Zapychanie się ostrzy pilnika	Zbyt długi rowek lub długość całkowita
	Geometria dobrana niewłaściwie do obrabianego materiału
Przedwczesne zużycie	Obróbka ze zbyt dużą prędkością obrotową niedostosowaną do wielkości pilnika i obrabianego materiału
	Niewspółśrodkowość (zużyte wrzeciono, tuleja zaciskowa lub łożyska)
Odpadnięcie głowicy od chwytu	Obróbka ze zbyt dużą prędkością obrotową powodującą przegrzanie
	Zbyt długo trwająca obróbka prowadząca do przegrzania

Slovensky		Tvrdosť	Pevnosť v ťahu	ISO
Aplikačné materiálové skupiny		HB	N/mm ²	
1. Oceľ	1.1 Magneticky mäkká oceľ	< 120	< 400	P 1
	1.2 Konštrukčná oceľ, uhlíková	< 200	< 700	P 1
	1.3 Uhlíková oceľ	< 250	< 850	P 2
	1.4 Legovaná oceľ	< 250	< 850	P 3
	1.5 Legovaná oceľ, tvrdená a temperovaná	> 250 < 350	> 850 < 1200	P 4
	1.6 Legovaná oceľ, tvrdená a temperovaná	> 350	> 1200 < 1620	H 1
	1.7 Legovaná oceľ tvrdená	49-55HRC	> 1620	H 3
	1.8 Legovaná oceľ tvrdená, oceľ odolná oproti opotrebovaniu	55-63HRC	> 1980	H 4
2. Nehrdzavejúca oceľ	2.1 Automatová nehrdzavejúca oceľ	< 250	< 850	M 1
	2.2 Austenická	< 320	< 1100	M 3
	2.3 Ferritická + austenická, ferritická, martenzitická	< 300	< 1000	M 2
	2.4 Lamelárny grafit (sivá)	>320 <410	>1100 <1400	S 2
3. Zliatina	3.1 Lamelárny grafit	< 150	> 500	K 1
	3.2 Nodulárny grafit, temperovaná zliatina (tvárna)	> 150 <300	> 500 < 1000	K 2
	3.3 Nodulárny grafit, temperovaná zliatina (tvárna)	< 200	< 700	K 3
	3.4 Títan čistý	> 200 < 300	> 700 < 1000	K 4
4. Títan	4.1 Zliatiny títanu	< 200	< 700	S 1
	4.2 Zliatiny títanu	< 270	< 900	S 2
	4.3 Nikel čistý	> 270 < 350	> 900 ≤ 1250	S 3
5. Nikel	5.1 Zliatiny niklu	< 150	< 500	S 1
	5.2 Zliatiny niklu	< 270	> 900	S 2
	5.3 Med'	> 270 < 350	> 900 < 1200	S 3
6. Med'	6.1 β-mosadz	< 100	< 350	N 3
	6.2 α-mosadz	< 200	< 700	N 4
	6.3 Bronz vysokopevnostný	< 200	< 700	N 3
	6.4 Al, Mg, čistý	< 470	< 1500	N 4
7. Hliník, horčík	7.1 Al zliatiny, Si<0,5%	< 100	< 350	N 1
	7.2 Al zliatiny, Si>0,5%<10%	< 150	< 500	N 1
	7.3 Al zliatiny, Si>10%	< 120	< 400	N 1
	7.4 Zliatiny hliníka a horčíka	< 120	< 400	N 2
8. Syntetické materiály	8.1 Termoplasty	---	---	O
	8.2 Termosety	---	---	O
	8.3 Spevnené plasty	---	---	O
9. Tvrdé materiály	9.1 Cermet (kov-keramika)	< 550	< 1700	H
10. Grafit	10.1 Grafit	---	< 100	O

PRÍKLADY NÁSTROJOVÝCH MATERIÁLOV
 PODĽA RÔZNYCH ŠTANDARDOV

AMG	EN	W.Nr.	DIN	BS	SS	USA	UNS	ISO
1.1		1.1015, 1.1013	Rte60, Rte100	230M07, 050A12	1160	Lead Steels	G12120	P1
1.2	EN 10 025 - S235JRG2	1.1012, 1.1053, 1.7131	S137-2, 16MnCr5, S150-2	060A35, 080M40, 4360-50B	1312, 1412, 1914	135, 30	G10100	P1
1.3	EN 10 025 - E295	1.1191, 1.0601	CK45, C60	080M46, 080A62	1550, 2142, 2172	1024, 1060, 1061	G10600	P2
1.4	EN 10 083-1 - 42 CrMo4 - EN 10 270-2	1.7225, 1.3505, 1.6582, 1.3247	42CrMo4, 100Cr6, 34CrNiMo6, S2-10-1-8	708M40/42, 817M40, 534A99, BM2, BT42	1672-04, 2090, 2244-02, 2541-02	4140, A2, 4340, M42, M2	G41270, G41470, T30102, T11342	P3
1.5	EN ISO 4857 - H86-5-2 - EN ISO 4857 - H86-5-2.5	1.2510, 1.2713, 1.3247, 1.2080	100MnCrW12, 55NiCrMoV6, X210Cr12, S2-10-1-8	801, BM2, BT42, 826M40, 830M31	2244-04, 2541-03, 2550, 2722, 2723	01, L6, M42, D3, A2, M2, 4140, 8630	G96300, T30102, T11302, T30403, T11342	P4
1.6	EN ISO 4857 - HS2-9-1-8	1.2510, 1.2713, 1.3247, 1.2080	100MnCrW12, X210Cr12, S2-10-1-8	801, 826 M40, 830M31	2244-05, 2541-05, , HARDOX 400	01, L6, M42, D3, 4140, 8130	T30403, G41400, J14047	H1
1.7	EN ISO 4857 - HS2-9-1-8	1.2510	100MnCrW4	BO1, BO3, BH13	HARDOX 500			H3
1.8	EN ISO 4857 - X40CrMoV5-1	1.3343, 1.2344	S6-5-2, GX40CrMoV5-1	BM2, BH13	2242 HARDOX 600			H4
2.1	EN 10 088-3 - X14CrMoS17	1.4305, 1.4104	X10CrNiS189, X12CrMoS17	303 S21, 416 S37	2301, 2312, 2314, 2346, 2380	303, 416, 430F	S30300, S41600, S43020	M1
2.2	EN 10 088-2.0 - 3 - 1,4301+AT	1.4301, 1.4541, 1.4571	X5CrNiFe189, X10CrNiMoTi1810	304 S15, 321 S17, 316 S, 320 S12	2310, 2333, 2337, 2343, 2353, 2377	304, 321, 316	S30400, S32100, S31600	M3
2.3	EN 10 088-3 - 1,4460	1.4460, 1.4512, 1.4582	X8CrNiMo275, X4CrNiMoN6257	317 S16, 316 S16	2324, 2387, 2570	409, 430, 436	S40900, S4300, S43600	M2
2.4	EN 1,4547	1.4547	X2CrNiMo20-18-6	HR41	2378	17-4PH	S31254	S2
3.1	EN 1561 - EN-JL1030	0.6010, 0.6040	GG10, GG40	Grade150, Grade 400	0120, 0212, 0814	ASTM A48 class 20	F11401, F12801	K1
3.2	EN 1561 - EN-JL1050	0.6025, 0.6040	GG25, GG40	Grade200, Grade 400	0125, 0130, 0140, 0217	ASTM A48 class 40, STM A48 class 60	F12801, F14101	K2
3.3	EN 1561 - EN-JL2040	0.7040, 0.7070, 0.8145, 0.8045	GGC40, GGG70, GTS45-06, GTW45-07	420/12, P4407, 700/2, 30g/72	0219, 0717, 0727, 0732, 0852	ASTM A220 grade 40010, ASTM A602 grade M4504	F22830, F20001	K3
3.4	EN 1561 - EN-JL2050	0.7040, 0.7070, 0.8145, 0.8045	GGG40, GGG70, GTS45-06, GTW45-07	420/12, P4407, 700/2, 30g/72	0221, 0223, 0737, 0854	ASTM A220 grade 90001, ASTM A602 grade M8501	F26230, 20005	K4
4.1		3.7024LN	T199.8	TA1 to 9	T199.8	ASTM B265 grade 1	R50250	S1
4.2		3.7164LN, 3.7119LN	TiA6V4, TiA55n2	TA10 to 14, TA17	TiA6V4, TiA55n2	AMS4928	R54790	S2
4.3		3.7164LN, 3.7174LN, 3.7184LN	TiA6V4, TiA6V5Sn2, TiA4MoSn2	TA10 to 13, TA28	TiA6V5Sn2	AMS4928, AMS4971	R56400, R54790	S3
5.1		2.4060, 2.4066	Nickel 200, 270, N199.6	NA 11, NA12	Ni200, Ni270	Nickel 200, Nickel 230	N02200, N02230	S1
5.2		2.4630LN, 2.4602, 2.4650LN	Nimonic 75, Monel 400, Hastelloy C, Inconel 600	HR203, 3027-76		Nimonic 75 Monel400, Hastelloy, Inconel600	N06075, N10002, N04400, N06600	S2
5.3		2.4668LN, 2.4631LN, 2.6554LN	Inconel 718, Nimonic 80A, Waspaloy	HR8, HR401, 601		Inconel 718, 625, Nimonic 80	N07718, N07080, N06625	S3
6.1	EN 1652 - CW004A	2.0060, 2.0070	E-Cu57, SE-Cu	C101	5010	101	C10100, C1020	N3
6.2	EN 1652 - CW612N	2.0380, 2.0360, 2.1030, 2.1080	CuZn39Pb2, CuZn40, CuSn8, CuSh6Zn	CZ120, CZ109/PB104	5168		C28000, C37710	N4
6.3	EN 1652 - CW508L	2.0321, 2.0260	CuZn37, CuZn28	CZ108,CZ106	5150		C2600, C27200	N3
6.4			Ampco 18, Ampco 25	AB1 type	5238, JM7-20			N4
7.1	EN 485-2 - EN AW-1070A	3.0255	A199.5	LMO, 1 B (1050A)	4005	EC, 1060, 1100	A91060, A91100	N1
7.2	EN 755-2 - EN AW-5005	3.1355, 3.3525	AlCuMg2, AlMg2Mn0.8	LM5, 10, 12, N4 (5251)	4106, 4212	380, 520.0, 520.2, 2024, 6061	A03800, A05200, A92024	N1
7.3	EN 1706 - EN AC-42000	3.2162.05, 3.2341.01	GD-A1818Cu, G-A1S15Mg	LM2,4,16,18,21,22,,24,25,26,27,L109	4244	319.0, 333.0, 319.1, 356.0	A03190, A03330, C35600	N1
7.4	SS-EN 1706 - EN AC-47000	3.2581.01	G-A1S18, G-A1S12	LM6, 12,13, 20, 28, 29, 30	4260, 4261, 4262	4032, 222, 1, A332.0	A94032, A02220, A13320	N2
8.1				Polystyrene, Nylon, PVC Cellulose, Acetate & Nitrate		Polystyrene, Nylon, PVC		O
8.2				Ebonite, Tufnol, Bakelite		Bakelite		O
8.3				Kevlar, Primed Circuit boards		Kevlar		O
9.1				Ferrotic, Ferrotilant				H
10.1				Graphite				O

		Vc															
m/Min		5	8	10	15	20	25	30	40	50	60	70	80	90	100	110	150
Feet/Min		16	26	32	50	66	82	98	130	165	197	230	262	296	330	362	495
Ø		Otáčky za minútu															
mm	inch																
1,00		1592	2546	3183	4775	6366	7958	9549	12732	15916	19099	22282	25465	28648	31831	35014	47747
1,50		1061	1698	2122	3183	4244	5305	6366	8488	10610	12732	14854	16977	19099	21221	23343	31831
2,00		796	1273	1592	2387	3183	3979	4775	6366	7958	9549	11141	12732	14324	15916	17507	23873
2,50		637	1019	1273	1910	2546	3183	3820	5093	6366	7639	8913	10186	11459	12732	14006	19099
3,00		531	849	1061	1592	2122	2653	3183	4244	5305	6366	7427	8488	9549	10610	11671	15916
3,18	1/8	500	801	1001	1501	2002	2502	3003	4004	5005	6006	7007	8008	9009	10010	11011	15015
3,50		455	728	909	1364	1819	2274	2728	3638	4547	5457	6366	7276	8185	9095	10004	13642
4,00		398	637	796	1194	1592	1989	2387	3183	3979	4775	5570	6366	7162	7958	8754	11937
4,50		354	566	707	1061	1415	1768	2122	2829	3537	4244	4951	5659	6366	7074	7781	10610
4,76	3/16	334	535	669	1003	1337	1672	2006	2675	3344	4012	4681	5350	6018	6687	7356	10031
5,00		318	509	637	955	1273	1592	1910	2546	3183	3820	4456	5093	5730	6366	7003	9549
6,00		265	424	531	796	1061	1326	1592	2122	2653	3183	3714	4244	4775	5305	5836	7958
6,35	1/4	251	401	501	752	1003	1253	1504	2005	2506	3008	3509	4010	4511	5013	5514	7519
7,00		227	364	455	682	909	1137	1364	1819	2274	2728	3183	3638	4093	4547	5002	6821
7,94	5/16	200	321	401	601	802	1002	1203	1604	2004	2405	2806	3207	3608	4009	4410	6013
8,00		199	318	398	597	796	995	1194	1592	1989	2387	2785	3183	3581	3979	4377	5968
9,00		177	283	354	531	707	884	1061	1415	1768	2122	2476	2829	3183	3537	3890	5305
9,53	3/8	167	267	334	501	668	835	1002	1336	1670	2004	2338	2672	3006	3340	3674	5010
10,00		159	255	318	477	637	796	955	1273	1592	1910	2228	2546	2865	3183	3501	4775
11,11	7/16	143	229	287	430	573	716	860	1146	1433	1719	2006	2292	2579	2865	3152	4298
12,00		133	212	265	398	531	663	796	1061	1326	1592	1857	2122	2387	2653	2918	3979
12,70	1/2	125	201	251	376	501	627	752	1003	1253	1504	1754	2005	2256	2506	2757	3760
14,00		114	182	227	341	455	568	682	909	1137	1364	1592	1819	2046	2274	2501	3410
14,29	9/16	111	178	223	334	446	557	668	891	1114	1337	1559	1782	2005	2228	2450	3341
15,00		106	170	212	318	424	531	637	849	1061	1273	1485	1698	1910	2122	2334	3183
15,88	5/8	100	160	200	301	401	501	601	802	1002	1203	1403	1604	1804	2004	2205	3007
16,00		99	159	199	298	398	497	597	796	995	1194	1393	1592	1790	1989	2188	2984
17,46	11/16	91	146	182	273	365	456	547	729	912	1094	1276	1458	1641	1823	2005	2735
18,00		88	141	177	265	354	442	531	707	884	1061	1238	1415	1592	1768	1945	2653
19,05	3/4	84	134	167	251	334	418	501	668	835	1003	1170	1337	1504	1671	1838	2506
20,00		80	127	159	239	318	398	477	637	796	955	1114	1273	1432	1592	1751	2387
24,00		66	106	133	199	265	332	398	531	663	796	928	1061	1194	1326	1459	1989
25,00		64	102	127	191	255	318	382	509	637	764	891	1019	1146	1273	1401	1910
27,00		59	94	118	177	236	295	354	472	589	707	825	943	1061	1179	1297	1768
30,00		53	85	106	159	212	265	318	424	531	637	743	849	955	1061	1167	1592
32,00		50	80	99	149	199	249	298	398	497	597	696	796	895	995	1094	1492
36,00		44	71	88	133	177	221	265	354	442	531	619	707	796	884	973	1326
40,00		40	64	80	119	159	199	239	318	398	477	557	637	716	796	875	1194
50,00		32	51	64	95	127	159	191	255	318	382	446	509	573	637	700	955

HV	HRC	HB		
Vickers	Rockwell	Brinell	N/ mm ²	Tons/ sq. in.
940	68			
900	67			
864	66			
829	65			
800	64			
773	63			
745	62			
720	61			
698	60			
675	59			
655	58		2200	142
650		618	2180	141
640		608	2145	139
639	57	607	2140	138
630		599	2105	136
620		589	2070	134
615	56	584	2050	133
610		580	2030	131
600		570	1995	129
596	55	567	1980	128
590		561	1955	126
580		551	1920	124
578	54	549	1910	124
570		542	1880	122
560	53	532	1845	119
550		523	1810	117
544	52	517	1790	116
540		513	1775	115
530		504	1740	113
527	51	501	1730	112
520		494	1700	110
514	50	488	1680	109
510		485	1665	108
500		475	1630	105
497	49	472	1620	105
490		466	1595	103
484	48	460	1570	102
480		456	1555	101
473	47	449	1530	99
470		447	1520	98
460		437	1485	96
458	46	435	1480	96
450		428	1455	94
446	45	424	1440	93
440		418	1420	92

HV	HRC	HB		
Vickers	Rockwell	Brinell	N/ mm ²	Tons/ sq. in.
434	44	413	1400	91
423	43	402	1360	88
413	42	393	1330	86
403	41	383	1300	84
392	40	372	1260	82
382	39	363	1230	80
373	38	354	1200	78
364	37	346	1170	76
355	36	337	1140	74
350		333	1125	73
345	35	328	1110	72
340		323	1095	71
336	34	319	1080	70
330		314	1060	69
327	33	311	1050	68
320		304	1030	67
317	32	301	1020	66
310	31	295	995	64
302	30	287	970	63
300		285	965	62
295		280	950	61
293	29	278	940	61
290		276	930	60
287	28	273	920	60
285		271	915	59
280	27	266	900	58
275		261	880	57
272	26	258	870	56
270		257	865	56
268	25	255	860	56
265		252	850	55
260	24	247	835	54
255	23	242	820	53
250	22	238	800	52
245		233	785	51
243	21	231	780	50
240		228	770	50
235		223	755	49
230		219	740	48
225		214	720	47
220		209	705	46
215		204	690	45
210		199	675	44
205		195	660	43
200		190	640	41

Tol	Ø mm							
	> 1 ≤ 3	> 3 ≤ 6	> 6 ≤ 10	> 10 ≤ 18	> 18 ≤ 30	> 30 ≤ 50	> 50 ≤ 80	> 80 ≤ 120
	µm							
e8	-14 / -28	-20 / -38	-25 / -47	-32 / -59	-40 / -73	-50 / -89	-60 / -106	-72 / -126
f6	-6 / -12	-10 / -18	-13 / -22	-16 / -27	-20 / -33	-25 / -41	-30 / -49	-36 / -58
f7	-6 / -16	-10 / -22	-13 / -28	-16 / -34	-20 / -41	-25 / -50	-30 / -60	-36 / -71
h6	0 / -6	0 / -8	0 / -9	0 / -11	0 / -13	0 / -16	0 / -19	0 / -22
h7	0 / -10	0 / -12	0 / -15	0 / -18	0 / -21	0 / -25	0 / -30	0 / -35
h8	0 / -14	0 / -18	0 / -22	0 / -27	0 / -33	0 / -39	0 / -46	0 / -54
h9	0 / -25	0 / -30	0 / -36	0 / -43	0 / -52	0 / -62	0 / -74	0 / -87
h10	0 / -40	0 / -48	0 / -58	0 / -70	0 / -84	0 / -100	0 / -120	0 / -140
h11	0 / -60	0 / -75	0 / -90	0 / -110	0 / -130	0 / -160	0 / -190	0 / -220
h12	0 / -100	0 / -120	0 / -150	0 / -180	0 / -210	0 / -250	0 / -300	0 / -350
k10	+40 / 0	+48 / 0	+58 / 0	+70 / 0	+84 / 0	+100 / 0	+120 / 0	+140 / 0
k12	+100 / 0	+120 / 0	+150 / 0	+180 / 0	+210 / 0	+250 / 0	+300 / 0	+350 / 0
m7	+2 / +12	+4 / +16	+6 / +21	+7 / +25	+8 / +29	+9 / +34	+11 / +41	+13 / +48
js14	+/- 125	+/- 150	+/- 180	+/- 215	+/- 260	+/- 310	+/- 370	+/- 435
js16	+/- 300	+/- 375	+/- 450	+/- 550	+/- 650	+/- 800	+/- 950	+/- 1100
H7	+10 / 0	+12 / 0	+15 / 0	+18 / 0	+21 / 0	+25 / 0	+30 / 0	+35 / 0
H8	+14 / 0	+18 / 0	+22 / 0	+27 / 0	+33 / 0	+39 / 0	+46 / 0	+54 / 0

1µm = 0.001mm

Vrtanie

Všeobecné pokyny k vrtaniu

1. Vyberte vrták, ktorý sa na dané využitie hodí najviac, berte do úvahy obrábaný materiál, vlastnosti stroja a použitie chladenia.
2. Nepresnosti v súososti a nestabilita vretena môžu zapríčiniť zničenie vrtáku aj obrábanej súčiastky - vždy zabezpečte maximálnu možnú stabilitu. Tá sa dá zlepšiť použitím najkratšieho možného vrtáku pre danú operáciu.
3. Upnutie nástroja je pri vrtaní dôležité, vrták nesmie byť pri vrtaní zatlačený, ani vyťahnutý z upínača.
4. Upnutie vrtákov s Morse stopkou musí byť správne nastavené, dosedacie plochy musia byť čisté, používajte gumové kladivo na narazenie vrtáku do upínača.
5. Pri vrtaní sa odporúča použiť chladenie a mazanie, ktoré musí byť privedené na špičku vrtáku v dostatočnej miere a bez prerušovania.
6. Pri vrtaní je základom správny odvod materiálu vo forme triesok. Triesky sa nesmú zasekávať v drážkach vrtáku.
7. Pri prebrusovaní vrtáku dbajte na dodržiavanie geometrie špičky a odstráňte akékoľvek opotrebovanie.

ROZMER DIERY

Substráty a povlaky sú stále vylepšované, schopnosť vrtat' presnejšie diery sa zlepšuje. Štandardný vrták všeobecne dosahuje presnosť diery v tol. H12. Najlepšie vrtáky s komplexnou geometriou dosahujú pri splnení určitých podmienok diery v tolerancii H8. Nižšie uvádzame typy vrtákov a tolerancie, ktoré sú schopné dosiahnuť:

- HSS základný vrták – H12
- HSS / HSCo vrták s parabolickou konštrukciou drážky (PFX) – H10
- Karbidové výkonné vrtáky s povlakom TiN / TiALN (MPX) – H8/H9

Vrtanie hlbokých dier

Pri vrtaní hlbokých dier je možné použiť rôzne metódy. Uvedený príklad ukazuje štyri spôsoby vrtania diery do hĺbky 10 x priemer vrtáku.

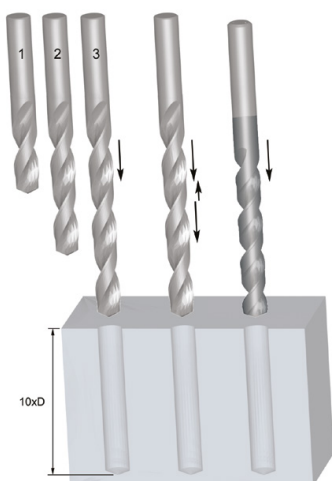

	Postupné vrtanie	Postupné vrtanie
Počet vrtákov	3 (2,5xD, 6xD, 10xD)	2 (2,5xD, 10xD)
Typ vrtáku	Bežná geometria, všeobecné využitie	Bežná geometria, všeobecné využitie
+ / -	Drahý Časovo náročný	Cenovo výhodnejší, rýchly

	Vyťahovacie cykly	Vrtanie na jeden priechod
Počet vrtákov	1 (10xD)	1 (10xD)
Typ vrtáku	Bežná geometria, všeobecné využitie	Nástroje so špecifickým použitím
+ / -	Časovo náročné	Cenovo výhodné a rýchle

RIEŠENIE PROBLÉMOV PRI VRTANÍ

Problém	Dôsledok	Riešenie
Zlomený alebo skrútený unášač	Nesprávne upnutie stopky do upínača.	Uistite sa, že stopka aj upínač sú čisté a bez poškodenia
Rozlomenie jadra vrtáku	Prirýchly posuv	Znížte posuv na optimum
	Nedostatočné začiatočné podbrúsenie	Prebrúste na správne hodnoty
	Privysoké obrusovanie jadra	Prebrúste na správne hodnoty
	Tvrdý náraz pri špičke	Vyvarujte sa nárazov na špičku. Stopkové vrtáky upínajte a vyťahujte opatrne.
Opotrebované vonkajšie rohy	Vysoká rýchlosť	Znížte reznú rýchlosť na optimum - s možnosťou zvýšenia posunu
Zničené vonkajšie rohy	Nestabilné nastavenie súčiastky	Znížte pohyb súčiastky
Vylámané brity	Príliš veľké podbrúsenie chrbta	Prebrúste na správne hodnoty
Zlomenie vrtáku	Upchávanie drážok	Použite opakované výjazdy vrtákov
	Skĺznutie vrtáka	Uistite sa, že vrták je bezpečne upnutý a nemôže preklzovať
Špirálovité stopy na obrobenom povrchu	Nedostatočný posuv	Zvýšte posuv
	Zlá pozičná presnosť	Pred vrtaním použite navíťavák
Priveľká diera	Nesprávna geometria	Skontrolujte správnosť geometrie špičky v oblasti prebrúsenia
	Nedostatočný odchod triesky	Nastavte rýchlosť, posuv a vyťahovanie tak, aby bol odchod triesky dostatočný

Vrtanie hlbokých dier

Všeobecné pokyny k vystružovaniu

Aby výstružníky dosiahli najlepšie výsledky, musíte ich nechať pracovať. Častou chybou býva veľká predvrtaná diera s príliš malým prídavkom na vystružovanie. Pokiaľ má výstružník málo materiálu na branie, nemôže správne odrezávať materiál, odiera sa a predčasne sa opotrebuje, rozmer diery je tak nesprávny. Na druhej strane je dôležité nenechávať prídavok príliš veľký, (odporúčané hodnoty v tabuľke na strane oproti).

1. Zvoľte správny typ výstružníka a rezné dáta na danú aplikáciu. Uistite sa, že predvrtané diery majú správny rozmer.
2. Obrobok musí byť pevne upnutý a vreteno by nemalo mať vôľu.
3. Klieština, v ktorej je výstružník upnutý, musí byť pevná a kvalitná. Pokiaľ výstružník zachádza do klieštiny a posuv je strojný, hrozí nebezpečenstvo zalomenia nástroja.
4. Držte vyloženie nástroja čo najkratšie.
5. Používajte odporúčané lubrikanty a zaistite, aby sa kvapalina dostala k britom. Vystružovanie nie je náročná obrábacia operácia, preto stačí emulzia v koncentrácii 40:1. Vyfukovanie vzduchom môže byť použité pri obrábaní šedej zliatiny za sucha.
6. Drážky výstružníka nesmú byť upchávané trieskami.
7. Pred prebrúsením výstružníka skontrolujte súososť medzi hrotmi. Pri väčšine prípadov stačí prebrúsiť iba nábeh.
8. Výstružníky udržiavajte nabrúsené. Prebrusovanie je ekonomické a pri včasnom brúsení stačí brúsiť len kuželový nábeh. Presnosť brúsenia je dôležitá pre kvalitu diery a životnosť nástroja.

ODBER MATERIÁLU

Odporúčaný prídavok závisí od aplikácie, materiálu a na kvalite povrchu predvrtanej diery. Všeobecné odporúčanie je v nasledovnej tabuľke:

Priemer vystružovanej diery (mm)	Predvrtanie	S predvrtaním výhrubníkom	Priemer vystružovanej diery (palce)	Predvrtanie	S predvrtaním výhrubníkom
pod 4	0.1	0.1	pod 3/16	0.004	0.004
Od 4 do 11	0.2	0.15	3/16 od 1/2	0.008	0.006
Od 11 do 39	0.3	0.2	1/2 od 1.1/2	0.010	0.008
Od 39 do 50	0.4	0.3	1.1/2 od 2	0.016	0.010

TOLERANCIA PRI VYSTRUŽOVANÍ



1. VÝROBNÁ TOLERANCIA PRIEMERU VÝSTRUŽNÍKA

Priemer (d_1) sa meria na valcovej fazetke, hneď za nábehom. Tolerancie sa riadia podľa normy DIN 1420 a sú nastavené tak, aby vystružené diery boli v tol. H7.

TOLERANCIA VÝSTRUŽNÍKA			
priemer (mm)		tolerančné pole (mm)	
cez	až do a vrátane	horný MR +	dolný MR +
	3	0.008	0.004
3	6	0.010	0.005
6	10	0.012	0.006
10	18	0.015	0.008

TOLERANCIA VÝSTRUŽNÍKA			
priemer (mm)		tolerančné pole (mm)	
cez	až do a vrátane	horný MR +	dolný MR +
	30	0.017	0.009
30	50	0.021	0.012
50	80	0.025	0.014

2. DIERA H7

Najčastejšia tolerancia vystružených dier býva H7 (viz tabuľka). Pre všetky ostatné tolerancie môže byť použitá ďalší nasledovná tabuľka, ktorá udáva polohu a šírku tolerančného poľa.

TOLERANCIA DIERY			
priemer (mm)		tolerančné pole (mm)	
cez	až do a vrátane	horný MR +	dolný MR +
	3	0.010	0
3	6	0.012	0
6	10	0.015	0
10	18	0.018	0

TOLERANCIA DIERY			
priemer (mm)		tolerančné pole (mm)	
cez	až do a vrátane	horný MR +	dolný MR +
	30	0.021	0
30	50	0.025	0
50	80	0.030	0

3. Ak je nutné definovať rozmery špeciálneho výstružníka na dosiahnutie špecifickej tolerancie, napr. D8, môže byť použitý tento návod.

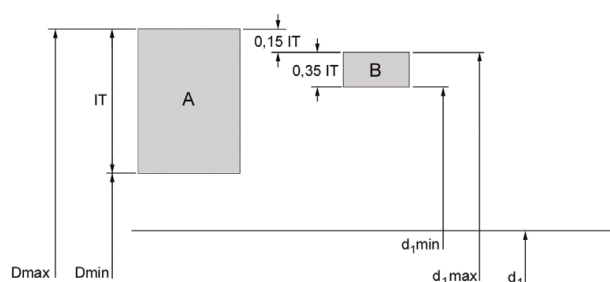

A = tolerancia diery
 B = tolerancia výstružníka
 IT = šírka tolerančného poľa
 Dmax = horný medzný rozmer diery
 Dmin = dolný medzný rozmer diery
 d_1 = nominálny priemer
 $d_{1,max}$ = maximálny priemer výstružníka
 $d_{1,min}$ = minimálny priemer výstružníka

tolerancia (microns)	Priemery a šírka tolerančného poľa (mm)							
	od 1 vrátane 3	od 3 vrátane 6	od 6 vrátane 10	od 10 vrátane 18	od 18 vrátane 30	od 30 vrátane 50	od 50 vrátane 80	od 80 vrátane 120
IT5	4	5	6	8	9	11	13	15
IT6	6	8	9	11	13	16	19	22
IT7	10	12	15	18	21	25	30	35
IT8	14	18	22	27	33	39	46	54
IT9	25	30	36	43	52	62	74	87
IT10	40	48	58	70	84	100	120	140
IT11	60	75	90	110	130	160	190	220
IT12	100	120	150	180	210	250	300	350

príklad: diera priem. 10 mm

s toleranciou D8, Horný medzný rozmer diery = 10.062, Spodný medzný rozmer diery = 10.040, Tolerancia diery (IT8) = 0.022

Horný: $0.15 \times$ tolerancia diery (IT8) = 0.0033, zaokrouhlené = 0.004

Spodný: $0.35 \times$ tolerancia diery (IT8) = 0.0077, zaokrouhlené = 0.008

Maximálny priemer výstružníka = $10.062 - 0.004 = 10.058$

Minimálny priemer výstružníka = $10.058 - 0.008 = 10.050$

Riešenie problémov pri vystružovaní

Problém	Dôsledok	Riešenie
Zlomený alebo prekrútený unášač	Nesprávne upnutie stopky do upínača	Uistite sa, že stopka aj upínač sú čisté a bez poškodenia
Rychlé opotrebovanie nástroja	Nedostatočný prídavok materiálu	Zvýšte prídavok materiálu na vystružovanie
Priveľká diera	Nesprávna poloha vretena	Opravte, vyrovnajte pozíciu vretena
	Nesúososť medzi nástrojom a dierou	Použite výstružník s dlhým kuželovým nábehom
	Asymetricky nabrúsený nábehový uhol	Nabrúste správne podľa návodu
	Poškodená stopka nástroja	Vymeňte nástroj alebo stopku prebrúste
	Kruhovitosť nástroja	Vymeňte nástroj alebo ho prebrúste
	Asymetricky nabrúsený nábehový uhol	Prebrúste podľa správnej špecifikácie
	Príliš veľký posuv alebo rezná rýchlosť	Upravte rezné dáta podľa katalógu alebo Product Selectoru
Primalá diera	Nedostatočný prídavok materiálu	Zväčšite prídavok materiálu na vystružovanie
	Príliš veľké teplo pri vystružovaní. Diera sa roztiane a po vychladnutí zmrští.	Zvýšte objem chladenia
	Priemer nástroja je opotrebovaný a je pod minimálnym rozmerom.	Prebrúste podľa správnej špecifikácie
	Príliš pomalý posuv alebo malá rýchlosť	Nastavte rezné dáta podľa Product Selectoru
	Predvŕtaná diera je príliš malá	Zmenšite prídavok na vystružovanie (zväčšite predvŕtanú dieru)
Oválne a kuželové diery	Nástroj upnutý do vretena mimo os	Opravte nastavenie polohy vretena
	Nesúososť medzi nástrojom a dierou	Použite výstružník s dlhým kuželovým nábehom
	Asymetricky nabrúsený nábehový uhol	Nabrúste správne podľa návodu
Zlá kvalita povrchu diery	Priveľký prídavok materiálu	Zmenšite prídavok na vystružovanie
	Otupený nástroj	Prebrúste podľa špecifikácie
	Príliš malý uhol čela	Prebrúste podľa špecifikácie
	Nízka koncentrácia oleja v emulzii	Zvýšte koncentráciu kvapaliny
	Príliš nízka rezná rýchlosť a posuv	Nastavte rezné dáta podľa Katalógu alebo Selectoru
	Rezná rýchlosť príliš vysoká	Nastavte rezné dáta podľa Katalógu alebo Selectoru
Nástroj sa zasekáva, láme	Otupený nástroj	Prebrúste podľa správnej špecifikácie
	Malý spätný kužel na nástroji, odiera sa o materiál	Skontrolujte a vymeňte nástroj, alebo ho nahraďte za iný typ
	Príliš široká fazeta	Skontrolujte a vymeňte nástroj, alebo ho nahraďte za iný typ
	Obrábaný materiál má tendenciu sa zmršťovať	Použite nastaviteľný výstružník na kompenzáciu nepresnosti
	Predvŕtaná diera je príliš malá	Zmenšite prídavok na vystružovanie
	Rôznorodý materiál s tvrdými prímieskami	Použite karbidový výstružník

FRÉZOVANIE ZÁVITOV

VŠEOBECNÉ RADY O FRÉZOVANÍ ZÁVITOV

Frézovanie závitov je proces vytvárania závitov kruhovou interpoláciou frézy so špecifickou geometriou závitov brúsenou okolo jeho okraja

Aby bolo možné používať závitovaciu frézu, je nutné mať CNC stroj, ktorý môže vykonávať kruhové pracovné dráhy nástroja

Väčšina moderných CNC strojov disponuje obrábacími cyklami na frézovanie závitov

Bližšie informácie nájdete v návode alebo sa obráťte na dodávateľa stroja

VLASTNOSTI A PREDNOSTI

Frézovanie závitov prináša zvýšenú spoľahlivosť a životnosť nástroja

Pri frézovaní závitov sa vytvárajú menšie triesky, vďaka čomu sa závitov prípravujú jednoduchšie

Nastavenie tolerancie je možné vykonať pomocou presných súradníc

Môžete vytvoriť hlbší závit až po spodnú časť otvoru

Schopnosť obrábať širokú škálu materiálov

Rovnaká fréza môže vytvárať závitov rôznych rozmerov za predpokladu, že je ich stúpanie rovnaké

Pravý a ľavý závit je možné vytvárať rovnakým nástrojom

Niektoré závitovacie frézy môžu tiež obrábať vstupné čelo (J200, J205, J260)

VÝBER NÁSTROJA

Všetky závitovacie frézy majú kód položky určený podľa typu, priemeru (d_1) a stúpania závitov (P)

Kód položky je číslo, ktoré použijete pri objednaní nástroja

Vždy si pozrite katalóg a uistite sa, že máte správne rozmery závitov

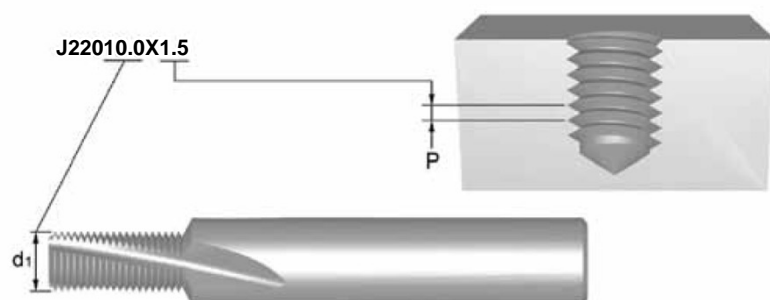

Táto závitovacia fréza môže byť použitá na závitov $\geq M12 \times 1,5$ ($M14 \times 1,5$, $M18 \times 1,5$ atď.)

PROGRAMOVANIE POMOCOU Rprg

- Na jednoduché nastavenie tolerancie závitú vždy vytvárajte program s korekciou polomeru
- Hodnota Rprg je počiatková hodnota pre novú frézu a je vytlačená na stopke frézy. Táto by mala byť zadávaná do offset pamäte nástroja
- Rprg vychádza z teoretickej nulovej línie závitú, čo znamená, že pri programovaní pomocou Rprg nebude závit zväčšený, ale bude riadne tesný
- To znamená, že s malou zmenou súradníc programu môžete vytvoriť závit požadovanej veľkosti

ODPORÚČANIA

- Vždy používajte správne rezné údaje
- Používajte odporúčané veľkosti vrtákov pre daný priemer závitú, ako v prípade konvenčných závitníkov
- Na jednoduché nastavenie tolerancie závitú vždy začnite s hodnotou Rprg vytlačenou na stopke frézy
- Pri prvom závite použite na kontrolu tolerancie meradlo, aby ste si zistili, či netreba polomer korigovať. Predtým ako sa závitovacia fréza opotrebuje, sa zvyčajne polomer koriguje 2- alebo 3-krát.
- Pri suchom obrábaní sa odporúča používať stlačený vzduch, ktorý pomáha pri odstraňovaní triesok
- Pri rezaní do náročnejších materiálov sa odporúča, aby sa operácia vykonala 2- alebo 3-krát

REZANIE ZÁVITOV

VŠEOBECNÉ POKYNY K REZANIU ZÁVITOV

Úspešnosť akejkoľvek závitovacej operácie závisí od mnohých faktorov, ktoré ovplyvňujú kvalitu vyrobeného závitu.

1. Vyberte závitník s vhodnou konštrukciou pre daný materiál obrobku a podľa toho, či je diera priechodná, alebo slepá, zvolte materiálovú skupinu obrobku.
2. Zabezpečte bezpečné upnutie obrobku - pokiaľ by sa pohl, zapríčinil by zlomenie závitníka a zlú kvalitu povrchu.
3. Zvoľte správny priemer vrtáka podľa tabuliek (pozri str. 76 - 79). Priemery vrtákov pod závit nájdete tiež na každom katalógovom liste závitníka. Pamätajte, že pod tvarované závity sa predvrtáva väčšia diera. Ubezpečte sa, že vytvrdzovanie povrchu pri vŕtaní je čo najmenšie, pozri kapitolu pojednávajúca o nehrdzavejúcich oceliach.
4. Zvoľte správnu reznú rýchlosť podľa indexu v katalógu, alebo podľa Product Selectoru.
5. Použite vhodnú reznú kvapalinu.
6. Pri NC obrábaní zaistite, aby bol naprogramovaný správny posuv. Pri použití pružných závitovacích hláv s kompenzáciou dĺžky je vhodné naprogramovať 95 - 97% hodnoty posuvu na stúpanie tak, aby bol závitník vlastnou silou tiahnutý do rezu (hlava je pritom vyťahovaná).
7. Pokiaľ to je možné, upínajte závitníky do kvalitných hláv s kontrolou krútiaceho momentu a s axiálnou kompenzáciou. Je to tiež ochrana proti chybám v programe, keď nástroj narazí do dna diery.
8. Závitník musí byť hladko a plynulo zavedený do diery, pokiaľ je posuv nepravidelný, dochádza rozhodnutiu začiatku závitu.

TABUĽKA TOLERANCIE ZÁVITNÍKA OPROTI TOLERANCII VNÚTORNÉHO ZÁVITU (MATICA)

Trieda tolerancie, závitník			Tolerancia, vnútorný závit (matica)					Použitie
ISO	DIN	ANSI BS						
ISO 1	4 H	3 B	4 H	5 H				Uloženie bez vôle
ISO 2	6 H	2 B	4 G	5 G	6 H			Normálne uloženie
ISO 3	6 G	1 B			6 G	7 H	8 H	Uloženie s veľkou vôľou
-	7 G	-				7 G	8 G	Voľné uloženie pre následnú povrchovú úpravu alebo povlakovanie

RIEŠENIE PROBLÉMOV PRI REZANÍ

Problém	Dôsledok	Riešenie
Voľný závit	Nesprávna tolerancia	Zvoľte závitník s tesnejšou toleranciou
	Nesprávny axiálny posuv	Znížte posuv o 5 - 10% (v pružnej hlave) alebo zvýšte tlak upínača
	Nevhodný typ závitníka pre aplikáciu	Pre priechodné diery použite závitník s priamou drážkou a lámačom, na slepé diery použite špirálovitý závitník. Povlakovaným nástrojom znížite možnosť tvorby nárastku. Preverte alternatívne produkty v Selectore, alebo katalógu.
	Závitník nie je v diere vystredovaný	Skontrolujte upínač a pozíciu, musí byť v ose diery.
	Nedostatočná lubrikácia	Používajte kvalitnú lubrikáciu, ktorá zabráni tvorbe nárastku. Pozri kapitola o lubrikácii v technickej príručke
	Rezná rýchlosť príliš nízka	Dodržiavajte odporúčania z katalógu alebo Selectoru.
Tesný závit	Nevhodný typ závitníka pre aplikáciu	Na priechodné diery použite závitník s priamou drážkou a lámačom, na slepé diery použite špirálovitý závitník. Povlakovaným nástrojom znížite možnosť tvorby nárastku. Použite závitník s väčším uhlom čela. Preverte alternatívne produkty v Selectore alebo katalógu.
	Nesprávna tolerancia	Zvoľte závitník s voľnejšou toleranciou, obzvlášť do materiálov, ktoré majú tendenciu zmrštiť sa (nerez), alebo abrazívnych materiálov (liatina).
	Nedostatočná alebo nevhodná lubrikácia	Použite kvalitný lubrikant, ktorý predíde zasekávaniu triesok v diere. Pozri kapitola o lubrikácii v technickej príručke
	Predvrtaná diera príliš malá	Zväčšite priemer vrtáku na maximálnu hodnotu. Pozri tabuľka vrtákov pod závit.
	Predvrtaná diera príliš veľká	Skontrolujte odporúčané parametre a vhodné alternatívy v katalógu alebo Selectore.
Zasekávanie triesok	Nevhodný typ závitníku na danú operáciu	Zvoľte závitník s menším uhlom čela. Zvoľte závitník s dlhším nábehom. Do priechodných dier používajte závitník s priamou drážkou, do slepých špirálovitý, zabránite zasekávaniu triesok. Skontrolujte v katalógu alebo Selectore alternatívne vhodné závitníky.
	Nevhodná alebo nedostatočná lubrikácia	Použite kvalitný lubrikant, ktorý predíde zasekávaniu triesok v diere. Pozri kapitola o lubrikácii v technickej príručke
	Závitník naráža do dna	Zvýšte hĺbku vrtania, alebo znížte hĺbku závitovania
	Povrch diery sa obrábaním vytvrdzuje	Znížte reznú rýchlosť, použite vhodný lubrikant. Pozri kapitola o obrábaní nerez v technickej príručke
	Zasekávanie triesok pri výjazde	Vyhňte sa náhlemu návratu závitníka pri spätnom pohybe.
	Úkos naráža do vchodu diery	Skontrolujte axiálnu polohu a znížte odchýlku od osi na minimum
	Predvrtaná diera príliš malá	Zväčšite priemer vrtáku na maximum. Pozri tabuľky vrtákov pod závit.

RIEŠENIE PROBLÉMOV PRI REZANÍ

Problém	Dôsledok	Riešenie
Zlomenie	Otupený závitník	Použite nový závitník, alebo prebrúste otupený
	Nedostatočná lubrikácia	Použite kvalitný lubrikant, ktorý predíde zasekávaniu triesok v diere. Pozri kapitola o lubrikácii v technickej príručke
	Závitník naráža do dna diery	Zvýšte hĺbku vrtania, alebo znížte hĺbku závitovania
	Rezná rýchlosť príliš vysoká	Znížte reznú rýchlosť. Dodržiavajte odporúčania z katalógu, alebo Selectoru
	Povrch sa obrábaním vytvrdzuje	Znížte rýchlosť. Použite povlakovaný nástroj. Použite kvalitný lubrikant. Pozri kapitola o obrábaní nereze v technickej príručke
	Predvrtaná diera príliš malá	Zväčšite priemer vrtáku na maximum. Pozri tabuľky vrtákov pod závit
	Vysoký krútiaci moment	Použite závitovaciu hlavu s nastavením krút. momentu
	Materiál sa po závitovaní sťahuje	Skontrolujte odporúčania v katalógu, alebo Selectore, nájdite vhodný typ závitníka
Rýchle opotrebovanie	Nevhodný typ závitníku na danú aplikáciu	Zvoľte závitník s menším uhlom čela. Zvoľte závitník s dlhším nábehom. Do priechodných dier používajte závitník s priamou drážkou, do slepých špirálovitý, zabránite zasekávaniu triesok. Skontrolujte v katalógu alebo Selectori alternatívne vhodné závitníky.
	Nedostatočná lubrikácia	Použite kvalitný lubrikant, ktorý predíde zasekávaniu triesok v diere a teplotnému zaťaženiu doštičky. Pozri kapitola o lubrikácii v technickej príručke
	Rezná rýchlosť príliš vysoká	Znížte reznú rýchlosť. Dodržiavajte odporúčania z katalógu, alebo Selectoru.
Nárastok	Nevhodný typ závitníka na danú aplikáciu	Použite závitník s menším uhlom čela alebo/a väčším odľahčením zubov. Skontrolujte katalóg alebo Selector, nájdite vhodný nástroj.
	Nedostatočná lubrikácia	Použite kvalitný lubrikant, ktorý predíde zasekávaniu triesok v diere a teplotnému zaťaženiu doštičky. Pozri kapitola o lubrikácii
	Nevhodná povrchová úprava	Vyberte závitník s odporúčanou povrchovou úpravou
	Rezná rýchlosť príliš nízka	Dodržiavajte odporúčania z katalógu alebo Selectoru

FRÉZOVANIE

VŠEOBECNÉ POKYNY K FRÉZOVANIU

Frézovanie je proces, kedy sa odoberá stanovený prídavok materiálu frézou, ktorá rotuje okolo svojej osi a zároveň sa posúva do rezu.

Fréza je obvykle viacbrity nástroj, kde každá doštička odoberá materiál.

TYPY FRÉZ

Rozlišujeme tri základné druhy frézovacích operácií a tým aj druhy fréz: (A) obvodové frézovanie, (B) čelné frézovanie a (C) frézovanie stopkovými frézami.

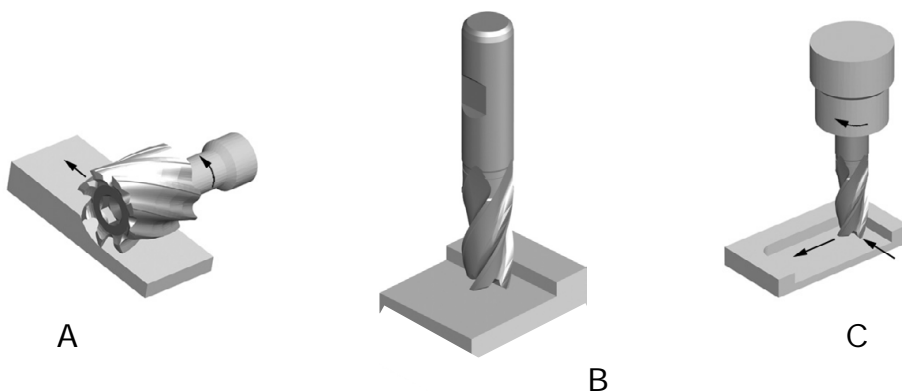

Pri obvodovom frézovaní valcovými frézami je osa rotácie nástroja rovnobežná s povrchom obrábanej časti. Fréza má po obvode zuby, každý z týchto zubov funguje rovnako ako jednobrity nástroj. Valcové frézy môžu mať priame zuby, alebo zuby skrutkovicové.

Pri čelnom frézovaní je osa otáčania frézy kolmá na povrch obrábanej časti. Frézovanie prebieha na britoch, ktoré sú na čele a na obvode frézy.

Pri frézovaní stopkovými frézami je osa frézy vertikálne kolmá na povrch obrobku a obvykle môže frézovať všetkými smermi, ktoré sú na čele a na obvode frézy.

POUŽITIE

Druh obrábacej operácie priamo súvisí s hodnotou Q. Rôzne aplikácie umožňujú dosiahnuť rôzne hodnoty Q. Aktuálny katalóg Dormer ukazuje prostredníctvom jednoduchých ikon použitie fréz.

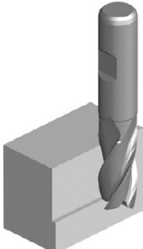
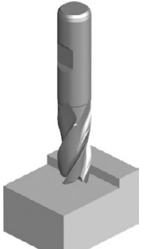
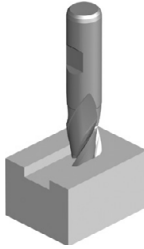
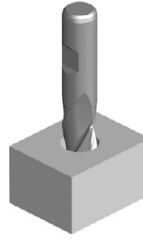
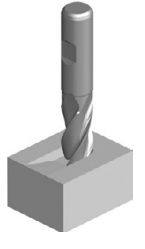
Frézovanie bokom	Čelné frézovanie	Frézovanie drážok	Zapichovacie frézovanie	Zachádzanie pod uhlom
				
Radiálna hĺbka by mala byť menšia než 0,25 x priemer frézy.	Radiálna hĺbka by nemala byť vyššia než 0,9 x priemer frézy, axiálna hĺbka rezu menej než 0,1 x priemer.	Obrábanie drážok na perá. Radiálna hĺbka sa rovná priemeru frézy.	Je možné zavrtávať s frézami, ktoré majú brit cez stred. V týchto operáciách je potrebné znížiť posuv na polovicu.	Zachádzanie pod uhlom, radiálny a axiálny nájazd do materiálu.

RIEŠENIE PROBLÉMOV PRI FRÉZOVANÍ

Problém	Dôsledok	Riešenie
Zlomenie	Príliš veľký prídavok materiálu	Znížte posuv na zub
	Príliš veľký posuv	Znížte posuv
Opotrebovanie	Dĺžka pracovnej časti alebo celková dĺžka príliš dlhá	Upnite tak, aby fréza zbytočne nevytříčala z upínača, alebo použite kratšiu frézu
	Pritvrdomý materiál obrobku	Skontrolujte katalóg, alebo Selector, či je v ponuke odolnejší nástroj, alebo nástroj s povlakom
	Nesprávna rezná rýchlosť a posuv	Skontrolujte rezné dáta v katalógu, alebo Selectore
	Zlý odvod triesok	Správne nastavte trysky s chladením
	Nesúsledné frézovanie	Súsledné frézovanie
	Nevhodná skrutkovica	Skontrolujte odporúčanie v katalógu/Selector a alternatívne nástroje
Vylamovanie	Príliš veľký posuv	Znížte posuv
	Vylamovanie	Znížte reznú rýchlosť
	Nízka rezná rýchlosť	Zvýšte reznú rýchlosť
	Nesúsledné frézovanie	Súsledné frézovanie
	Tuhosť nástroja	Vyberte kratšiu frézu, alebo stopku zasuňte hlbšie do upínača
	Tuhosť obrobku	Pevne upnite obrobok
Krátka životnosť	Húževnatý materiál obrobku	Skontrolujte katalóg, alebo Selector a vyberte alternatívnu frézu
	Nevhodná geometria frézy	Zadajte správne rezné dáta
	Trenie medzi frézou a povrchom obrobku	Použite povlakovaný nástroj
Zlá kvalita povrchu	Príliš veľký posuv	Znížte reznú rýchlosť
	Nízky posuv	Zvýšte reznú rýchlosť
	Zasekávanie triesok	Zmenšite prídavok materiálu
	Opotrebovanie nástroja	Vymeňte, alebo prebrúste nástroj
	Tvorba nárastku	Zvoľte frézu s väčším uhlom skrutkovice
	Nalepovanie triesok	Zvýšte intenzitu chladenia

Problém	Dôsledok	Riešenie
Nepresnosť obrobku	Ohyb nástroja	Zvolte kratší nástroj, alebo zasuňte stopku hlbšie do upínača
	Nedostatočný počet drážok (zubov)	Zvolte nástroj s vyšším počtom drážok (zubov)
	Uvoľnený, opotrebovaný upínač	Opravte, alebo vymeňte
	Nedostatočná tuhosť upínača	Vymeňte za kratší a tuhší upínač
	Nedostatočná tuhosť vretena	Použite výkonnejšie vreteno
Vylamovanie	Rezná rýchlosť a posuv príliš vysoké	Zmeňte rezné dáta s pomocou katalógu/Selectoru
	Dĺžka pracovnej časti alebo celková dĺžka nástroja príliš dlhá	Zasuňte stopku hlbšie do upínača a použite kratšiu frézu
	Prihlboké obrábanie	Znížte hĺbku rezu
	Nedostatočná tuhosť (stroj alebo upínač)	Skontrolujte upínač a ak je potrebné, vymeňte ho

KARBIDOVÉ TECHNICKÉ FRÉZY

VŠEOBECNÉ RADY O KARBIDOVÝCH TECHNICKÝCH FRÉZACH

Karbidové technické frézy sa bežne používajú na prípravu a konečnú úpravu komponentov v širokej škále materiálov.

Obvykle sa používajú manuálne a sú namontované v pneumatických rotačných zariadeniach

VLASTNOSTI A PREDNOSTI

Spevnené a tvrdené oceľové stopky zlepšujú tuhosť a znižujú riziko ohýbania alebo vibrácií

Presne vybrúsené stopky zlepšujú držanie a znižujú pravdepodobnosť pretáčania

Špeciálne spájkovacie prvky zabraňujú poruche v dôsledku vysokej teploty a tiež poskytujú zvýšenú pevnosť, aby odolali tlaku a nárazom

Univerzálna geometria Double Cut je vhodná pre širokú škálu materiálov a aplikácií

Geometrie sú tiež vhodné pre špecifické materiály ako sú oceľ (ST), nehrdzavejúca oceľ (VA), hliník (AL) a sklola-minát (GRP)

K dispozícii s vrstvou TiAlN na zvýšenie životnosti nástroja v abrazívnych materiáloch

Technické frézy sú brúsené s geometriou Skip Flute

To poskytuje aktívnu geometriu smerom ku stredu frézy, zlepšuje frézovanie a znižuje pravdepodobnosť usadzovania triesok a upchávania

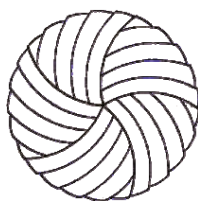

Skoková

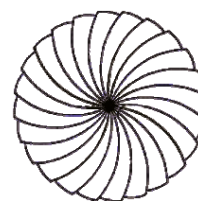

Bežná

BEZPEČNOSŤ NA PRVOM MIESTE

Nástroje rotujúce vysokou rýchlosťou sú nebezpečné a môžu byť nebezpečné, najmä pri nesprávnom používaní

Predtým, ako sa pokúsíte frézy meniť, rotačné zariadenie vždy odpojte od napájania

Skontrolujte stav rotačného zariadenia a, ak je to možné, používajte verzie s nízkymi vibráciami

Vždy používajte vhodné ochranné prostriedky a zabezpečte, aby bol tiež chránený každý, kto pracuje v blízkosti



Osobné ochranné prostriedky sa musia vždy používať.

ODPORÚČANIA

- Vždy používajte rotačné zariadenie s vhodnými otáčkami
- Dôležitá je bežná údržba zariadení. Zaisťte aby boli namazané a ložiská neboli opotrebované
- Pri výmene frézy vyčistite upínaciu maticu, upínanie a vnútorný kužel rotačného zariadenia
- Pokúste sa vyhnúť mechanickým otrasom a silným nárazom
- Pokúste sa vyhnúť teplotným šokom tým, že frézu nebudete prehrievať
- Nevnárajte frézu príliš hlboko do materiálu obrobku, nezasahujte do rohov alebo drážok

Odstraňovanie problémov POUŽÍVANIE TECHNICKÝCH FRÉZ

PROBLÉM	PRÍČINA
Vylamovanie zubov frézy	Pri veľmi nízkych otáčkach môže dochádzať k odsakovaniu
	Excentricita (opotrebované vreteno, upínanie alebo ložiská)
	Vnorenie a uviaznutie frézy do obrobku
Zanášanie zubov frézy	Príliš krátka dĺžka drážky alebo celková dĺžka
	Nesprávna voľba geometrie pre materiál obrobku
Rýchle opotrebovanie	Príliš vysoké prevádzkové otáčky pre danú veľkosť a materiál obrobku
	Excentricita (opotrebované vreteno, upínanie alebo ložiská)
Oddelenie hlavy od stopky	Príliš vysoké prevádzkové otáčky spôsobujúce prehriatie
	Príliš dlhé obrábanie spôsobujúce prehriatie

SIMPLY RELIABLE

Jako odborníci můžete sami pouhým pohledem na třísku posoudit kvalitu odvedené práce. Tříska svým čistým a jednoduchým tvarem v sobě nese příběh. Naše tříska je jasný a neměnný ukazatel a proto je naším symbolem. **Jsme prostě spolehliví.**

Jako profesjonalista możesz ocenić pracę narzędzia po prostu po kształcie wióra. Wiór ma nieskomplikowany wygląd, który sam przekazuje informację. Jest to jasny i logiczny przekaz i dlatego używamy go jako symbol bycia **po prostu godnym zaufania.**

Будучи профессионалом, вы можете оценить качество обработки, просто взглянув на стружку. Чистая и ровная форма стружки говорит сама за себя. Стружка – это точный индикатор стабильности технологического процесса, вот почему мы используем стружку как символ **нашей надежности.**

Ako profesionáli môžete sami iba jednoduchým pohľadom na triesku posúdiť kvalitu odvedenej práce. Trieska svojim čistým a jednoduchým tvarom v sebe nesie príbeh. Preto sa trieska stala jasným a nemenným ukazovateľom a našim symbolom. **Sme jednoducho spoľahliví.**

Argentina

T: 54 (11) 6777-6777
F: 54 (11) 4441-4467
info.ar@dormerpramet.com

Austria

T: +31 10 2080 240
info.at@dormerpramet.com

Belgium & Luxembourg

T: +32 3 440 59 01
info.be@dormerpramet.com

Brazil

T: +55 11 5660 3000
info.br@dormerpramet.com

Canada

T: (888) 336 7637
En Français: (888) 368 8457
F: (905) 542 7000
cs.canada@dormerpramet.com

China

T: +86 21 2416 0508
info.cn@dormerpramet.com

Croatia

T: +385 98 407 489
info.hr@dormerpramet.com

Czech Republic

T: +420 583 381 111
F: +420 583 215 401
info.cz@dormerpramet.com

Denmark

T: 808 82106
info.se@dormerpramet.com

Finland

T: 0205 44 7003
info.fi@dormerpramet.com

France

T: +33 (0)2 47 62 57 01
F: +33 (0)2 47 62 52 00
info.fr@dormerpramet.com

Germany

T: +49 9131 933 08 70
F: +49 9131 933 08 742
info.de@dormerpramet.com

Hungary

T: +36-96 / 522-846
F: +36-96 / 522-847
info.hu@dormerpramet.com

India

T: +91 11 4601 5686
info.in@dormerpramet.com

Italy

T: +39 02 30 70 54 44
info.it@dormerpramet.com

Kazakhstan

T: +7 771 305 11 45
info.kz@dormerpramet.com

Mexico

T: +52 (555) 7293981
F: +52 (555) 7293981
cs.mexico@dormerpramet.com

Netherlands

T: +31 10 2080 240
info.nl@dormerpramet.com

Norway

T: 800 10 113
info.se@dormerpramet.com

Poland

T: +48 32 78-15-890
F: +48 32 78-60-406
info.pl@dormerpramet.com

Portugal

T: +351 21 424 54 21
info.pt@dormerpramet.com

Romania

T: +4(0)730 015 885
info.ro@dormerpramet.com

Russia

T: +7 (495) 775 10 28
Ф: +7 (499) 763 38 90
info.ru@dormerpramet.com

Slovakia

T: +421 (41) 764 54 60
F: +421 (41) 763 74 49
info.sk@dormerpramet.com

Slovenia

T: +385 98 407 489
info.si@dormerpramet.com

Spain

T: +34 935717722
info.es@dormerpramet.com

Sweden responsible for Iceland

T: +46 35 16 52 96
info.se@dormerpramet.com

Switzerland

T: +31 10 2080 240
info.ch@dormerpramet.com

Turkey

T: +90 533 212 45 47
info.tr@dormerpramet.com

Ukraine

T: +38 056 736 30 21
F: +38 067 220 97 48
info.ua@dormerpramet.com

Other countries

South America

T: +55 11 5660 3000
info.br@dormerpramet.com

Adria

T: +420 583 381 527
F: +420 583 381 401
info.rcee@dormerpramet.com

Rest of the World

Dormer Pramet International UK
T: +44 1246 571338
F: +44 1246 571339
info.int@dormerpramet.com

Dormer Pramet International CZ
T: +420 583 381 520
F: +420 583 215 401
info.int.cz@dormerpramet.com